

**CENTRAL AND NORTHERN REGION
FLIGHT INFORMATION PUBLICATION**

INSTRUMENT PROCEDURES VOLUME 1

**(Belgium, Denmark, Norway,
The Netherlands)**

**EFFECTIVE
16 APR 2026 - 10 JUN 2026**



www.cenor.org

SPECIAL NOTICES

Special Notices contain notices of new requirements or major modifications of existing FLIPs. New notices appearing for the first time will be shown first. Notices will be carried in this section for the life of the information. (NOTAM Info and submission deadline are permanent notices.)

Procedures published in CENOR FLIP are subject to national copyright regulations. For detailed information contact the appropriate national CENOR office.

SUBMISSION DEADLINE SCHEDULE

EDITION: 11 JUN 2026	SUBMISSION DEADLINE: 28 APR 2026
EDITION: 06 AUG 2026	SUBMISSION DEADLINE: 23 JUN 2026
EDITION: 01 OCT 2026	SUBMISSION DEADLINE: 18 AUG 2026
EDITION: 26 NOV 2026	SUBMISSION DEADLINE: 13 OCT 2026

FOR LATEST INFORMATION SEE NOTAM

GENERAL INFORMATION

Publishing Authority

The "Central and Northern Region Flight Information Publication" (CENOR FLIP) is a standardized joint publication of the Armed Forces of Belgium, Czech Republic, Denmark, Federal Republic of Germany, Norway, Poland and the Netherlands. It comprises three volumes.

Published by Air Component Command FIFueDst I d.

Revision Cycle 56 days.

Scope

CENOR FLIP contain authorized aerodrome charts, instrument departure and approach procedures required by the above mentioned armed forces. Each armed force is responsible for the correctness of procedures as agreed.

The authorizing agency and the date of edition shall be marked on every procedure. If the preparing armed force is not identical with the authorizing agency, the source of the procedure will be added to the indication, separated by an oblique stroke.

Basic Specifications

- Altitudes, elevations are expressed in ft above MSL unless indicated otherwise.
- Runway dimensions are shown in feet.
- Distances are expressed in nautical miles.
- Visibility values are expressed in kilometers.
- Runway visual range values are expressed in meters.
- Coordinates published based on WGS-84 (World Geodetic System 1984) unless indicated otherwise.
- Courses, headings, radials and bearings are magnetic unless indicated otherwise.
- Information shown within the distance circle is to scale.
- Climb gradients are related to obstacles unless indicated otherwise.
- Runway gradient in percent published when it exceeds 0.5%.

Enquiries and Feedback

All enquiries about delivery of CENOR FLIP and questions concerning procedures are to be addressed to the appropriate national CENOR office. (see page II)

If you like to notify us of any discrepancies or problems you find in the CENOR FLIP or put some constructive suggestions forward on how to improve our service, either contact us via mail or go to <http://www.cenor.org> and leave your feedback in the CENOR forum.

AMENDMENT SERVICE

Amendments will be published by German NOTAM Class I series "U", and/or national NOTAM. Amendment Requests have to be reported via the national FLIP/NOTAM office to:

Section I d, Air Component Command

Directorate - Aeronautical Publications FRANKFURT AM MAIN HAUSEN

AFS: ETCBYFYX
Telephone: +49 69 79307-3212/3214
FspNBw 4260-3212/3214
Telefax: +49 69 79307-3209
FspNBw 4260-3209
E-Mail: milais@bundeswehr.org

National CENOR Offices

Belgium

COMOPSAIR
Airspace Control OPS (A 3.2)
Telephone: +32 2 701-3126
Telefax: +32 2 701-7266
E-Mail: belgium@cenor.org

Denmark

Air Command Denmark
Flight Information Service
Telephone: +45 72811633
E-Mail: denmark@cenor.org

Norway

Royal Norwegian Air Force
Warfare Center
Postal Address:
Postmottak N-2617, Lillehammer, Norway
Telephone: + 47 69 23-7141
E-Mail: ksiggerud@mil.no

The Netherlands

CLSK / AOCS NM /
711 SQN / PPP / PANSOPS
Telephone: +31 20 406 2071 / 2073
E-Mail: netherlands@cenor.org

Czech Republic

Ministerstvo Obrany
Odbor vojenskeho letectvi
Telephone: +420 973210-820 / 826
Telefax: +420 973210-832
E-Mail: czech@cenor.org

Germany

Air Component Command
Section I d - Aeronautical Publications
Telephone: +49 69 79307-3212/3214
Telefax: +49 69 79307-3209
E-Mail: germany@cenor.org

Poland

Military Air Traffic Service
of the Polish Armed Forces
Telephone: +48 22 6 821 157
Telefax: +48 22 6 821 782
E-Mail: poland@cenor.org

TABLE OF CONTENT

PREFACE

I - General Information	30 OCT 2025
II - Amendment Service.....	19 FEB 2026
III - Table of Content.....	16 APR 2026
IV - Table of Content.....	16 APR 2026
V - Table of Content.....	16 APR 2026
VI - Table of Content.....	16 APR 2026
VII - Abbreviations	30 OCT 2025
VIII - Identification of Procedures, Identification of Minima	30 OCT 2025
IX - Altitude Correction.....	30 OCT 2025
X - Landing Minima Explanation	16 APR 2026
XI - Determination of Declared Distances for Runways	16 APR 2026
XII - VASIS/PAPI, LCN, ACN/ PCN System, ACN.....	16 APR 2026
XIII - PCN.....	16 APR 2026
XIV - Legend	30 OCT 2025
XV - Legend	30 OCT 2025
XVI - Legend	30 OCT 2025

AALBORG (EKYT)

AERODROME CHART	16 APR 2026
ILS or LOC RWY 08L	30 OCT 2025
HPMA TACAN RWY 08L.....	23 JAN 2025
TACAN RWY 08L (CAT A-B).....	30 OCT 2025
TACAN RWY 08L (CAT C-E)	30 OCT 2025
RNP RWY 08L	30 OCT 2025
WAYPOINT LIST RWY 08L	26 JAN 2023
ILS or LOC RWY 26R	30 OCT 2025
HPMA VORTAC RWY 26R	03 OCT 2024
VORTAC RWY 26R	30 OCT 2025
RNP RWY 26R	30 OCT 2025
WAYPOINT LIST RWY 26R	03 OCT 2024

AARHUS (EKAH)

AERODROME CHART	03 OCT 2024
RNP RWY 10R	03 OCT 2024
WAYPOINT LIST RWY 10R	07 SEP 2023
ILS or LOC RWY 10R	03 OCT 2024
NDB RWY 10R	03 OCT 2024
RNP RWY 28L	03 OCT 2024
WAYPOINT LIST RWY 28L	07 SEP 2023
ILS or LOC RWY 28L (CAT A-B).....	03 OCT 2024
ILS or LOC RWY 28L (CAT C-E).....	03 OCT 2024
NDB RWY 28L (CAT A-B)	28 NOV 2024
NDB RWY 28L (CAT C-E)	03 OCT 2024

ANDOEYA (ENAN)

AERODROME CHART	25 DEC 2025
LOC M RWY 14	25 DEC 2025
TACAN RWY 14	25 DEC 2025
TACAN RWY 32	25 DEC 2025

ALTA (ENAT)

AERODROME CHART	30 OCT 2025
HPMA ILS or LOC RWY 11.....	19 FEB 2026

BANAK (ENNA)

AERODROME CHART	25 DEC 2025
TACAN SID RWY 16/34	25 DEC 2025
LOC M RWY 16.....	16 APR 2026
TACAN Y RWY 16	16 APR 2026
TACAN Z RWY 16.....	16 APR 2026
HPMA ILS or LOC RWY 34.....	16 APR 2026
ILS M or LOC M RWY 34	16 APR 2026
TACAN Y RWY 34	16 APR 2026
TACAN Z RWY 34.....	16 APR 2026

BARDUFLOSS (ENDU)

AERODROME CHART	25 DEC 2025
HPMA SID RWY 10.....	25 DEC 2025
TACAN SID RWY 10.....	25 DEC 2025
HPMA SID RWY 28.....	25 DEC 2025
TACAN SID RWY 28.....	25 DEC 2025
TACAN RWY 10.....	25 DEC 2025
LOC M RWY 10.....	25 DEC 2025
HPMA ILS or LOC RWY 28.....	25 DEC 2025
ILS M or LOC M RWY 28	25 DEC 2025
TACAN RWY 28.....	25 DEC 2025

BEAUVECHAIN (EBBE)

AERODROME CHART	16 APR 2026
HPMA BE 04A - 04B	16 APR 2026
HPMA BE 04E - 22E	16 APR 2026
HPMA BE 22A - 22B	16 APR 2026
ILS y or LOC y RWY 04L	16 APR 2026
ILS z or LOC z RWY 04L	16 APR 2026
HPMA TACAN RWY 04L	16 APR 2026
TACAN z RWY 04L.....	16 APR 2026
ILS z or LOC z RWY 22R.....	16 APR 2026
TACAN z RWY 22R	16 APR 2026
HPMA STAR TACAN RWY 22 R ..	16 APR 2026

BILLUND (EKBI)

AERODROME CHART	19 FEB 2026
ILS or LOC Z RWY 09.....	16 APR 2026
ILS or LOC Y RWY 09.....	16 APR 2026
RNP RWY 09	16 APR 2026
WAYPOINT LIST RWY 09	02 NOV 2023
ILS or LOC Z RWY 27	16 APR 2026
ILS or LOC Y RWY 27	16 APR 2026
RNP RWY 27	16 APR 2026
WAYPOINT LIST RWY 27	02 NOV 2023

BODOE (ENBO)

AERODROME CHART	30 OCT 2025
HPMA SALTY / HPMA BITNO DEP	25 DEC 2025
HPMA ILS or LOC RWY 07	08 AUG 2024
ILS M or LOC M RWY 07	08 AUG 2024
HPMA TACAN RWY 07	25 DEC 2025
TACAN RWY 07	25 DEC 2025
HPMA ILS or LOC RWY 25	08 AUG 2024
ILS M or LOC M RWY 25	08 AUG 2024
HPMA TACAN A	08 AUG 2024
TACAN A	08 AUG 2024

DE KOOY (EHKD)

AERODROME CHART	16 APR 2026
RNP Y RWY 03	16 APR 2026
RNP Z RWY 03	16 APR 2026
ILS or LOC RWY 21	16 APR 2026
COPTER ILS or LOC RWY 21	16 APR 2026
RNP Y RWY 21	16 APR 2026
RNP Z RWY 21	16 APR 2026

DEELEN (EHDL)

AERODROME CHART	16 APR 2026
TACAN RWY 01	16 APR 2026
COPTER TACAN RWY 01	16 APR 2026
TACAN RWY 19	16 APR 2026
ILS or LOC RWY 19	16 APR 2026
COPTER TACAN 19	16 APR 2026

EINDHOVEN (EHEH)

AERODROME CHART	16 APR 2026
EH 1	16 APR 2026
EH 3	16 APR 2026
EH 5	16 APR 2026
EH 7	16 APR 2026
HI-ILS or LOC RWY 03	16 APR 2026
ILS Z or LOC RWY 03	16 APR 2026
HI-TACAN RWY 03	16 APR 2026
TACAN RWY 03	16 APR 2026
RNP Z RWY 03	16 APR 2026
HI-ILS or LOC RWY 21	16 APR 2026
ILS Z or LOC RWY 21	16 APR 2026
HI-TACAN RWY 21	16 APR 2026
TACAN RWY 21	16 APR 2026
RNP Z RWY 21	16 APR 2026

ESBJERG (EKEB)

AERODROME CHART	20 MAR 2025
ILS or LOC Y RWY 08	16 APR 2026
ILS or LOC Z RWY 08	16 APR 2026
ILS or LOC Y RWY 26	16 APR 2026
ILS or LOC Z RWY 26	16 APR 2026

EVENES (ENEV)

AERODROME CHART	30 OCT 2025
HPMA SID RWY 17/35	25 DEC 2025
TACAN SID RWY 17/35	25 DEC 2025
HPMA TACAN RWY 17	30 OCT 2025
TACAN RWY 17	30 OCT 2025
HPMA ILS or LOC RWY 17	30 OCT 2025
ILS M or LOC M RWY 17	30 OCT 2025
HPMA TACAN RWY 35	30 OCT 2025
HPMA TACAN A	30 OCT 2025
TACAN A	30 OCT 2025

FLORENNES (EBFS)

AERODROME CHART	16 APR 2026
FS 08A - 26A	16 APR 2026
FS 08B - 26B	16 APR 2026
FS 08C - 26C	16 APR 2026
HPMA FS 08D - 08E	16 APR 2026
HPMA FS 26D - 26E	16 APR 2026
HPMA-TACAN RWY 08L	16 APR 2026
TACAN RWY 08L	16 APR 2026
HPMA-ILS or HPMA-LOC RWY 08L	16 APR 2026
ILS or LOC RWY 08L	16 APR 2026
HPMA-ILS or HPMA-LOC RWY 26R	16 APR 2026
ILS or LOC RWY 26R	16 APR 2026
HPMA-TACAN RWY 26R	16 APR 2026
TACAN RWY 26R	16 APR 2026

GARDERMOEN (ENGM)

AERODROME CHART	20 MAR 2025
HPMA ILS or LOC RWY 01L	20 MAR 2025
HPMA ILS or LOC RWY 01R	20 MAR 2025
HPMA ILS or LOC RWY 19L	20 MAR 2025
HPMA ILS or LOC RWY 19R	20 MAR 2025

GILZE-RIJEN (EHGR)

AERODROME CHART	16 APR 2026
GR 1	16 APR 2026
GR 3	16 APR 2026
COPTER TACAN 007	16 APR 2026
HI-TACAN RWY 10	16 APR 2026
TACAN RWY 10	16 APR 2026
COPTER TACAN 100	16 APR 2026
COPTER TACAN 203	16 APR 2026
ILS or LOC RWY 28	16 APR 2026
HI-TACAN RWY 28	16 APR 2026
TACAN RWY 28	16 APR 2026
COPTER TACAN 276	16 APR 2026

HELCHTEREN RANGE

see KLEINE-BROGEL

KARUP AIR BASE (EKKA)

AERODROME CHART	16 APR 2026
ILS or LOC RWY 09R	19 FEB 2026
HPMA TACAN RWY 09R	19 FEB 2026
RNP RWY 09R	19 FEB 2026
WAYPOINT LIST RWY 09R	26 JAN 2023
ILS or LOC RWY 27L	19 FEB 2026
HPMA TACAN RWY 27L	19 FEB 2026
RNP RWY 27L	19 FEB 2026
WAYPOINT LIST RWY 27L	26 JAN 2023

KJEVIK (ENCN)

AERODROME CHART	30 OCT 2025
ILS M or LOC M RWY 03	30 OCT 2025

KLEINE-BROGEL (EBBL)

AERODROME CHART	16 APR 2026
HPMA BL 05A - 05B	16 APR 2026
HPMA BL 05E-23E	16 APR 2026
BL 05A - 05B	16 APR 2026
HPMA BL 23A - 23B	16 APR 2026
BL 23F	16 APR 2026
PAMPA	16 APR 2026
REMB CORRIDOR SB or NB	16 APR 2026
HPMA-ILS or HPMA-LOC RWY 05L	16 APR 2026
ILS z or LOC z RWY 05L	16 APR 2026
ILS y or LOC y RWY 05L	16 APR 2026
HPMA-TACAN RWY 05L	16 APR 2026
TACAN z RWY 05L	16 APR 2026
TACAN y RWY 05L	16 APR 2026
HPMA-ILS or HPMA-LOC RWY 23R	16 APR 2026
ILS or LOC RWY 23R	16 APR 2026
HPMA-TACAN RWY 23R	16 APR 2026
TACAN RWY 23R	16 APR 2026

KOKSIJDE (EBFN)

AERODROME CHART	19 MAR 2026
FN 11 - 29	16 APR 2026
FN 11 COPTER - 29 COPTER	16 APR 2026
HPMA-TACAN RWY 29	16 APR 2026
TACAN RWY 29	16 APR 2026
VOR RWY 29	16 APR 2026

LEEWARDEN (EHLW)

AERODROME CHART	16 APR 2026
LW 1	16 APR 2026
LW 3	16 APR 2026
LW 5	16 APR 2026
LW 7	16 APR 2026
ILS or LOC RWY 05	16 APR 2026
HI-TACAN RWY 05	16 APR 2026
TACAN RWY 05	16 APR 2026
COPTER ILS or LOC 053	16 APR 2026
COPTER TACAN 055	16 APR 2026
RNP Y RWY 05	16 APR 2026
RNP Z RWY 05	16 APR 2026
ILS or LOC RWY 09	16 APR 2026
HI-TACAN RWY 09	16 APR 2026
TACAN RWY 09	16 APR 2026
ILS or LOC RWY 23	16 APR 2026
HI-TACAN RWY 23	16 APR 2026
TACAN RWY 23	16 APR 2026
COPTER ILS or LOC 233	16 APR 2026
COPTER TACAN 229	16 APR 2026
RNP Y RWY 23	16 APR 2026
RNP Z RWY 23	16 APR 2026
ILS or LOC RWY 27	16 APR 2026
HI-TACAN RWY 27	16 APR 2026
TACAN RWY 27	16 APR 2026

ODENSE / H C ANDERSEN (EKOD)

AERODROME CHART	30 OCT 2025
RNP RWY 06	13 JUN 2024
WAYPOINT LIST RWY 06	26 JAN 2023
ILS or LOC RWY 24	13 JUN 2024
RNP RWY 24	13 JUN 2024
WAYPOINT LIST RWY 24	26 JAN 2023

OERLAND (ENOL)

AERODROME CHART	25 DEC 2025
HPMA SID RWY 15 / 33	25 DEC 2025
HPMA ILS OR LOC RWY 15	25 DEC 2025
ILS M or LOC M RWY 15	25 DEC 2025
TACAN RWY 15	25 DEC 2025
TACAN RWY 15Y	25 DEC 2025
HPMA ILS or LOC RWY 33	25 DEC 2025
ILS M or LOC M RWY 33	25 DEC 2025
TACAN RWY 33	25 DEC 2025
TACAN RWY 33Y	25 DEC 2025

PAMPA

see KLEINE-BROGEL

REMB CORRIDOR

see KLEINE-BROGEL

ROENNE (EKRN)

AERODROME CHART	19 FEB 2026
ILS or LOC RWY 11	16 APR 2026
ILS or LOC RWY 29	19 FEB 2026

ROSKILDE (EKRK)

AERODROME CHART	19 FEB 2026
ILS or LOC RWY 11 (CAT A-B).....	28 DEC 2023
ILS or LOC RWY 11 (CAT C-E).....	28 DEC 2023
NDB RWY 11 (CAT A-B).....	28 DEC 2023
NDB RWY 11 (CAT C-E).....	28 DEC 2023
ILS or LOC RWY 21	28 DEC 2023

RYGGE (ENRY)

AERODROME CHART	20 MAR 2025
SID EAST	20 MAR 2025
SID WEST	20 MAR 2025
TACAN RWY 12	19 FEB 2026
HPMA ILS or LOC RWY 30	20 MAR 2025
ILS M or LOC M RWY 30	20 MAR 2025
TACAN RWY 30	19 FEB 2026

SKRYDSTRUP (EKSP)

AERODROME CHART	19 FEB 2026
ILS or LOC RWY 10L	19 FEB 2026
ILS or LOC Z RWY 10L	16 APR 2026
HPMA TACAN RWY 10L.....	19 FEB 2026
TACAN RWY 10L	19 FEB 2026
RNP RWY 10L.....	19 FEB 2026
WAYPOINT LIST RWY 10L.....	26 JAN 2023
ILS or LOC RWY 28R.....	19 FEB 2026
ILS or LOC Z RWY 28R.....	16 APR 2026
HPMA TACAN RWY 28R	19 FEB 2026
TACAN RWY 28R.....	19 FEB 2026
RNP RWY 28R	19 FEB 2026
WAYPOINT LIST RWY 28R	26 JAN 2023

TORP (ENTO)

AERODROME CHART	30 OCT 2025
ILS or LOC M RWY 18	30 OCT 2025

VIGRA (ENAL)

AERODROME CHART	08 AUG 2024
-----------------------	-------------

VLIEHORS RANGE (EHVL)

VL 1	16 APR 2026
VL 2	16 APR 2026

VOLKEL (EHVK)

AERODROME CHART	16 APR 2026
VK 1	16 APR 2026
VK 2	16 APR 2026
VK 3	16 APR 2026
VK 5	16 APR 2026
VK 6	16 APR 2026
VK 7	16 APR 2026
ILS or LOC RWY 06L	16 APR 2026
TACAN RWY 06L - 06R	16 APR 2026
ILS or LOC RWY 24R.....	16 APR 2026
TACAN RWY 24R - 24L	16 APR 2026

WOENSDRECHT (EHWO)

AERODROME CHART	16 APR 2026
WO 1	16 APR 2026
WO 3	16 APR 2026
ILS or LOC RWY 07	16 APR 2026
HI-TACAN RWY 07	16 APR 2026
TACAN RWY 07	16 APR 2026
RNP RWY 07	16 APR 2026
ILS or LOC RWY 25	16 APR 2026
HI-TACAN RWY 25	16 APR 2026
TACAN RWY 25.....	16 APR 2026
RNP RWY 25	16 APR 2026

ABBREVIATIONS

ICAO and NATO abbreviations are used in the CENOR FLIP.
Additionally the following abbreviations are used.

ASI	Approach slope indicator
Descent GR	Descent gradient for non-precision approach is calculated from FAF or last stepdown fix to THR except for procedures according ICAO PANS-OPS where the Descent Gradient is calculated to 50ft above THR elevation.
HPMA	High performance military aircraft
LOC	Localizer
MAP	Missed approach point (=MAPt)
OTCH	End of overrun crossing height
RDR	RADAR
RPI	Runway point of intercept The point where the straight line extension of the glide slope intercepts the runway surface at runway centerline. Note: The RPI is generally located behind the THR. In exceptional cases only it is located in front of the THR. It is then indicated as follows: + In front of the THR
TDZE	Touchdown zone elevation

IDENTIFICATION OF PROCEDURES

Procedures are designed according criteria as stated on top of the procedure. For detailed info about the criteria the applicable documents should be consulted.

PANS-OPS

Procedures according ICAO Doc 8168 OPS Vol II.

MIPS

Procedures according NATO military instrument procedures standardization implemented by the current version of AATCP-1.

TERPS

Procedures according APATC-1(A). No longer updated after 22 OCT 2008.

NATIONAL XXX

Some nations have a special set of criteria for their procedures. If there are significant deviations from PANS-OPS not covered by the criteria specified above the procedure should be marked "NATIONAL" with the three-letter national code. Planning to fly such procedures, the flight crew must consult the national regulations.

IDENTIFICATION OF MINIMA

Visibility minima are stated on the left side of the minima table. For detailed info about the criteria the applicable documents should be consulted.

EU-OPS

Minima assigned in accordance with EU-OPS.

MIPS

Minima assigned according NATO military instrument procedures standardization implemented by the current version of AATCP-1.

TERPS

Minima assigned according former NATO military criteria (APATC-1(A)). No longer updated after 22 OCT 2008.

NATIONAL XXX

Minima assigned according national specific criteria marked "NATIONAL" with the three-letter national code. Planning to fly such procedures, the flight crew must consult the national regulations.

ALTITUDE CORRECTION

To be used according to national regulations

Pressure Altimeter Errors

International Standard Atmosphere (ISA) is used as a basis for the altitude corrections below. ISA temperature at sea level is +15 degrees Celsius, decreasing 2 degrees per 1000 feet above sea level. When actual temperature is lower than ISA, the aircraft will be lower than indicated in its pressure altimeter. Under such circumstances, a compensation should be added to altitudes flown during the approach procedure. The altimeter error is approximately 0.4% of aircraft height above reference datum (AD) per degree C below ISA. When AD temperature is 0 degrees or colder, values in the Altitude Correction Chart should be added to:

- a) All procedure altitudes below Transition Level (TL), and ATC assigned IFR altitudes, if not already compensated.
- b) Minimum Sector Altitudes (MSA) and Emergency Safe Altitudes.

Pilots must advise ATC when temperature correction is applied, and state amount of correction or new altitude to be flown.

Altitude Correction Chart

A / D TEMP C	HEIGHT ABOVE THE ALTIMETER SOURCE (FEET)											
	200	300	400	500	600	700	800	900	1000	1500	2000	2500
0°	20	20	30	30	40	40	50	50	60	90	120	140
-10°	20	30	40	50	60	70	80	90	100	150	200	240
-20°	30	50	60	70	90	100	120	130	140	210	280	350
-30°	40	60	80	100	120	130	150	170	190	280	380	470
-40°	50	80	100	120	150	170	190	220	240	360	480	600
-50°	60	90	120	150	180	210	240	270	300	450	590	740
	3000	3500	4000	4500	5000	5500	6000	6500	7000	7500	8000	
0°	170	200	230	260	280	310	340	370	400	430	460	
-10°	290	340	390	440	490	540	590	640	690	740	790	
-20°	420	500	570	640	710	780	850	930	1000	1070	1150	
-30°	570	660	760	850	950	1050	1140	1240	1340	1440	1540	
-40°	720	840	970	1090	1210	1330	1460	1580	1710	1830	1960	
-50°	890	1040	1190	1340	1500	1650	1800	1960	2110	2270	2420	

VALUES TO BE ADDED TO PUBLISHED ALTITUDES

Note: The table is calculated for sea level AD. Values are conservative when applied at higher AD. values are calculated with reference to ICAO Doc 8168 Vol 3, Section 2 Chapter 4, and rounded up to nearest 10 ft.

Example: HI-TACAN RWY 10, BARDFOSS (ENDU), AD elevation 252 ft, AD temperature -30° Celsius.

	Published ALT	HAA	*Correction	**Indicated ALT
20 DME	6000	5748	1100	7100
15 DME	4900	4648	900	5800
12 DME	4000	3748	720	4800
FAF	3100	2848	540	3700
6 DME	1900	1648	320	2300
MDA	1420	1168	240	1660

* Rounded up to next 20ft. ** Altitude to be flown. Rounded up to next higher 100ft increment, except DA/MDA.

Wind Induced Altimeter Errors

Strong winds moving over mountain crests and ridges causes local drops in static pressure (known as the Bernoulli effect), which may induce pressure altimeter errors (altimeter showing higher than actual altitude). As these errors will vary greatly with aircraft position relative to terrain, it is not possible to make an exact calculation, but the pilot in command will be responsible for evaluating whether a correction would be necessary.

LANDING MINIMA EXPLANATION

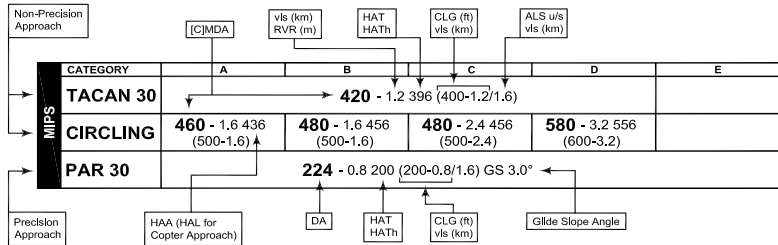

CLG

Ceiling

A ceiling is expressed in feet above the published aerodrome elevation, and is equal to or greater than the height of the associated DA or MDA.

DA

Decision Altitude

The altitude related to the highest elevation in the touchdown zone specified for a glide slope approach, at which a missed approach must be initiated if required visual reference has not been established.

HAA

Height above Aerodrome Elevation

The height of the MDA above the published aerodrome elevation. HAA will be published in conjunction with all circling minima.

HAT

Height above Touchdown Zone Elevation

The height of the DA or MDA above the highest runway centerline elevation in the touchdown zone. Published in TERPS procedures where heights are referenced to touchdown zone elevation.

HATH

Height above Threshold Elevation

The height of the DA or MDA above the threshold. Published in PANS-OPS/ MIPS procedures where heights are referenced to threshold elevation.

[C]MDA

[Circling] Minimum Descent Altitude

The MDA is the lowest altitude to which descent shall be authorized in procedures not using a glide slope. Aircraft are not authorized to descend below the MDA until the runway environment is in sight, and the aircraft is in a position to descend for normal landing.

VIS/RVR

Visibility values are expressed as visual range (estimated horizontal visual range on the ground = VIS) or as runway visual range (measured horizontal visual range on the ground along the runway = RVR). The visibility values published following the DA or MDA is the required minimum visibility for the approach. For straight-in approaches, the visibility value may be either VIS or RVR. For circling approaches, the visibility value will always be VIS. The visibility value published in parentheses with the ceiling value is applicable for flight planning purpose. It is also the required minimum visibility in the event that RVR is not available. For ALS u/s, the last VIS value (behind the slash) should be used. The value will always be VIS.

DETERMINATION OF DECLARED DISTANCES FOR RUNWAYS

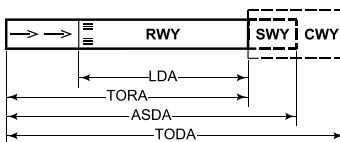
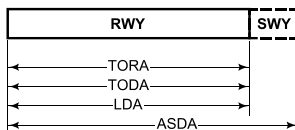
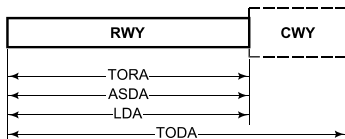
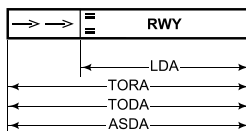
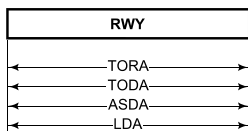

SWY Stopway

A defined rectangular area on the ground at the end of takeoff run available prepared as a suitable area in which an aircraft can be stopped in case of an aborted takeoff.

CWY Clearway

A defined rectangular area on the ground or water at the end of a runway in the direction of takeoff and under control of an appropriate authority, selected or prepared as a suitable area over which an aircraft may make a portion of its initial climb to a specified height, (extension laterally to a distance of at least 75 m either side of extended runway centerline and not longer than half length of runway).

TORA Takeoff Run Available

The length of runway declared available and suitable for the ground run of an aircraft taking off.

TODA Takeoff Distance Available

The length of the takeoff run available plus the length of the clearway, if provided.

ASDA Accelerate Stop Distance Available

The length of the takeoff run available plus the length of the stopway, if provided.

LDA Landing Distance Available

The length of runway which is declared available and suitable for the ground run of an aircraft landing. The LDA commences at the threshold/displaced threshold.

VASIS / PAPI

V VASI (VISUAL APPROACH SLOPE INDICATOR)

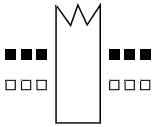

On correct approach path

□ White ■ Red

Visual Approach Slope Indicator with standard threshold clearance provided.

All lights WHITE - TOO HIGH
 Far lights RED, near lights WHITE - ON GLIDE SLOPE
 All lights RED - TOO LOW

P PAPI (PRECISION APPROACH PATH INDICATOR)

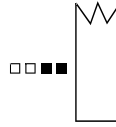

On correct approach path

□ White ■ Red

■■■■ TOO LOW
 □■■■ SLIGHTLY LOW
 □□■■ ON CORRECT APPROACH PATH
 □□□■ SLIGHTLY HIGH
 □□□□ TOO HIGH

PAPI display consists of a 4-light wing-bar on one side of the runway and adjacent to the touchdown point. A symmetrical PAPI display consists of a 4-light wing-bar on each side of the runway.

LOAD CLASSIFICATION NUMBER

At some aerodromes the load-bearing strength of runways/taxiways is defined by Load Classification Numbers (LCN). The LCN has to be determined for the aircraft concerned and compared with the specific runway LCN. Normally the LCN of an aircraft should not exceed that of the runway on which a landing is intended. Exceptions may be allowed by the person responsible for the performance of flight operations.

ACN / PCN SYSTEM

The ACN/PCN System provides a method of classifying pavement bearing strength for aircraft above 5700 kg Maximum Total Weight Authorized (MTWA). The ACN is a number expressing the relative effect of an aircraft load on a pavement for a specified sub-grade strength. The PCN is a number expressing the bearing strength of a pavement for unrestricted operations. Using the ACN/PCN System means to compare the ACN with the PCN.

AIRCRAFT CLASSIFICATION NUMBER (ACN)

The ACN is calculated taking into account the weight of the aircraft, the pavement type, and the sub-grade category. ACN values for GAF aircraft are given in the Flight Manuals for rigid and flexible pavements.

PAVEMENT CLASSIFICATION NUMBER (PCN)

PCN are reported as a five part code. Apart from the numerical value of the PCN, the report includes the pavement type (rigid or flexible) and the sub-grade support strength category. Provision is made in the report for the aerodrome authority to place a limit on maximum allowable tyre pressure, if this is a constraint, and an indication is required of whether the pavement has been evaluated by technical means or by past experience of aircraft use of the pavement.

Details of the coded format and an example are:

- PCN number
- Type of pavement
 - R = Rigid
 - F = Flexible
- Pavement sub-grade category
 - A = High
 - B = Medium
 - C = Low
 - D = Ultra-Low
- Maximum tyre pressure authorized for the pavement
 - W = High, no limit
 - X = Medium, limited to 217 psi
 - Y = Low, limited to 145 psi
 - Z = Very low, limited to 73 psi
- Pavement evaluation method
 - T = Technical evaluation
 - U = By experience of aircraft using the pavement

Example

If the bearing strength of a rigid pavement resting on a medium strength sub-grade has been assessed by a technical evaluation to be a PCN of 80 and there is no tyre pressure limit, then the reported information would be:

PCN: 80 / R / B / W / T

Operating procedure

Provided a pavement PCN is equal to or greater than the ACN of the aircraft unlimited use of the pavement is permitted.























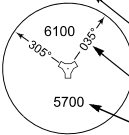



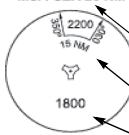



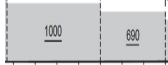







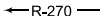

Provided the PCN is smaller than the ACN the use of the pavement by an aircraft can only be undertaken when prior permission of the individual aerodrome authority is granted or by reduction of the aircraft load.

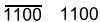
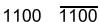
LEGEND



VOR

LEGEND

	VOR		HIRTA (with obstruction unlighted)
	DME		HIRTA (with obstruction lighted)
	VOR/DME		HIRTA High intensity radio transmission area
	TACAN		HIRTA lateral limits
	VORTAC		Power Transmission Line
	NDB	MSA FIX 25 NM	Minimum Sector Altitude (MSA) 25NM radius
	VFR Reporting Point / Intersection On Request Fly-By		Identification of Radio Navigational Facility
	VFR Reporting Point / Intersection Compulsory Fly-By		Sector Boundary
	VFR Reporting Point / Intersection On Request Fly-Over		Minimum sector Altitude (MSA)
	VFR Reporting Point / Intersection Compulsory Fly-Over	MSA GZR 25 NM	Minimum Sector Altitude (MSA) 25NM radius
	Waypoint On Request Fly-By		Identification of Radio Navigational Facility
	Waypoint Compulsory Fly-By		Sector Boundary 15 NM awa from Beacon
	Waypoint On Request Fly-Over		Minimum sector Altitude (MSA)
	Waypoint Compulsory Fly-Over		Minimum obstacle clearance Altitude
	DME Mileage		Danger Area (ED-D) Restricted Area (ED-R) Prohibited Area (ED-P)
	Abandoned or closed Aerodrome		Variation
	Aerodrome Beacon		International Border
	Procedural Track		FIR
	Radial		Control Zone (CTR)
	Lead Radial		Not to Scale
	Mandatory Level / Recommended Level	000.000x	Frequency available on request
	Minimum Level / Maximum Level		ARP
	Spot Elevation		
	Obstruction (unlighted)		
	Group of Obstructions (unlighted)		
	Obstruction (lighted)		
	Group of Obstructions (lighted)		
	HIRTA (no obstruction)		

(27)

Distance



Initial Approach Fix



Missed Approach



Procedure Turn



Fix / Turning Point



Penetration Track



operates not continuously



Final Approach Fix (FAF)
(Non precision approaches)



Visual Descent Point (VDP)



Transition Route



Supplementary Route

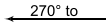

Final Approach Course from IAF to
main Radio NavAid or ARP



Standard Holding Pattern



Holding Fix (If holding fix conform to
IAF, IAF symbol is to be used.)



Glide Slope Intercept Altitude



ILS



Locator at OM



MM



OM



General symbol for radio facilities



Radar reflector



VASIS / PAPI



Displaced Threshold



INS Position



Closed runway or taxiway
TWY



Uni-directional / Bi-directional Cable
The cables are displayed with regard to the direction of their arresting capabilities (uni-/bi-directional) irrespective of flight operational restrictions.



Note Circle (a - i)



TAA



Turning Point (turn when..)



Net



Taxiway designation



ABN



Holding Points



Helicopter Landing Area



Supervision office



Wind sock (unlighted, lighted)



RWY (hard surface)



RWY (unpaved surface)



RWY (unpaved surface) with unpaved surface beyond RWY extremities



RWY (hard surface) with hard surface beyond RWY extremities



RWY (hard surface) with unpaved surface beyond RWY extremities



TWY or apron (hard surface)



Building

APPROACH LIGHTING SYSTEM



Threshold (ALS no flashing lights)
 Threshold (ALS with flashing lights)



Lights on extended rwy center line
 1 row
 2 rows
 3 rows or more



Crossbar



No ALS

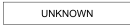

Type of ALS unknown



Example



Example

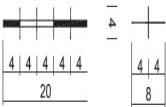

Row of lights on the extended centre line of RWY

AERODROME CHART

AALBORG (EKYT)

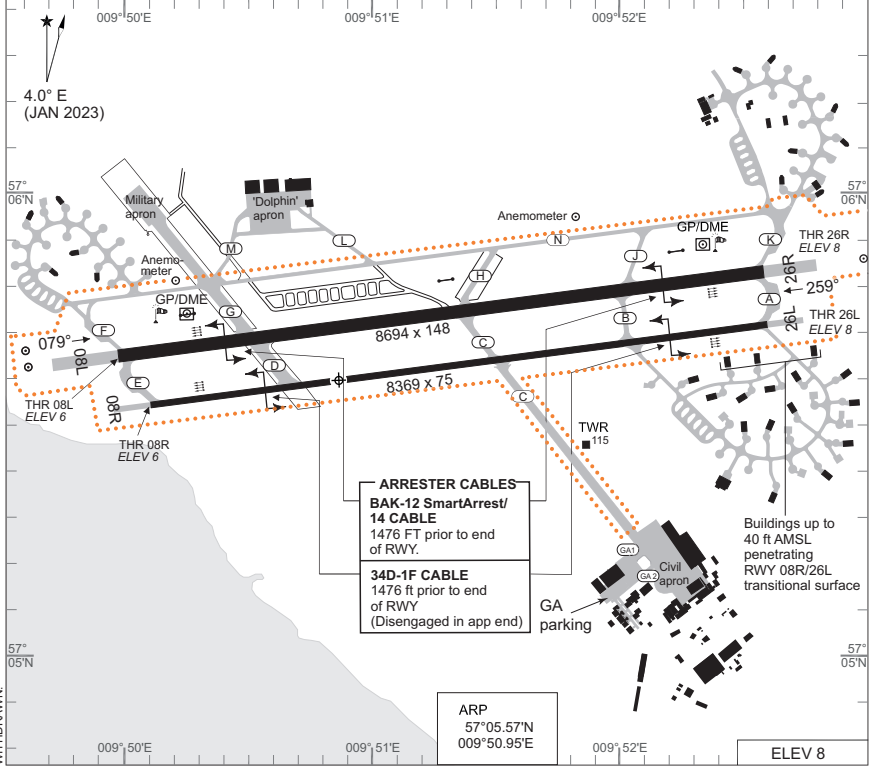

ARRESTER CABLES
BAK-12 SmartArrest/ 14 CABLE
 1476 FT prior to end of RWY.
34D-1F CABLE
 1476 ft prior to end of RWY (Disengaged in app end)

ARP
 57°05.57'N
 009°50.95'E
 ELEV 8

RWY	PCN	DECLARED DISTANCES					PAPI	THR ELEV	THR PSN
		PSN	TORA	TODA	ASDA	LDA			
08L	66 F/D/W/T	E/F	8694	8694	9422	8694	3.0°	6	57°05.623'N 009°50.005'E
		D/G	6791	6791	7519				
		C/H	4002	4002	4730				
26R	52 F/D/X/U	A/K	8694	8694	9589	8694	3.0°	8	57°05.790'N 009°52.611'E
		B/J	6791	6791	7686				
		C/H	4691	4691	5586				
08R	52	E	8369	8369	8861	8369	3.0°	6	57°05.515'N 009°50.128'E
26L	A	A	8369	8369	8861	8369	3.0°	8	57°05.675'N 009°52.634'E

AALBORG TWR: 118.305 353.525 AALBORG ATIS: 120.480
 START UP CLEARANCE REQUIRED H24 - PARACHUTING MAY BE IN PROGRESS!
 STANDARD INSTRUMENT DEPARTURES (SID) HAVE NOT BEEN ESTABLISHED.
 OMNIDIRECTIONAL DEPARTURES RWY 08L/R AND 26R/L: CLIMB STRAIGHT AHEAD TO AT LEAST 600 FT MSL BEFORE TURN IS COMMENCED.

PROC. CRITERIA	RWY	GS	TCH	OTCH	RPI	CAT	MINIMA CRITERIA	MINIMA
PAR	INTENTIONALLY LEFT BLANK							
SRA	INTENTIONALLY LEFT BLANK							

CHANGES: ATC SERVICE BOUNDARY ADDED. LIMIT OF MANOEUVRING AREA WITHDRAWN.

AIR COMMAND DENMARK - MIL-AIM 16 APR 2026

AERODROME CHART

AALBORG (EKYT)

MIPS

INSTRUMENT APPROACH CHART

AD ELEV 8

ILS or LOC RWY 08L
AALBORG (EKYT)

COPENHAGEN CONTROL 242.650 124.555		AALBORG ATIS 120.480	AALBORG APPROACH 362.450 123.980		AALBORG TOWER 353.525 118.305		
LOC/DME AE 109.90/CH 36x	VORTAC AAL CH114x/116.700	APP COURSE 079°	FAF ALT 2300 FT	GS 3.00°	DA 206	THR ELEV/ALS LENGTH 6 / 470 M	LDA 8694 FT

NOTES:

- a Circling N of AD only
- b For speeds below 185 KIAS reduce minima to: **206 - 750 200 (200-0.8/1.2)**

DME REQUIRED

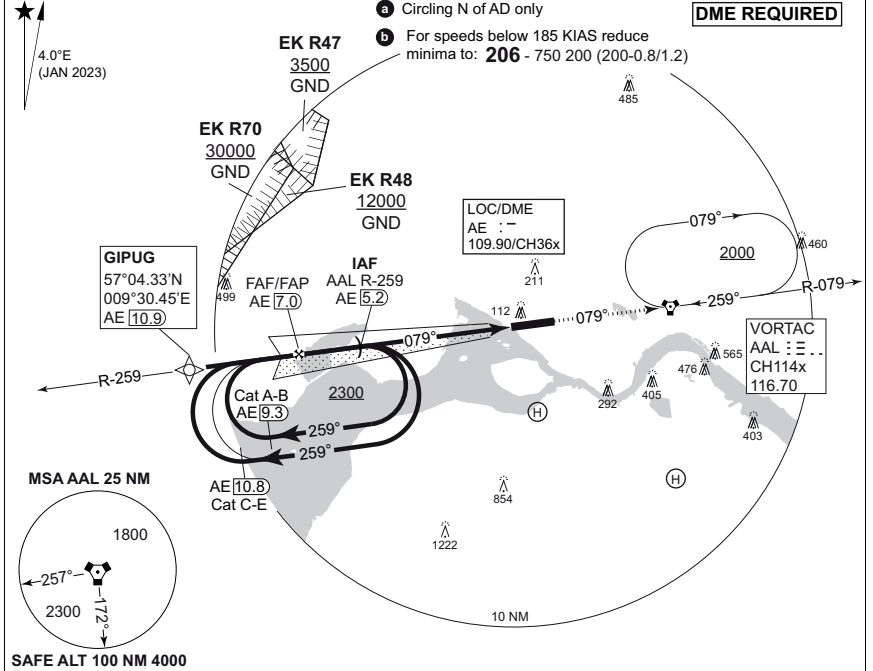

SAFE ALT 100 NM 4000

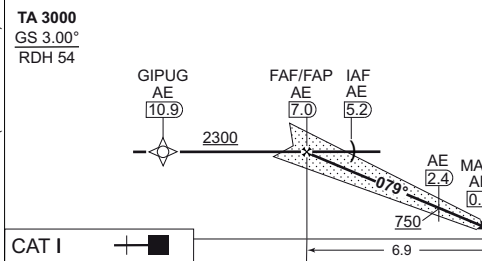

LOC ONLY: CDFEA 3.00° / 5.24%						
DME AE	6	5	4	3	2	1
DIST THR	5.9	4.9	3.9	2.9	1.9	0.9
ALT	1930	1610	1290	970	650	330

MISSED APPROACH
Climb on track 079° to 2000 ft to AAL VORTAC and hold or as instructed by ATC.

CAT I

CATEGORY	A	B	C	D	E
S-ILS CAT I 08L		206 - 750 200 (200-0.8/1.2)			281 -900 275 (300-0.9/1.3) b
S-LOC 08L		300 - 900 292 (300-0.9/1.4)			310 -1000 302 (400-1.0/1.4)
CIRCLING a	510 -1.5 502 (600-1.5)	510 -1.6 502 (600-1.6)	690 -2.4 682 (700-2.4)	750 -3.6 742 (800-3.6)	840 -3.6 832 (900-3.6)

ILS or LOC RWY 08L

57°05.57'N
009°50.95'E

AALBORG (EKYT)

CHANGES: NEW AALBORG HOSPITALSBYEN HELMS (PRIVATE HELIPAD) ADDED.

AIR COMMAND DENMARK - MIL-AIM 30 OCT 2025

MIPS
INSTRUMENT APPROACH CHART

HPMA TACAN RWY 08L
AALBORG (EKYT)

AD ELEV 8

COPENHAGEN CONTROL 242.650 124.555		AALBORG ATIS 120.480		AALBORG APPROACH 362.450 123.980		AALBORG TOWER 353.525 118.305	
TACAN AAL CH 114X	APP COURSE 079°	FAF ALT 2000 FT	DESCENT GR. 5.24% (318 FT/NM)		MDA 340	THR 6	LDA 8694 FT

NOTES:

a Circling North of AD only

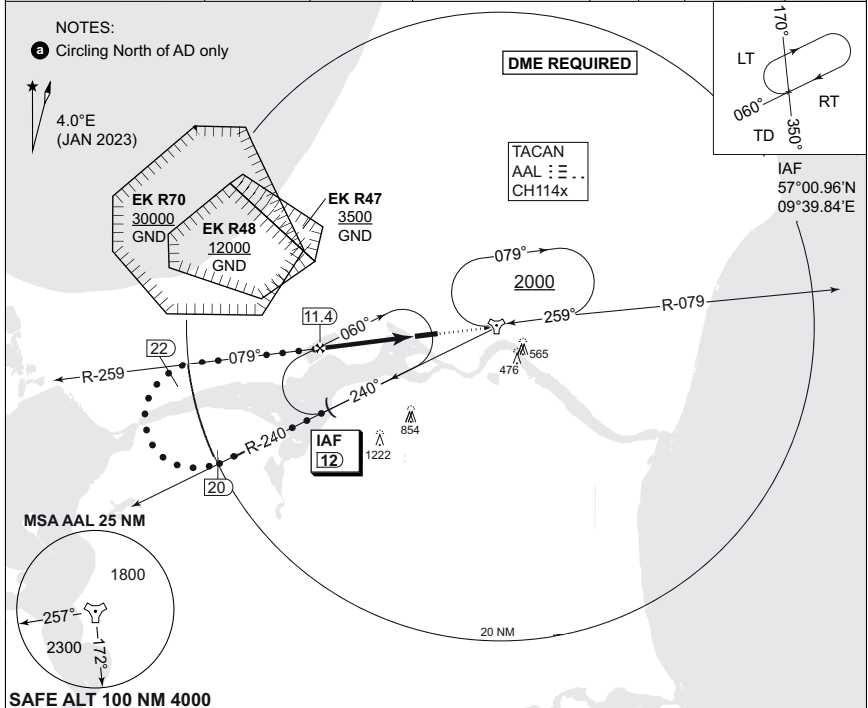

TA 3000

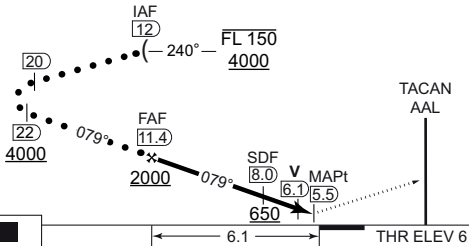

CDFA: 3.00° / 5.24%

DME AAL	11	10	9	8	7
DIST THR	5.7	4.7	3.7	2.7	1.7
ALT	1890	1570	1250	940	620

MISSED APPROACH
Climb on TACAN AAL R-259 to 2000 ft inbound AAL and hold.

CAT I 6.1 THR ELEV 6

CATEGORY	HPMA	
S-TACAN 08L	340 - 1100 332 (400-1.1/1.5)	
CIRCLING a	560 - 3.2 552 (600-3.2)	

HPMA TACAN RWY 08L 57°05.57'N 009°50.95'E **AALBORG (EKYT)**

CHANGES: EDITORIAL

AIR COMMAND DENMARK - MIL-AIM 23 JAN 2025

MIPS

INSTRUMENT APPROACH CHART

TACAN RWY 08L (CAT A-B)

AALBORG (EKYT)

AD ELEV 8

COPENHAGEN CONTROL 242.650 124.555	AALBORG ATIS 120.480	AALBORG APPROACH 362.450 123.980		AALBORG TOWER 353.525 118.305	
TACAN AAL CH 114x	APP COURSE 079°	FAF ALT 2000 FT	DESCENT GR 318 FT/NM	MDA 340	THR 6
	ALS length 470 M	LDA 8694 FT			

4.0° E (JAN 2023) a CIRCLING N OF AD ONLY

DME REQUIRED

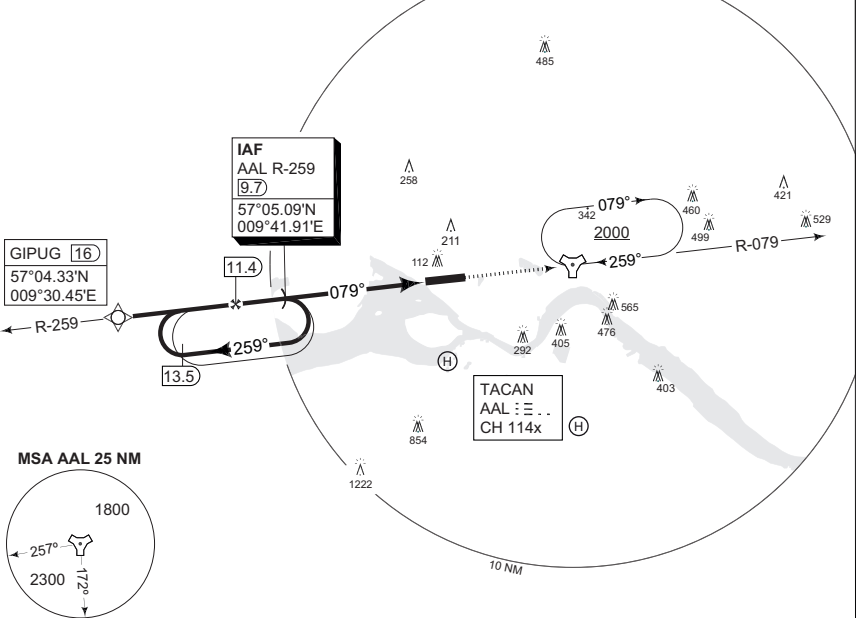

TA 3000

	CDFA 3.0° / 5.24%				
DME AAL	11	10	9	8	7
DIST THR	5.7	4.7	3.7	2.7	1.7
ALT	1890	1570	1250	940	620

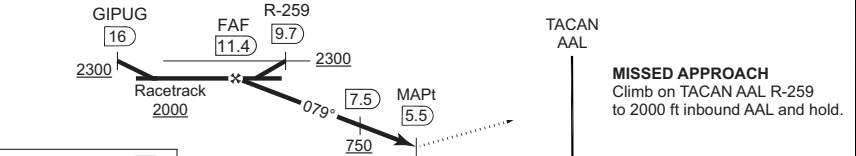

CAT I 6.1 THR ELEV 6

CATEGORY	A	B
----------	---	---

S-TACAN 08L	340 -1100 332 (400-1.1/1.5)	
-------------	-----------------------------	--

CIRCLING a	510 -1.5 502 (600-1.5)	510 -1.6 502 (600-1.6)
------------	------------------------	------------------------

TACAN RWY 08L (CAT A-B) 57°05.57'N
009°50.95'E **AALBORG (EKYT)**

CHANGES: NEW AALBORG HOSPITALSRYEN HELMS (PRIVATE HELIPAD) ADDED.

AIR COMMAND DENMARK - MILAIM 30 OCT 2025

MIPS
INSTRUMENT APPROACH CHART

TACAN RWY 08L (CAT C-E)
AALBORG (EKYT)

AD ELEV 8

COPENHAGEN CONTROL 242.650 124.555	AALBORG ATIS 120.480	AALBORG APPROACH 362.450 123.980		AALBORG TOWER 353.525 118.305	
TACAN AAL CH 114x	APP COURSE 079°	FAF ALT 2000 FT	DESCENT GR 318 FT/NM	MDA 340	THR 6
			ALS length 470 M	LDA 8694 FT	

a CIRCLING N OF AD ONLY

DME REQUIRED

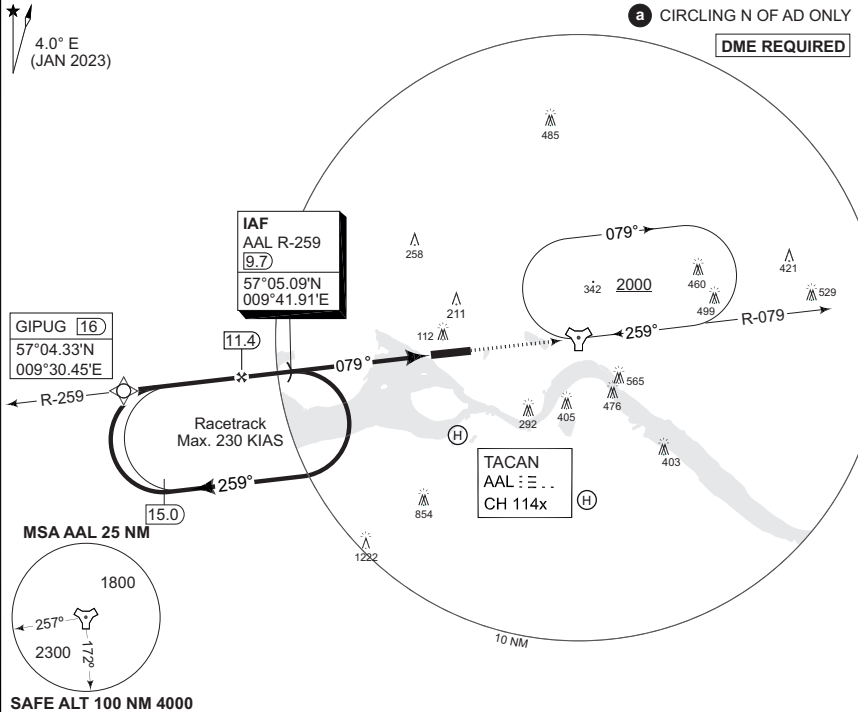

TA 3000

	CDFA 3.0° / 5.24%				
DME AAL	11	10	9	8	7
DIST THR	5.7	4.7	3.7	2.7	1.7
ALT	1890	1570	1250	940	620

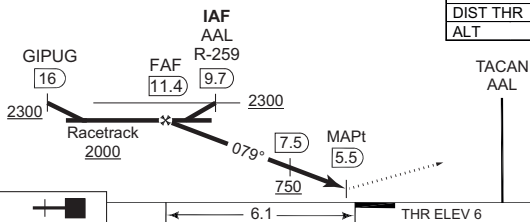

MISSED APPROACH
Climb on TACAN AAL R-259 to 2000 ft inbound AAL and hold.

CAT I

CATEGORY	C	D	E
S-TACAN 08L	340 -1100 332 (400-1.1/1.5)		
CIRCLING a	690 -2.4 682 (700-2.4)	750 -3.6 742 (800-3.6)	840 -3.6 832 (900-3.6)

TACAN RWY 08L (CAT C-E)

57°05.57'N
009°50.95'E

AALBORG (EKYT)

MIPS

INSTRUMENT APPROACH CHART

AD ELEV 8

**RNP RWY 08L
AALBORG (EKY)**

COPENHAGEN CONTROL 242.650 124.555		AALBORG ATIS 120.480	AALBORG APPROACH 362.450 123.980		AALBORG TOWER 353.525 118.305	
APP COURSE 079°	FAF ALT 2000 FT	Descent GR 3.0° (5.24%)	MINIMA See CAT	THR 6	ALS length 470 M	LDA 8694 FT

Notes:

- a) PAPI and RNP glidepath not coincident (PAPI TCH 50 FT, RNP TCH 41 FT)
- b) Not to be used below -30°C.
- c) Circling NORTH of AD only.

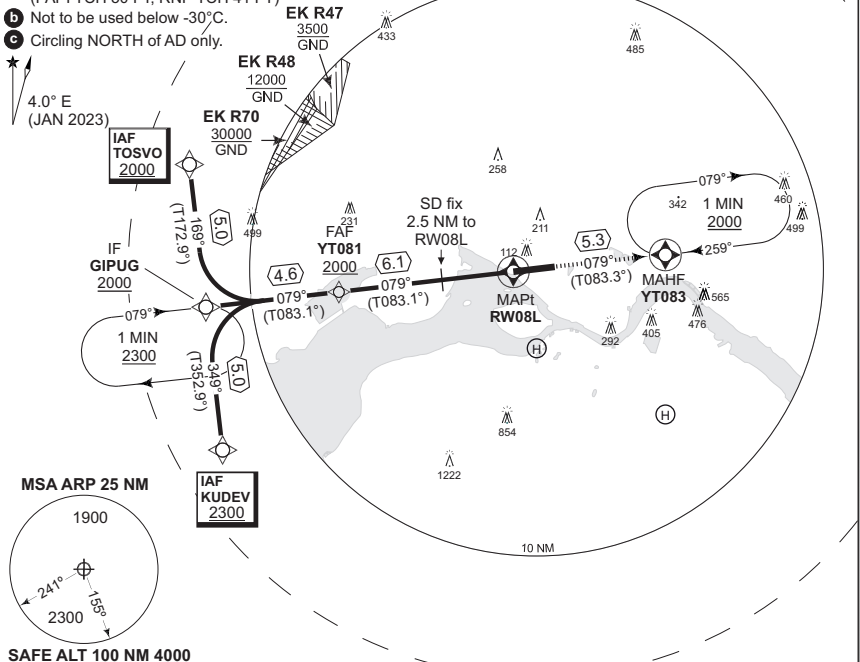

SAFE ALT 100 NM 4000

TA 3000 GS 3.0° TCH 41	CDFA 3.0° / 5.24%						
	DIST TO RW08L	6	5	4	3	2	1
	NOM. ALTITUDE	1960	1650	1330	1010	690	370

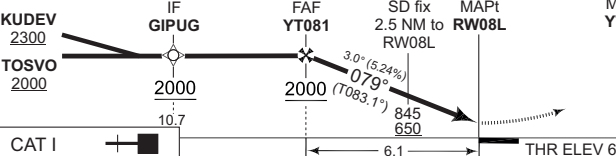

MISSED APPROACH
Climb on track to overfly YT083 and hold at 2000 ft.
RW08L - YT083 [A2000+,HM]

CATEGORY	A	B	C	D	E
LNAV/VNAV (DA) b	256 -800 250 (300-0.8/1.3)			272 -900 266 (300-0.9/1.3)	290 -900 284 (300-0.9/1.4)
LNAV (MDA)	310 -1000 302 (400-1.0/1.4)		330 -1100 322 (400-1.1/1.5)	350 -1200 342 (400-1.2/1.6)	360 -1200 352 (400-1.2/1.6)
CIRCLING c	510 -1.5 502 (600-1.5)	510 -1.6 502 (600-1.6)	690 -2.4 682 (700-2.4)	750 -3.6 742 (800-3.6)	840 -3.6 832 (900-3.6)

RNP RWY 08L

57°05.57'N
009°50.95'E

AALBORG (EKY)

CHANGES: AALBORG HELMS ADDED, NEW AALBORG HOSPITAL, SBYEN HELMS (PRIVATE HELIPAD), ADDED.

AIR COMMAND DENMARK - MILAIM 30 OCT 2025

EKYT RNP RWY 08L waypoint coordinates:

RWY 08L from TOSVO (Initial LEFT) APPROACH RNP

		CODING				DISPLAY	
TOSVO	IAF	57 09 16.80N	009 29 19.21E		57 09.280N	009 29.320E	
GIPUG	IF	57 04 20.00N	009 30 27.00E		57 04.333N	009 30.450E	
YT081	FAF	57 04 53.88N	009 38 54.12E		57 04.898N	009 38.902E	
RW08L	MAPt	57 05 37.37N	009 50 00.30E		57 05.623N	009 50.005E	
YT083	MAHF	57 06 13.39N	009 59 44.08E		57 06.223N	009 59.735E	

RWY 08L from KUDEV (Initial RIGHT) APPROACH RNP

		CODING				DISPLAY	
KUDEV	IAF	56 59 23.12N	009 31 34.48E		56 59.385N	009 31.575E	
GIPUG	IF	57 04 20.00N	009 30 27.00E		57 04.333N	009 30.450E	
YT081	FAF	57 04 53.88N	009 38 54.12E		57 04.898N	009 38.902E	
RW08L	MAPt	57 05 37.37N	009 50 00.30E		57 05.623N	009 50.005E	
YT083	MAHF	57 06 13.39N	009 59 44.08E		57 06.223N	009 59.735E	

Threshold coordinates RWY 08L

	CODING				DISPLAY	
RWY 08L	57 05 37.37N	009 50 00.30E		57 05.623N	009 50.005E	

MIPS

INSTRUMENT APPROACH CHART

AD ELEV 8

ILS or LOC RWY 26R

AALBORG (EKYT)

COPENHAGEN CONTROL 242.650 124.555		AALBORG ATIS 120.480	AALBORG APPROACH 362.450 123.980		AALBORG TOWER 353.525 118.305	
LOC/DME YT 111.55/CH 52y	APP COURSE 259°	GS INCP T ALT 2000 FT	GS 3.00°	DA 208	THR ELEV 8	ALS LENGTH 900 M
				LDA 8694 FT		

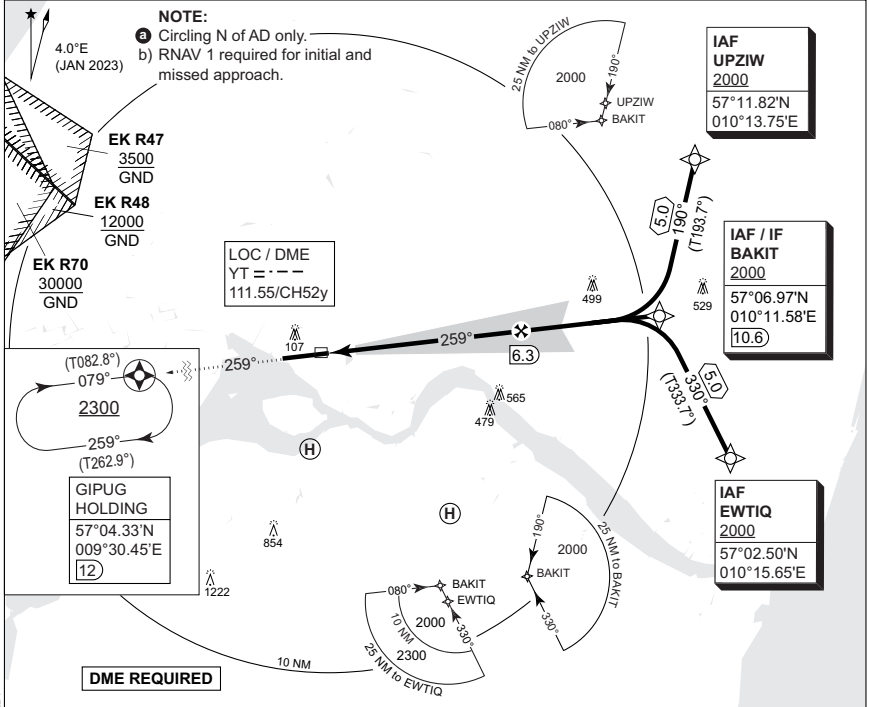

CDFA: 3.00° / 5.24%						TA 3000
DME YT	2	3	4	5	6	GS 3.00°
DIST THR	1.8	2.8	3.8	4.8	5.8	RDH 51
ALT	640	960	1280	1600	1920	

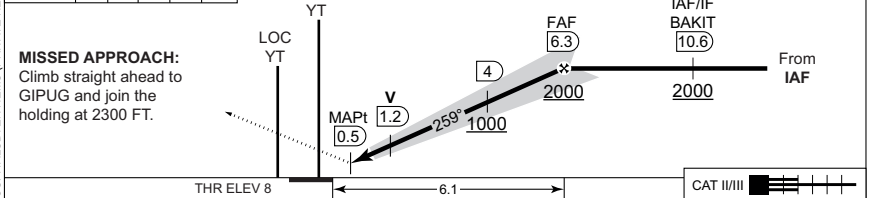

CATEGORY	A	B	C	D	E
S-CAT I	208 - 550 200 (200-0.8/1.2)				
S-CAT II	RA 101 (DA 108) - 350 100				N/A
S-LOC 26R	390 - 1100 382 (400-1.1/1.8)				
CIRCLING a	510 -1.5 502 (600-1.5)	510 -1.6 502 (600-1.6)	690 -2.4 682 (700-2.4)	750 -3.6 742 (800-3.6)	840 -3.6 832 (900-3.6)

ILS or LOC RWY 26R

57°05.57'N
 009°50.95'E

AALBORG (EKYT)

CHANGES: NEW AALBORG HOSPITALSBYEN HELMS (PRIVATE HELIPAD) ADDED.

AIR COMMAND DENMARK - MIL-AIM 30 OCT 2025

MIPS

INSTRUMENT APPROACH CHART

AD ELEV 8

**HPMA VORTAC RWY 26R
AALBORG (EKYT)**

COPENHAGEN CONTROL 242.650 124.555		AALBORG ATIS 120.480		AALBORG APPROACH 362.450 123.980		AALBORG TOWER 353.525 118.305	
VORTAC AAL 116.70/CH 114x	APP COURSE 259°	FAF ALT 2000 FT	DESCENT GR. 5.24% (318 FT/NM)		MDA 420	THR 8	ALS LENGTH 900 M
LDA 8694 FT							

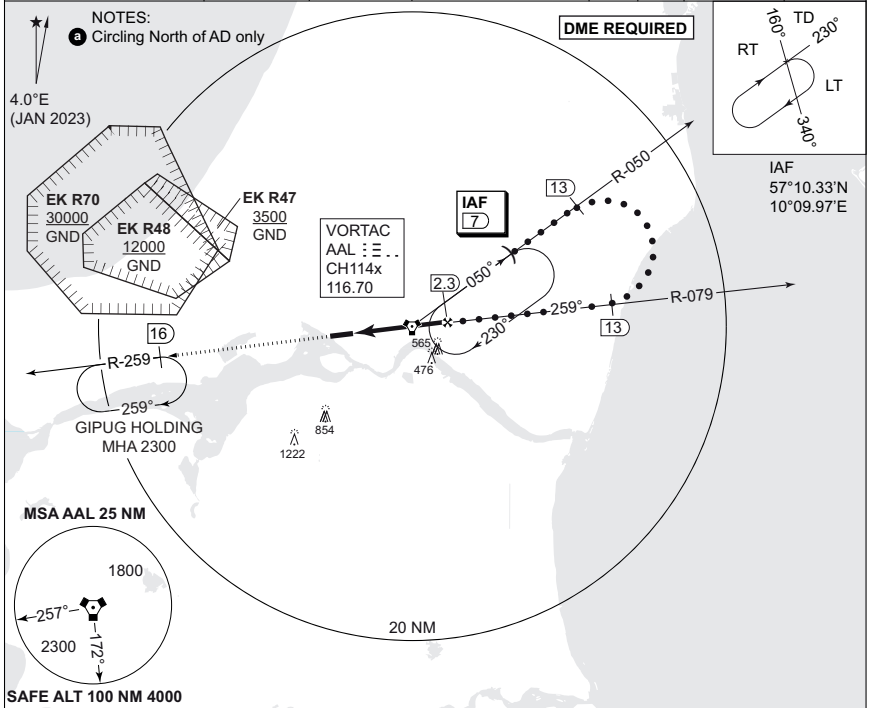

CDFA: 3.00° / 5.24%

DME AAL	2	1	0	1	2
DIST THR	1.8	2.8	3.8	4.8	5.8
ALT	640	960	1280	1600	1920

MISSED APPROACH
 Climb on AAL R-259 to
 DME 16. Join GIPUG
 holding at 2300 FT.

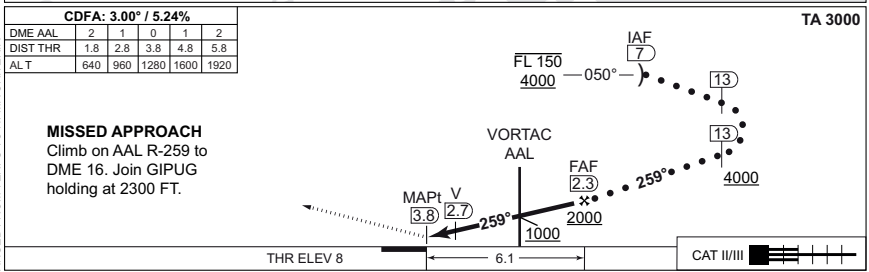

CATEGORY	HPMA
S-VORTAC 26R	420 - 1200 412 (500-1.2/1.9)
CIRCLING a	560 - 3.2 552 (600-3.2)

HPMA VORTAC RWY 26R

57°05.57'N
 009°50.95'E

AALBORG (EKYT)

CHANGES: PROCEDURE CHANGED FROM TERPS TO HPMA CRITERIA

AIR COMMAND DENMARK - MIL-AIM 03 OCT 2024

MIPS

INSTRUMENT APPROACH CHART

AD ELEV 8

**VORTAC RWY 26R
AALBORG (EKYT)**

COPENHAGEN CONTROL 242.650 124.555		AALBORG ATIS 120.480		AALBORG APPROACH 362.450 123.980		AALBORG TOWER 353.525 118.305	
VORTAC AAL 116.70/CH 114x	APP COURSE 259°	FAF ALT 2000 FT	DESCENT GR. 3.0° (5.24%)	MDA 420	THR ELEV 8	ALS LENGTH 900 M	LDA 8694 FT

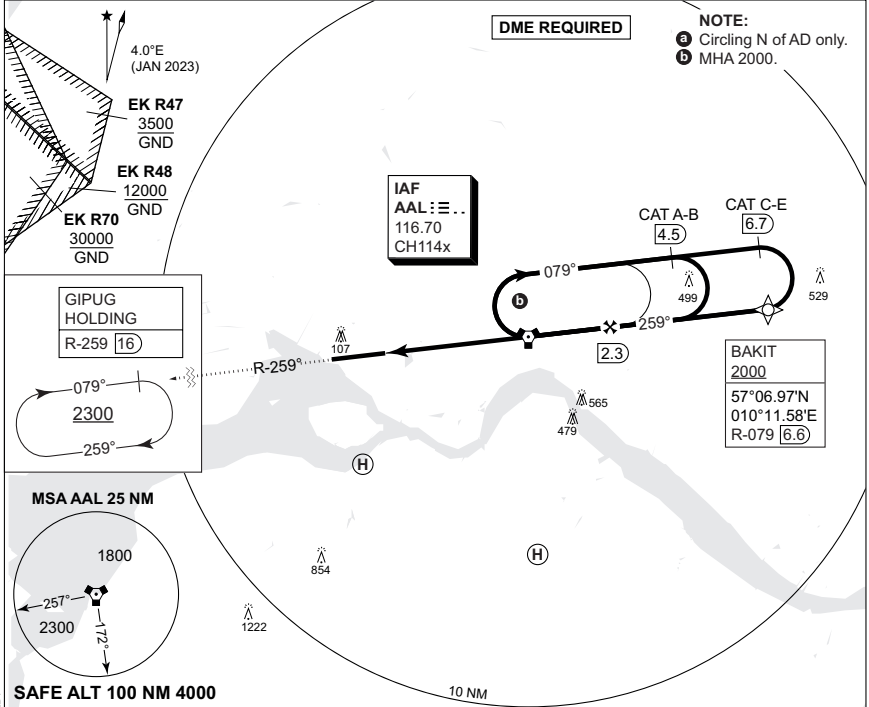

CDFA: 3.00° / 5.24%

DME AAL	2	1	0	1	2
DIST THR	1.8	2.8	3.8	4.8	5.8
ALT	640	960	1280	1600	1920

TA 3000

MISSED APPROACH:
Climb on AAL R-259 to DME 16. Join GIPUG holding at 2300 FT.

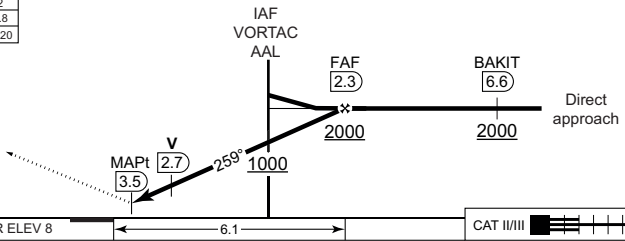

CATEGORY	A	B	C	D	E
VORTAC 26R	420 - 1200 412 (500-1.2/1.9)				
CIRCLING a	510 -1.5 502 (600-1.5)	510 -1.6 502 (600-1.6)	690 -2.4 682 (700-2.4)	750 -3.6 742 (800-3.6)	840 -3.6 832 (900-3.6)

VORTAC RWY 26R

57°05.57'N
009°50.95'E

AALBORG (EKYT)

CHANGES: NEW AALBORG HOSPITALSBYEN HELMS (PRIVATE HELIPAD) ADDED.

MIPS

AIR COMMAND DENMARK - MIL-AIM 30 OCT 2025

MIPS

INSTRUMENT APPROACH CHART

AD ELEV 8

RNP RWY 26R

AALBORG (EKY)

COPENHAGEN CONTROL 242.650 124.555		AALBORG ATIS 120.480		AALBORG APPROACH 362.450 123.980		AALBORG TOWER 353.525 118.305	
EGNOS CHANNEL 95396 / E26A	APP COURSE 259°	FAF ALT 2000 FT	DESCENT GR 3.00% (5.24%)	DA See CAT	THR ELEV 8	ALS LENGTH 900 M	LDA 8694 FT

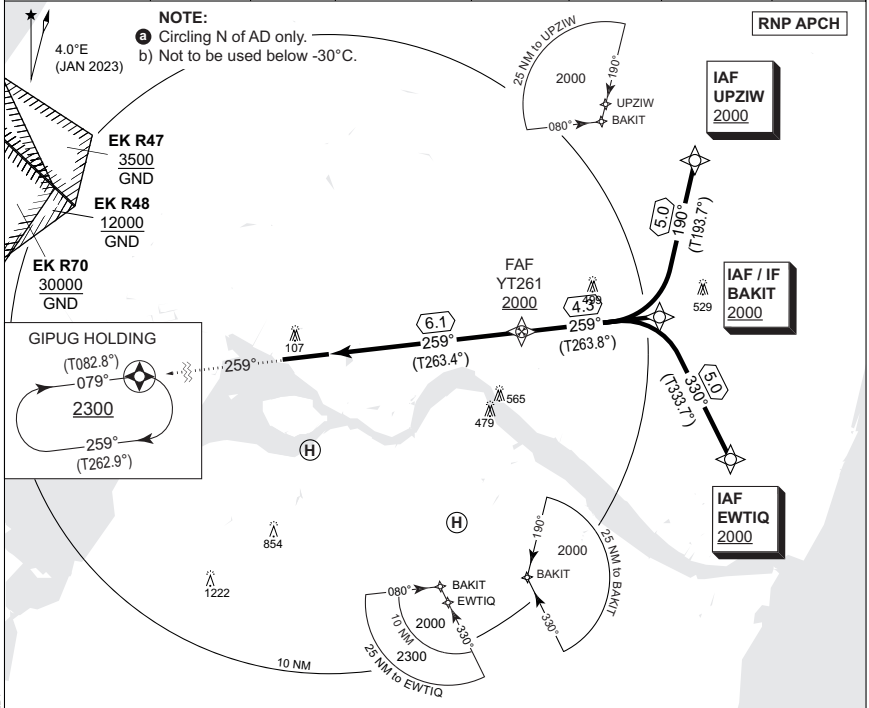

CDFA: 3.00% / 5.24%						TA 3000
DIST THR	2	3	4	5	6	GS 3.00°
ALT	700	1020	1330	1650	1970	RDH 51

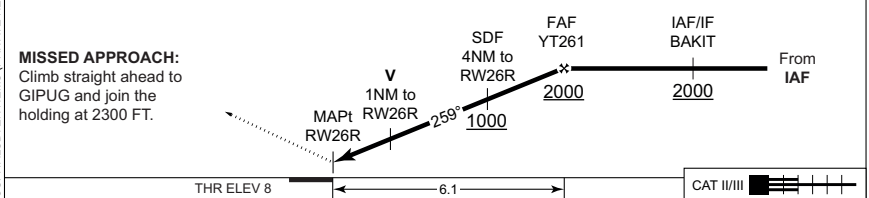

CATEGORY	A	B	C	D	E
LPV	258 - 600 250 (300-0.8/1.3)				
LNAV/VNAV	258 - 600 250 (300-0.8/1.3)	268 - 600 260 (300-0.8/1.3)	278 - 600 270 (300-0.8/1.3)	288 - 600 280 (300-0.8/1.3)	
LNAV	420 - 1200 412 (500-1.2/1.9)				
CIRCLING a	510 - 1.5 502 (600-1.5)	510 - 1.6 502 (600-1.6)	690 - 2.4 682 (700-2.4)	750 - 3.6 742 (800-3.6)	840 - 3.6 832 (900-3.6)

RNP RWY 26R

57°05.57'N
009°50.95'E

AALBORG (EKY)

CHANGES: NEW AALBORG HOSPITALSBYEN HELMS (PRIVATE HELIPAD) ADDED.

AIR COMMAND DENMARK - MIL.AIM.30 OCT 2025

EKYT RNP RWY 26R waypoint coordinates:

RWY 26R from EWTIQ (Initial LEFT) APPROACH RNP

		CODING			DISPLAY	
EWTIQ	IAF	57 02 29.73N	010 15 38.92E	57 02.496N	010 15.649E	
BAKIT	IF	57 06 58.00N	010 11 35.00E	57 06.967N	010 11.583E	
YT261	FAF	57 06 29.64N	010 03 42.31E	57 06.494N	010 03.705E	
RW26R	MAPt	57 05 47.43N	009 52 36.63E	57 05.790N	009 52.611E	
GIPUG	MAHF	57 04 20.00N	009 30 27.00E	57 04.333N	009 30.450E	

RWY 26R from UPZIW (Initial RIGHT) APPROACH RNP

		CODING			DISPLAY	
UPZIW	IAF	57 11 48.90N	010 13 44.95E	57 11.815N	010 13.749E	
BAKIT	IF	57 06 58.00N	010 11 35.00E	57 06.967N	010 11.583E	
YT261	FAF	57 06 29.64N	010 03 42.31E	57 06.494N	010 03.705E	
RW26R	MAPt	57 05 47.43N	009 52 36.63E	57 05.790N	009 52.611E	
GIPUG	MAHF	57 04 20.00N	009 30 27.00E	57 04.333N	009 30.450E	

Threshold coordinates RWY 26R

		CODING			DISPLAY	
RWY 26R		57 05 47.43N	009 52 36.63E	57 05.790N	009 52.611E	

AERODROME CHART

AARHUS (EKAH)

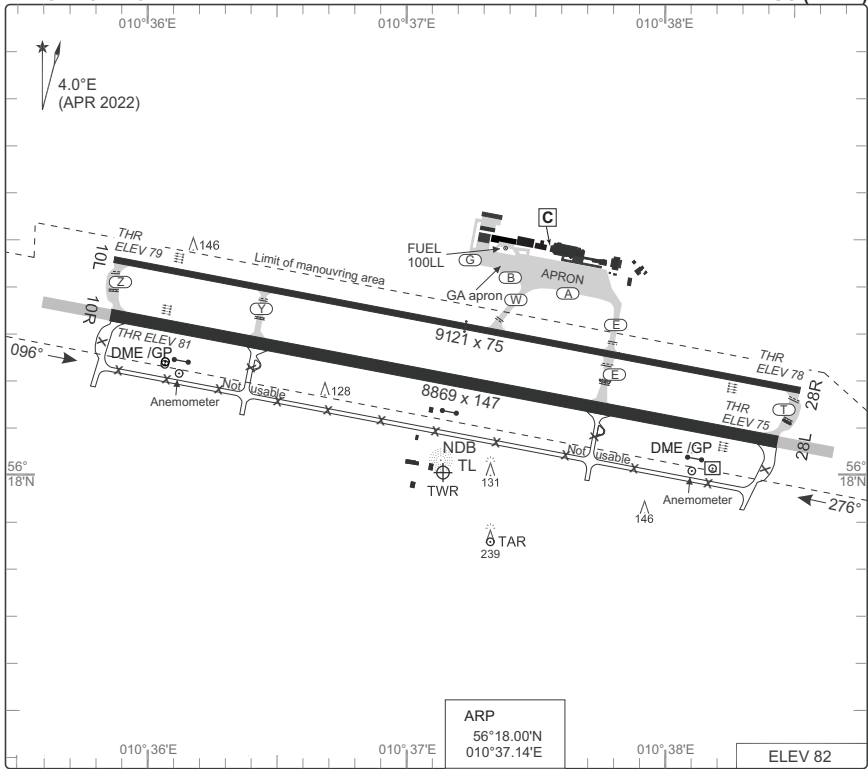

ARP
56°18.00'N
010°37.14'E

ELEV 82

RWY	PCN	TORA	TODA	ASDA	LDA	PAPI	THR ELEV	THR PSN
10R	76/R/B/X/U	8869	9597	9597	8869	2.75°	81	56°18.33'N 010°35.86'E
28L	76/R/B/X/U	8869	9807	9807	8869	2.75°	75	56°18.07'N 010°38.43'E
10L	120/F/B/W/T	9121	9121	9121	9121	3.00°	79	56°18.45'N 010°35.87'E
28R	120/F/B/W/T	9121	9121	9121	9121	3.00°	78	56°18.18'N 010°38.52'E

AARHUS TWR: 118.530 ATIS: 125.155
AARHUS HANDLING / AIRPORT OFFICE: 131.555

	PROC. CRITERIA	RWY	GS	TCH	OTCH	RPI	CAT	MINIMA CRITERIA	MINIMA
PAR	INTENTIONALLY LEFT BLANK								
SRA	INTENTIONALLY LEFT BLANK								

CHANGES: ATIS FREQ. CHG.

AIR COMMAND DENMARK - MIL_AIM_03 OCT 2024

AERODROME CHART

AARHUS (EKAH)

MIPS
INSTRUMENT APPROACH CHART

AD ELEV 82

RNP RWY 10R
AARHUS (EKAH)

COPENHAGEN CONTROL 313.425 123.725		AARHUS ATIS 125.155		AARHUS APPROACH 119.280		AARHUS TOWER 118.530	
EGNOS CHANNEL 45346 / E10A	APP COURSE 096°	FAF ALT 2000 FT	DESCENT GR 3.0° (5.24%)	MINIMA See CAT	THR ELEV 81	ALS 900 M	LDA 8869 FT

NOTE:

- a) PAPI 2.75° - not aligned with instrument procedure vertical path.
- b) Not to be used below -25°C.
- c) Max. 230 KIAS.

RNP APCH

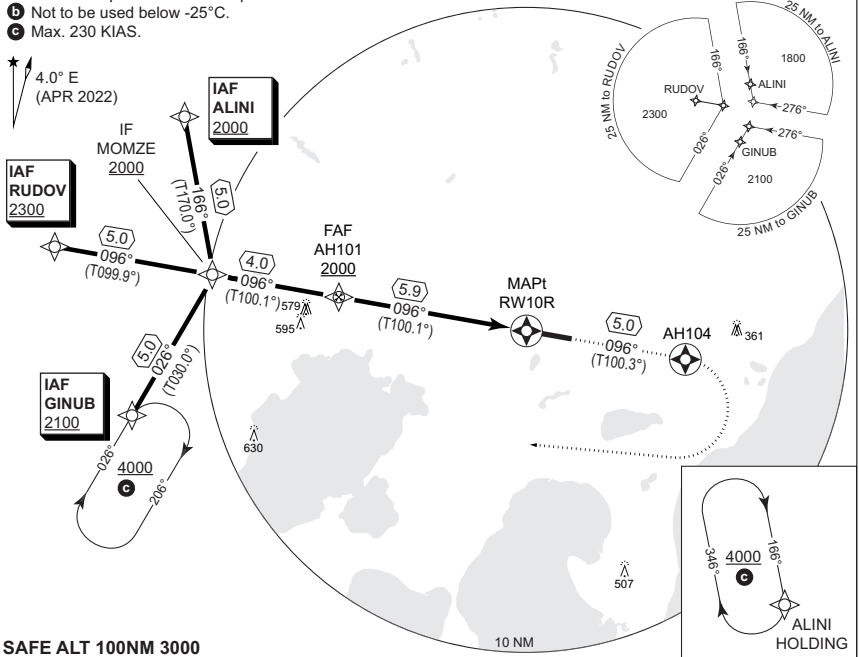

SAFE ALT 100NM 3000

TA 3000
GS 3.0°
RDH 50

CDFA: 3.00° / 5.24%

	5	4	3	2	1
DIST RW10R	1720	1410	1090	770	450
ALT					

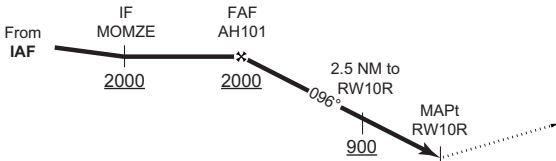

MISSED APPROACH

Climb on track to overfly AH104.
Turn right direct to GINUB and hold at 4000 ft.

CAT I: [Bar chart showing CAT I with a 5.9% descent gradient] THR ELEV 81

CATEGORY	A	B	C	D	E
LPV	331 - 600 250 (300-0.8/1.3)				
LNAV/VNAV b	360 - 600 278 (300-0.8/1.3)	380 - 650 298 (300-0.8/1.4)	380 - 650 298 (300-0.8/1.4)	400 - 700 318 (400-0.8/1.4)	420 - 800 338 (400-0.8/1.5)
LNAV	480 - 1100 398 (400-1.1/1.8)				
CIRCLING	570 - 1.5 488 (500-1.5)	680 - 1.6 598 (600-1.6)	1060 - 2.4 978 (1000-2.4)	1180 - 3.6 1098 (1100-3.6)	1180 - 3.6 1098 (1100-3.6)

RNP RWY 10R

56°18.00'N
010°37.14'E

AARHUS (EKAH)

CHANGES: ATIS FREQ. CHG.

AIR COMMAND DENMARK - MIL AIM 03 OCT 2024

EKAH RNP RWY 10R waypoint coordinates:

RWY 10R from ALINI APPROACH RNP

		CODING				DISPLAY	
ALINI	IAF	56 24 59.67N	010 16 54.33E	56 24.995°N	010 16.906°E		
MOMZE	IF	56 20 03.54N	010 18 28.24E	56 20.059°N	010 18.471°E		
AH101	FAF	56 19 21.87N	010 25 28.86E	56 19.365°N	010 25.481°E		
RW10R	MAPt	56 18 19.77N	010 35 51.24E	56 18.329°N	010 35.854°E		
AH104	MATF	56 17 26.08N	010 44 40.96E	56 17.435°N	010 44.683°E		
GINUB	MAHF	56 15 43.14N	010 13 57.87E	56 15.719°N	010 13.965°E		

RWY 10R from RUDOV APPROACH RNP

		CODING				DISPLAY	
RUDOV	IAF	56 20 55.59N	010 09 35.03E	56 20.927°N	010 09.584°E		
MOMZE	IF	56 20 03.54N	010 18 28.24E	56 20.059°N	010 18.471°E		
AH101	FAF	56 19 21.87N	010 25 28.86E	56 19.365°N	010 25.481°E		
RW10R	MAPt	56 18 19.77N	010 35 51.24E	56 18.329°N	010 35.854°E		
AH104	MATF	56 17 26.08N	010 44 40.96E	56 17.435°N	010 44.683°E		
GINUB	MAHF	56 15 43.14N	010 13 57.87E	56 15.719°N	010 13.965°E		

RWY 10R from GINUB APPROACH RNP

		CODING				DISPLAY	
GINUB	IAF	56 15 43.14N	010 13 57.87E	56 15.719°N	010 13.965°E		
MOMZE	IF	56 20 03.54N	010 18 28.24E	56 20.059°N	010 18.471°E		
AH101	FAF	56 19 21.87N	010 25 28.86E	56 19.365°N	010 25.481°E		
RW10R	MAPt	56 18 19.77N	010 35 51.24E	56 18.329°N	010 35.854°E		
AH104	MATF	56 17 26.08N	010 44 40.96E	56 17.435°N	010 44.683°E		
GINUB	MAHF	56 15 43.14N	010 13 57.87E	56 15.719°N	010 13.965°E		

Threshold coordinates RWY 10R

		CODING				DISPLAY	
RWY 10R		56 18 19.77N	010 35 51.24E	56 18.329°N	010 35.854°E		

MIPS INSTRUMENT APPROACH CHART

AD ELEV 82

**ILS or LOC RWY 10R
AARHUS (EKAH)**

COPENHAGEN CONTROL 313.425 123.725		AARHUS ATIS 125.155		AARHUS APPROACH 119.280			AARHUS TOWER 118.530	
LOC/DME AAR 111.900/CH 56x	APP COURSE 096°	GS INTCP ALT 2000 FT	GS 2.75°	DA See CAT	THR ELEV 81	ALS 900 M	LDA 8869 FT	

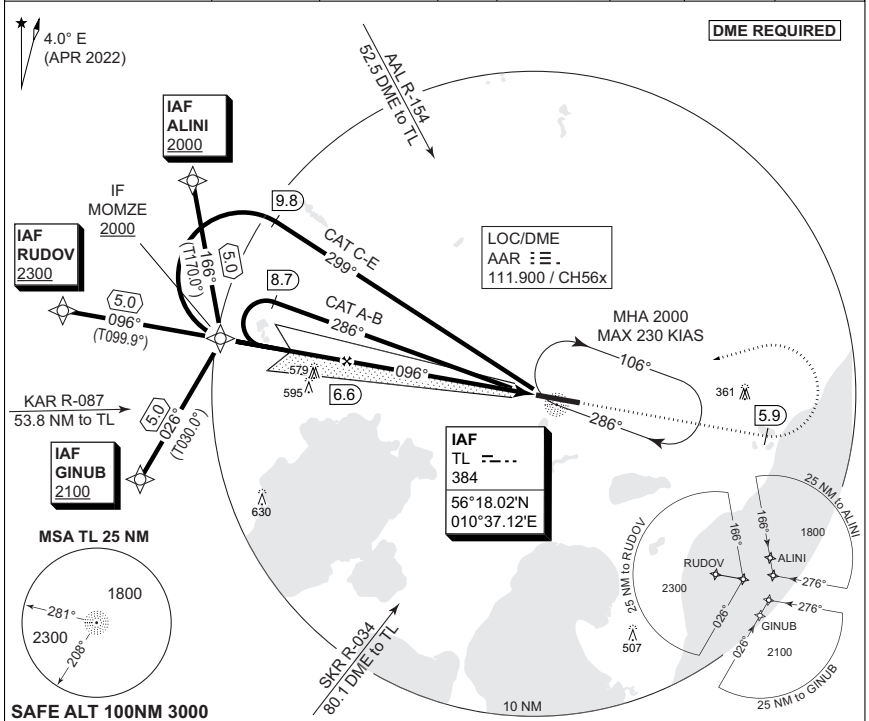

SAFE ALT 100NM 3000

TA 3000	GS 2.75°	RDH 34	IF MOMZE 2000	FAF 6.6	MAPt 0.5	850	096°	2.6	2000	2000	9.7	From IAF
---------	----------	--------	---------------	---------	----------	-----	------	-----	------	------	-----	----------

CDFA: 2.75° / 4.8%					
DME AAR	6	5	4	3	2
DIST THR	5.9	4.9	3.9	2.9	1.9
ALT	1840	1550	1260	960	670

MISSED APPROACH
Climb on track 096° to 2000 FT.
At DME AAR 5.9 turn left inbound NDB TL and hold.

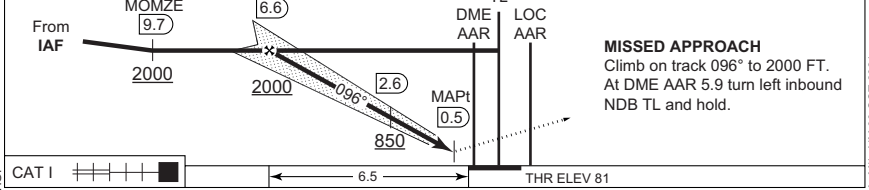

MIPS	CATEGORY	A	B	C	D	E
	S-ILS 10R	281 - 550 200 (200-0.8/1.2)				
	S-LOC 10R	480 - 1100 398 (400-1.1/1.8)				
	CIRCLING	570 - 1.5 488 (500-1.5)	680 - 1.6 598 (600-1.6)	1060 - 2.4 978 (1000-2.4)	1180 - 3.6 1098 (1100-3.6)	1180 - 3.6 1098 (1100-3.6)

ILS or LOC RWY 10R

56°18.00'N
010°37.14'E

AARHUS (EKAH)

CHANGES: ATIS FREQ. CHG.

AIR COMMAND DENMARK - MIL AIM 03 OCT 2024

MIPS
INSTRUMENT APPROACH CHART

AD ELEV 82

NDB RWY 10R
AARHUS (EKAH)

COPENHAGEN CONTROL 313.425 123.725		AARHUS ATIS 125.155		AARHUS APPROACH 119.280		AARHUS TOWER 118.530		
NDB TL 384	DME AAR CH 56x	APP COURSE 103°	FAF ALT 2000 FT	DESCENT GR 3.0° (5.24%)	MDA 590	THR ELEV 81	ALS 900 M	LDA 8869 FT

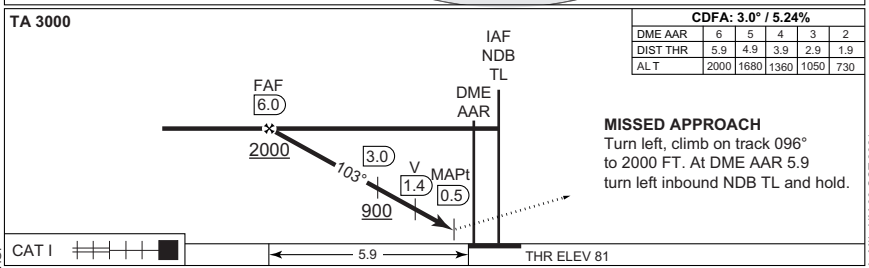
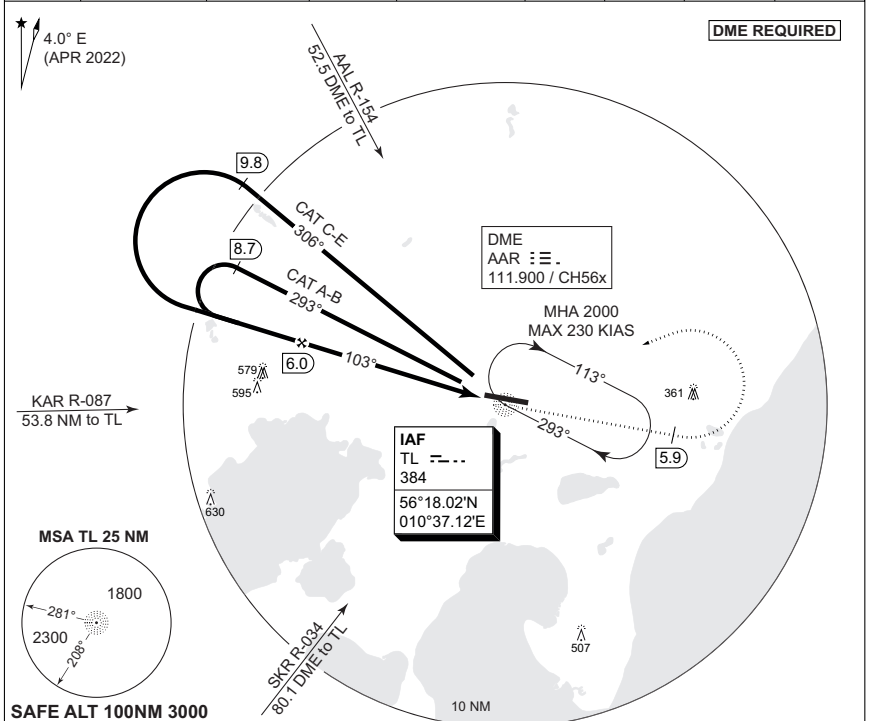

CATEGORY	A	B	C	D	E
S-NDB 10R	590 - 1600 508 (600-1.6/2.4)				
CIRCLING	590 - 1.6 508 (600-1.6)	680 - 1.6 598 (600-1.6)	1060 - 2.4 978 (1000-2.4)	1180 - 3.6 1098 (1100-3.6)	1180 - 3.6 1098 (1100-3.6)

NDB RWY 10R

56°18.00'N
010°37.14'E

AARHUS (EKAH)

CHANGES: ATIS FREQ. CHG.

AIR COMMAND DENMARK - MIL AIM 03 OCT 2024

MIPS

INSTRUMENT APPROACH CHART

AD ELEV 82

RNP RWY 28L
AARHUS (EKAH)

COPENHAGEN CONTROL 313.425 123.725		AARHUS ATIS 125.155		AARHUS APPROACH 119.280		AARHUS TOWER 118.530	
EGNOS CHANNEL 48468 / E28A	APP COURSE 277°	FAF 2000 FT	DESCENT GR 3.0% (5.24%)	MINIMA See CAT	THR ELEV 75	ALS 900 M	LDA 8869 FT

NOTE:

- a) PAPI 2.75° - not aligned with instrument procedure vertical path.
 b) Not to be used below -25°C.
 c) Max. 230 KIAS.

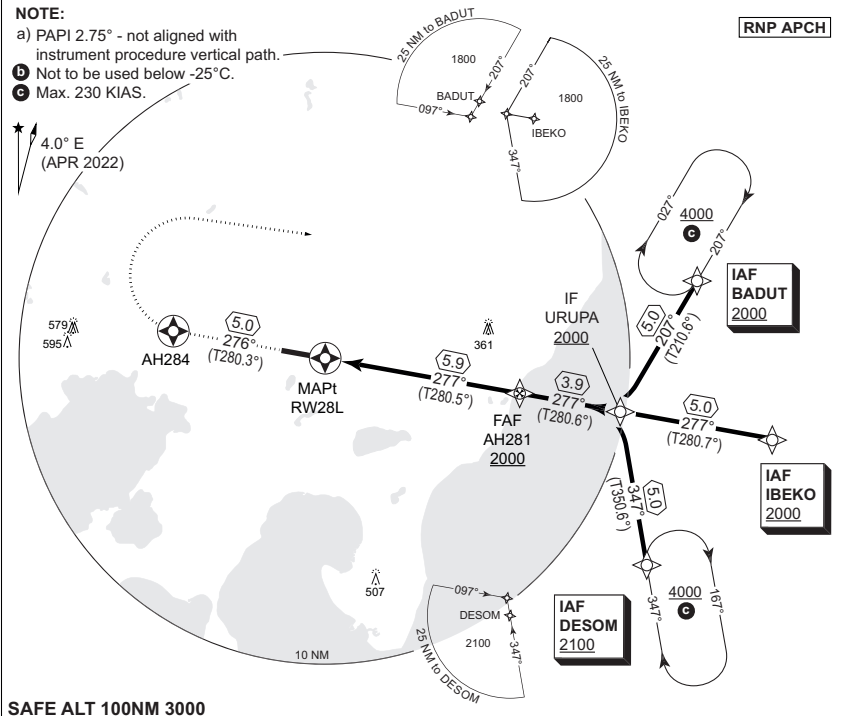

SAFE ALT 100NM 3000

CDFA: 3.0° / 5.24%					
DIST RW28L	1	2	3	4	5
ALT	450	770	1080	1400	1720

TA 3000
GS 3.0°
TCH 50

MISSED APPROACH

Climb on track 276° to overfly AH284. Turn right direct to BADUT and hold at 4000 FT.

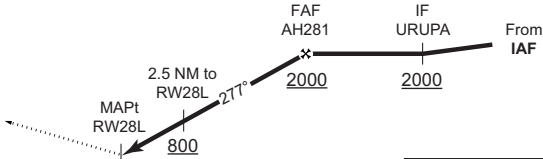

THR ELEV 75

5.9

CAT II

CATEGORY	A	B	C	D	E
LPV	325 - 600 250 (300-0.8/1.3)				
LNAV/VNAV b	360 - 600 278 (300-0.8/1.3)	380 - 650 298 (300-0.8/1.4)	390 - 700 308 (400-0.8/1.4)	400 - 700 318 (400-0.8/1.4)	420 - 800 338 (400-0.8/1.5)
LNAV	480 - 1100 398 (400-1.1/1.8)				
CIRCLING	570 - 1.5 488 (500-1.5)	680 - 1.6 598 (600-1.6)	1060 - 2.4 978 (1000-2.4)	1180 - 3.6 1098 (1100-3.6)	1180 - 3.6 1098 (1100-3.6)

RNP RWY 28L

56°18.00'N
010°37.14'E

AARHUS (EKAH)

EKAH RNP RWY 28L waypoint coordinates:**RWY 28L from DESOM APPROACH RNP**

		CODING			DISPLAY
DESOM	IAF	56 11 20.95N	010 57 15.54E	56 11.349°N 010 57.259°E	
URUPA	IF	56 16 17.56N	010 55 47.00E	56 16.293°N 010 55.783°E	
AH281	FAF	56 17 00.62N	010 48 49.58E	56 17.010°N 010 48.826°E	
RW28L	MAPt	56 18 04.17N	010 38 25.84E	56 18.069°N 010 38.431°E	
AH284	MATF	56 18 57.42N	010 29 35.84E	56 18.957°N 010 29.597°E	
BADUT	MAHF	56 20 36.42N	011 00 22.19E	56 20.607°N 011 00.370°E	

RWY 28L from IBEKO APPROACH RNP

		CODING			DISPLAY
IBEKO	IAF	56 15 22.19N	011 04 38.05E	56 15.370°N 011 04.634°E	
URUPA	IF	56 16 17.56N	010 55 47.00E	56 16.293°N 010 55.783°E	
AH281	FAF	56 17 00.62N	010 48 49.58E	56 17.010°N 010 48.826°E	
RW28L	MAPt	56 18 04.17N	010 38 25.84E	56 18.069°N 010 38.431°E	
AH284	MATF	56 18 57.42N	010 29 35.84E	56 18.957°N 010 29.597°E	
BADUT	MAHF	56 20 36.42N	011 00 22.19E	56 20.607°N 011 00.370°E	

RWY 28L from BADUT APPROACH RNP

		CODING			DISPLAY
BADUT	IAF	56 20 36.42N	011 00 22.19E	56 20.607°N 011 00.370°E	
URUPA	IF	56 16 17.56N	010 55 47.00E	56 16.293°N 010 55.783°E	
AH281	FAF	56 17 00.62N	010 48 49.58E	56 17.010°N 010 48.826°E	
RW28L	MAPt	56 18 04.17N	010 38 25.84E	56 18.069°N 010 38.431°E	
AH284	MATF	56 18 57.42N	010 29 35.84E	56 18.957°N 010 29.597°E	
BADUT	MAHF	56 20 36.42N	011 00 22.19E	56 20.607°N 011 00.370°E	

Threshold coordinates RWY 28L

		CODING			DISPLAY
RWY 28L		56 18 04.17N	010 38 25.84E	56 18.069°N 010 38.431°E	

MIPS

ILS or LOC RWY 28L (CAT A-B)

INSTRUMENT APPROACH CHART

AD ELEV 82

AARHUS (EKAH)

COPENHAGEN CONTROL 313.425 123.725		AARHUS ATIS 125.155		AARHUS APPROACH 119.280			AARHUS TOWER 118.530	
LOC/DME TR 111.100/CH 48x	APP COURSE 277°	GS INTCP ALT 2000 FT	GS 2.75°	DA 275	THR ELEV 75	ALS 900 M	LDA 8869 FT	

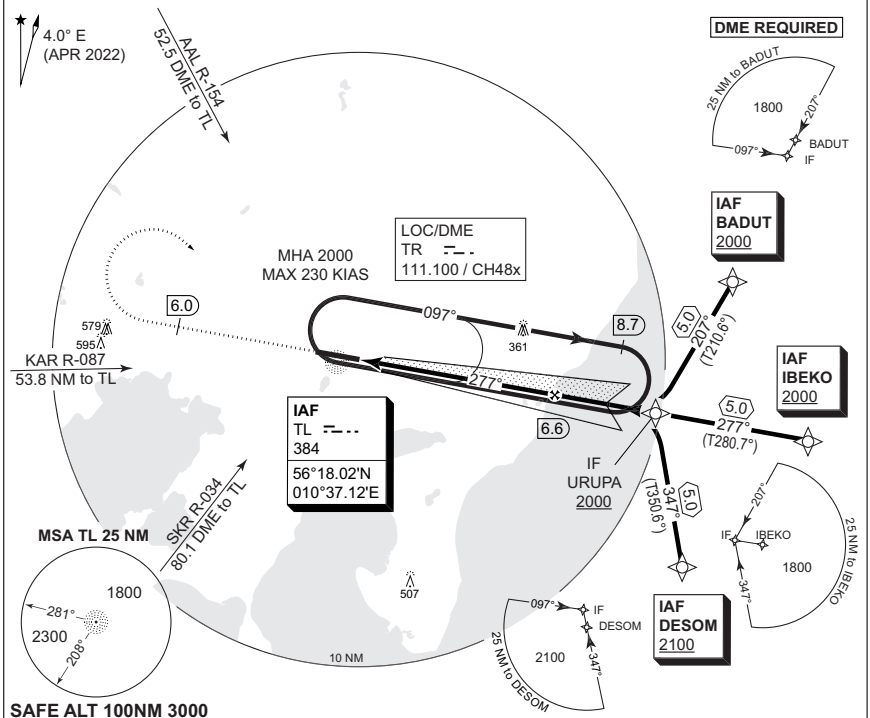

CDFA: 2.75° / 4.8%

DME AAR	2	3	4	5	6
DIST THR	1.9	2.9	3.9	4.9	5.9
ALT	670	960	1260	1550	1840

TA 3000
GS 2.75°
RDH 36

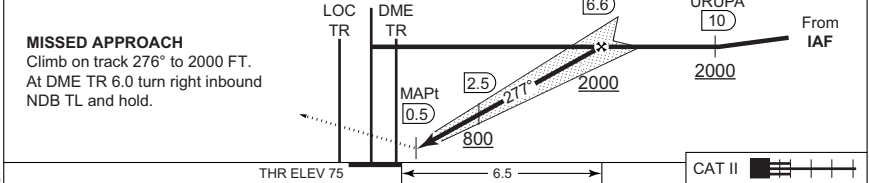

CATEGORY	A	B
S-ILS CAT I	275 - 550 200 (200-0.8/1.2)	
S-ILS CAT II	RA 99 (DA 175) - 350 100	
S-LOC 28L	480 - 1100 398 (400-1.1/1.8)	
CIRCLING	570 - 1.5 488 (500-1.5)	680 - 1.6 598 (600-1.6)

ILS or LOC RWY 28L (CAT A-B)

56°18.00'N
010°37.14'E

AARHUS (EKAH)

CHANGES: ATIS FREQ. CHG.

AIR COMMAND DENMARK - MIL-AIM 03 OCT 2024

MIPS

INSTRUMENT APPROACH CHART

AD ELEV 82

ILS or LOC RWY 28L (CAT C-E)

AARHUS (EKAH)

COPENHAGEN CONTROL 313.425 123.725		AARHUS ATIS 125.155		AARHUS APPROACH 119.280			AARHUS TOWER 118.530	
LOC/DME TR 111.100/CH 48x	APP COURSE 277°	GS INTCP ALT 2000 FT	GS 2.75°	DA 275	THR ELEV 75	ALS 900 M	LDA 8869 FT	

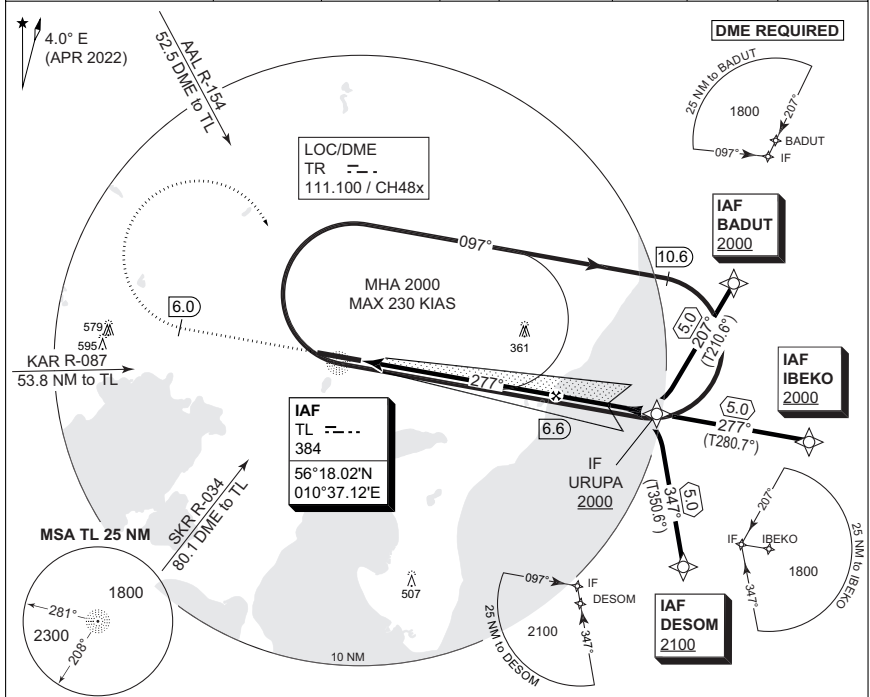

SAFE ALT 100NM 3000

CDFA: 2.75° / 4.8%						TA 3000 GS 2.75° RDH 36
DME AAR	2	3	4	5	6	
DIST THR	1.9	2.9	3.9	4.9	5.9	
ALT	670	960	1260	1550	1840	

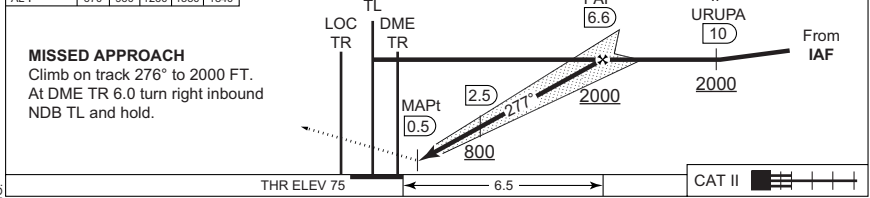

CATEGORY	C	D	E
S-ILS CAT I	275 - 550 200 (200-0.8/1.2)		
S-ILS CAT II	RA 99 (DA 175) - 350 100		N/A
S-LOC 28L	480 - 1100 398 (400-1.1/1.8)		
CIRCLING	1060 - 2.4 978 (1000-2.4)	1180 - 3.6 1098 (1100-3.6)	1180 - 3.6 1098(1100-3.6)

ILS or LOC RWY 28L (CAT C-E) 56°18.00'N
010°37.14'E AARHUS (EKAH)

CHANGES: ATIS FREQ. CHG.

AIR COMMAND DENMARK - MIL AIM 03 OCT 2024

MIPS

INSTRUMENT APPROACH CHART

AD ELEV 82

**NDB RWY 28L (CAT A-B)
AARHUS (EKAH)**

COPENHAGEN CONTROL 313.425 123.725		AARHUS ATIS 125.155		AARHUS APPROACH 119.280		AARHUS TOWER 118.530	
NDB TL 384	APP COURSE 270°	FAF ALT 2000 FT	DESCENT GR 3.0° (5.24%)	MDA 480	THR ELEV 75	ALS 900 M	LDA 8869 FT

NOTE:

a) No turn before MAPt.

DME REQUIRED

4.0° E
(APR 2022)

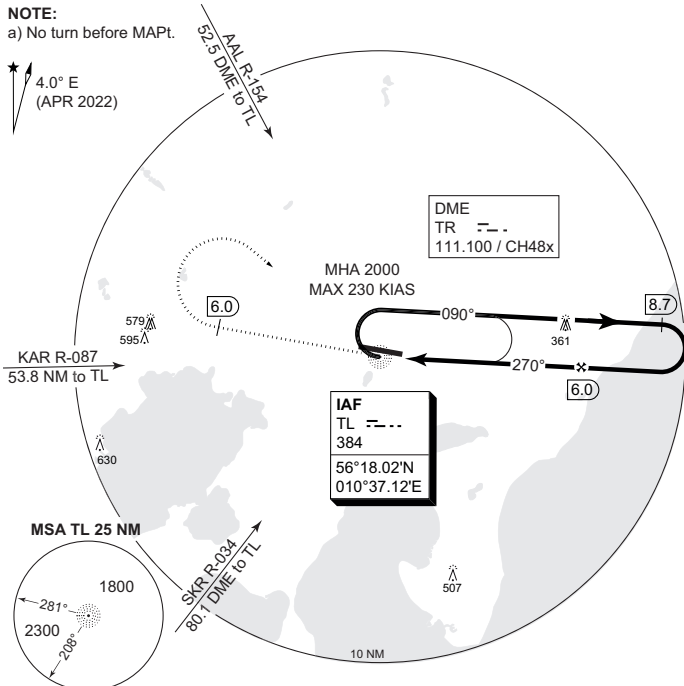

SAFE ALT 100NM 3000

CDFA: 3.0° / 5.24%

DME TR	2	3	4	5	6
DIST THR	1.9	2.9	3.9	4.9	5.9
ALT	720	1040	1360	1680	2000

TA 3000

MISSED APPROACH

Turn right, climb on track 277° to 2000 FT. At DME TR 6.0 turn right inbound NDB TL and hold.

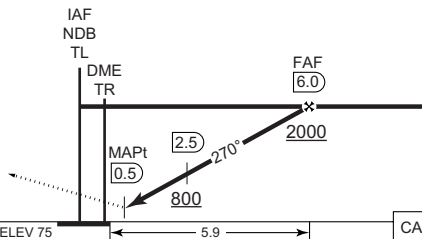

CAT II

CATEGORY	A		B	
S-NDB 28L	480 - 1100 398 (400-1.1/1.8)			
CIRCLING	570 - 1.5 488 (500-1.5)		680 - 1.6 598 (600-1.6)	

NDB RWY 28L (CAT A-B)

56°18.00'N
010°37.14'E

AARHUS (EKAH)

CHANGES: RWY ADDED TO PROCEDURE NAME IN LOWER LEFT CORNER

AIR COMMAND DENMARK - MIL_AIM_28_NOV_2024

MIPS

INSTRUMENT APPROACH CHART

AD ELEV 82

NDB RWY 28L (CAT C-E)

AARHUS (EKAH)

COPENHAGEN CONTROL 313.425 123.725		AARHUS ATIS 125.155		AARHUS APPROACH 119.280		AARHUS TOWER 118.530	
NDB TL 384	APP COURSE 270°	FAF ALT 2000 FT	DESCENT GR 3.0° (5.24%)	MDA See CAT	THR ELEV 75	ALS 900 M	LDA 8869 FT

NOTE:

a) No turn before MAPt.

DME REQUIRED

4.0° E
(APR 2022)

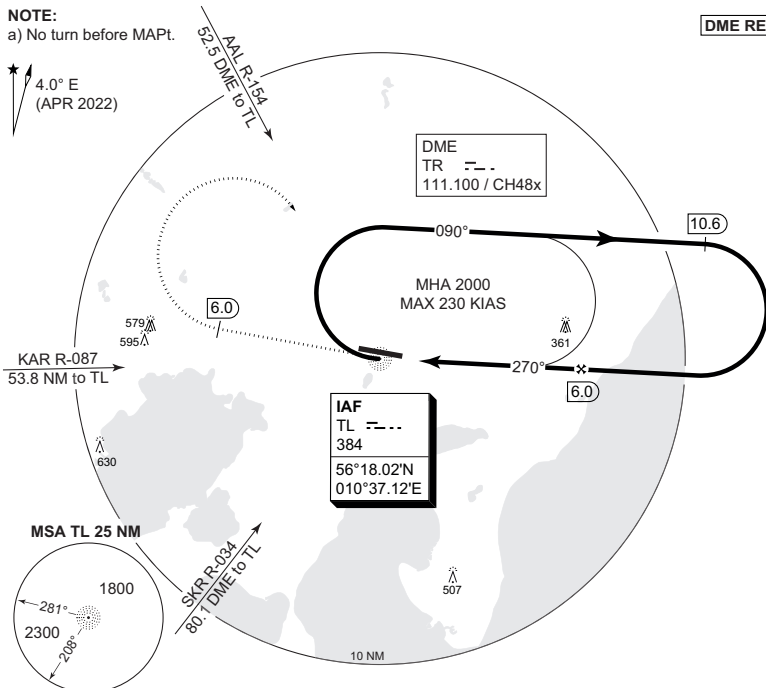

SAFE ALT 100NM 3000

CDFA: 3.0° / 5.24%

DME TR	2	3	4	5	6
DIST THR	1.9	2.9	3.9	4.9	5.9
ALT	720	1040	1360	1680	2000

TA 3000

MISSED APPROACH

Turn right, climb on track 277° to 2000 FT. At DME TR 6.0 turn right inbound NDB TL and hold.

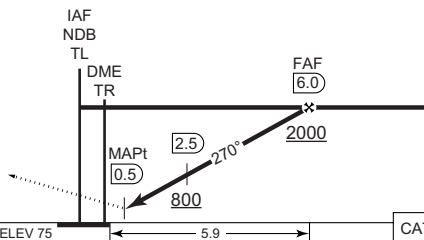

THR ELEV 75

5.9

CAT II

CATEGORY	C	D	E
S-NDB 28L	490 - 1200 415 (500-1.2/1.9)	510 - 1300 435 (500-1.3/2.0)	560 - 1500 485 (500-1.5/2.3)
CIRCLING	1060 - 2.4 978 (1000-2.4)	1180 - 3.6 1098 (1100-3.6)	1180 - 3.6 1098 (1100-3.6)

NDB RWY 28L (CAT C-E)

56°18.00'N
010°37.14'E

AARHUS (EKAH)

CHANGES: ATIS FREQ. CHG.

MIPS

AIR COMMAND DENMARK - MIL_AIM 03 OCT 2024

AERODROME CHART

ANDOEYA (ENAN)

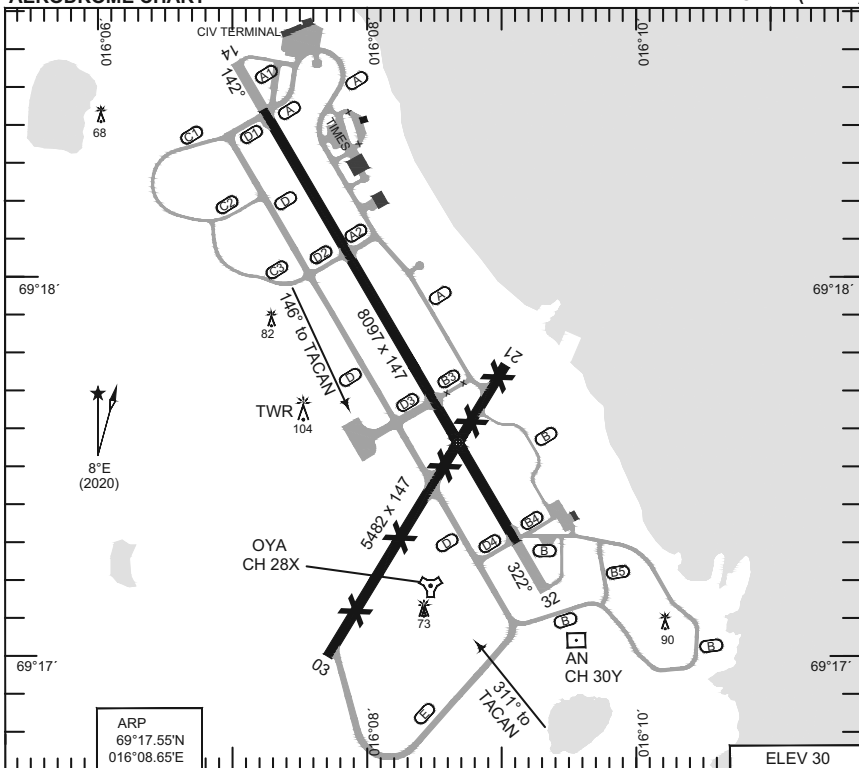

ARP
69°17.55'N
016°08.65'E

ELEV 30

RWY	PCN	TORA	ASDA	TODA	LDA	PAPI	THR ELEV	THR PSN	
14	60 F/A/W/T	8097	8097	8097	8097	3.0°	26	69°18.42'N	016°07.19'E
32	60 F/A/W/T	8097	8097	9081	8097	3.0°	17	69°17.28'N	016°09.08'E
03	RUNWAY CLOSED								
21	RUNWAY CLOSED								

ATIS 136.130
DE-ICE 121.950
ANDOEYA TWR / APPR 118.205 118.705 122.100 369.250 363.675 257.800

CHANGES: FREQUENCIES:

RNOAF 25 DEC 2025

AERODROME CHART

ANDOEYA (ENAN)

MIPS
INSTRUMENT APPROACH CHART

LOC M RWY 14
ANDOEYA (ENAN)

AD ELEV 30

ATIS 136.130	ANDOEYA TWR / APPR 118.205 118.705 122.100 369.250 363.675 257.800					ALS 900 m	LDA 8097
LOCALIZER / DME AN 109.350 / CH 30Y	APP COURSE 142°	FAF ALT 1500	Descent GR 5.1% (2.9°)	MDA 340	THR ELEV 26		

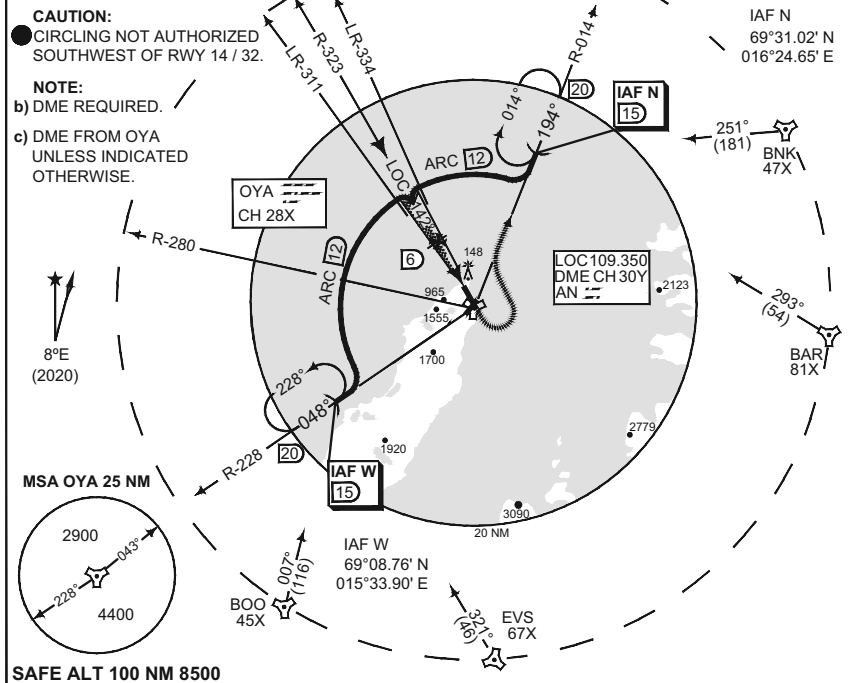

SAFE ALT 100 NM 8500

DME	6	5	4	3	
ALT OYA	1500	1200	890	590	
ALT AN	1410	1110	800	500	

TA 7000

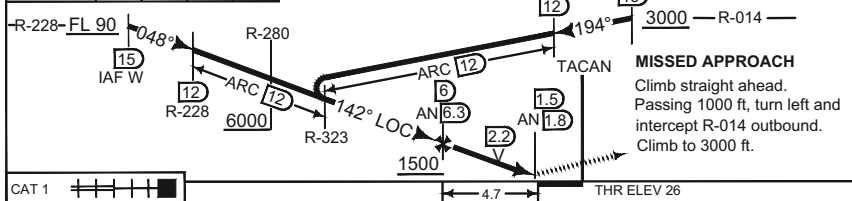

CAT 1 THR ELEV 26

CATEGORY	A	B	C	D	E
S-LOC 14	340 - 750 314 (400 - 0.8/1.4)				
● CIRCLING	450 - 1.5 420 (500 - 1.5)	530 - 1.6 500 (500 - 1.6)	630 - 2.4 600 (600 - 2.4)	730 - 3.6 700 (700 - 3.6)	830 - 3.6 800 (800 - 3.6)

LOC M RWY 14

69°17.55' N
016°08.65' E

ANDOEYA (ENAN)

CHANGES: FREQUENCIES MIPS

RNOCAF 25 DEC 2025

MIPS
INSTRUMENT APPROACH CHART

AD ELEV 30

TACAN RWY 14
ANDOEYA (ENAN)

ATIS 136.130	ANDOEYA TWR / APPR 118.205 118.705 122.100 369.250 363.675 257.800						
TACAN OYA 28X	APP COURSE 146°	FAF ALT 1500	Descent GR 5.1% (2.9°)	MDA 480	THR ELEV 26	ALS 900 m	LDA 8097

CAUTION:

● CIRCLING NOT AUTHORIZED
SOUTHWEST OF RWY 14 / 32.

NOTE:

b) FINAL OFFSET 4° NORTH.

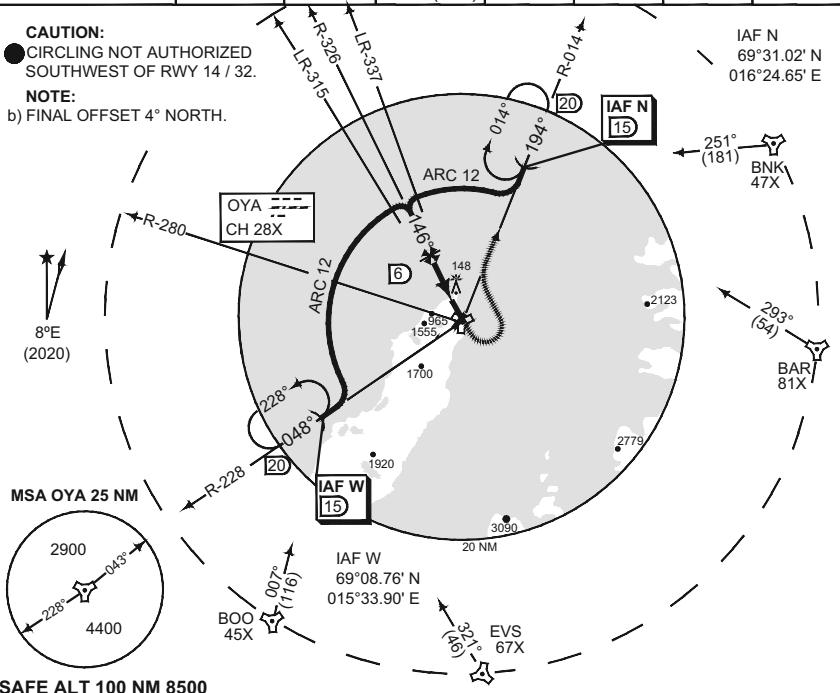

DME OYA	6	5	4	3	TA 7000
ALT	1500	1200	890	590	

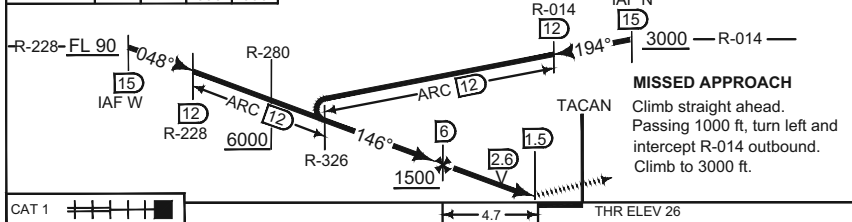

CATEGORY	A	B	C	D	E
S-TAC 14	480 - 1400 454 (500 - 1.4/2.1)				
● CIRCLING	450 - 1.5 420 (500 - 1.5)	530 - 1.6 500 (500 - 1.6)	630 - 2.4 600 (600 - 2.4)	730 - 3.6 700 (700 - 3.6)	830 - 3.6 800 (800 - 3.6)

TACAN RWY 14

69°17.55' N
016°08.65' E

ANDOEYA (ENAN)

CHANGES/FREQUENCIES
MIPS

RNOAF 25 DEC 2025

MIPS
INSTRUMENT APPROACH CHART

TACAN RWY 32
ANDOEYA (ENAN)

AD ELEV 30

ATIS 136.130	ANDOEYA TWR / APPR 118.205 118.705 122.100 369.250 363.675 257.800						
TACAN OYA CH 28X	APP COURSE 311°	FAF ALT 2000	Descent GR 5.4% (3.1°)	MDA SEE CAT	THR ELEV 17	ALS 900 m	LDA 8097

CAUTION:
● CIRCLING NOT AUTHORIZED
SOUTHWEST OF RWY 14 / 32.

NOTE:
b) FINAL OFFSET 11° EAST.

IAF N
69°31.02' N
016°24.65' E

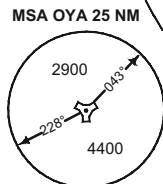
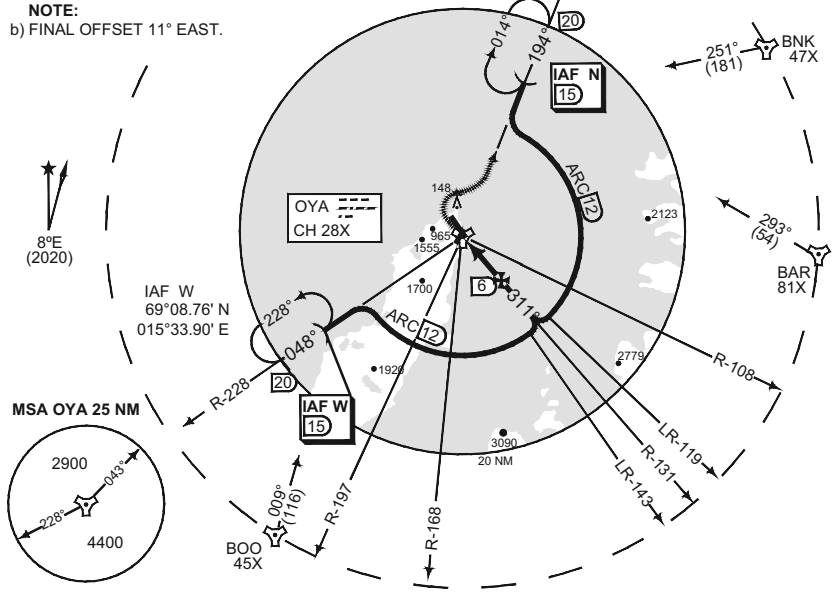

SAFE ALT 100 NM 8500

DME OYA	6	5	4	3	2	1
ALT	2000	1680	1360	1040	710	390

TA 7000

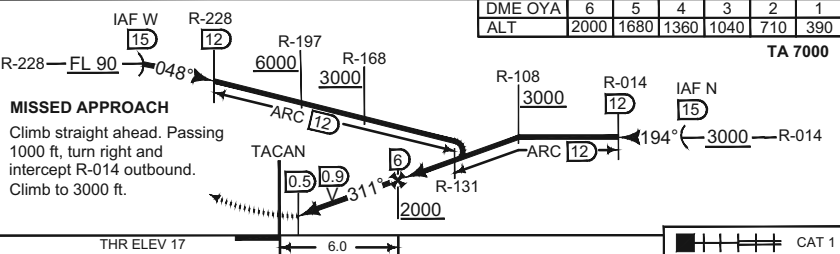

THR ELEV 17 6.0 CAT 1

CATEGORY	A	B	C	D	E
S-TAC 32	370 - 900 353 (400 - 0.9/1.6)	400 - 1100 383 (400 - 1.1/1.8)	430 - 1200 413 (500 - 1.2/1.9)	450 - 1300 433 (500 - 1.3/2.0)	500 - 1500 483 (500 - 1.5/2.3)
● CIRCLING	450 - 1.5 420 (500 - 1.5)	530 - 1.6 500 (500 - 1.6)	630 - 2.4 600 (600 - 2.4)	730 - 3.6 700 (700 - 3.6)	830 - 3.6 800 (800 - 3.6)

CHANGES: FREQUENCIES
MIPS

RNOAF 25 DEC 2025

TACAN RWY 32

69°17.55' N
016°08.65' E

ANDOEYA (ENAN)

**MIPS
AERODROME CHART**

ALTA(ENAT)

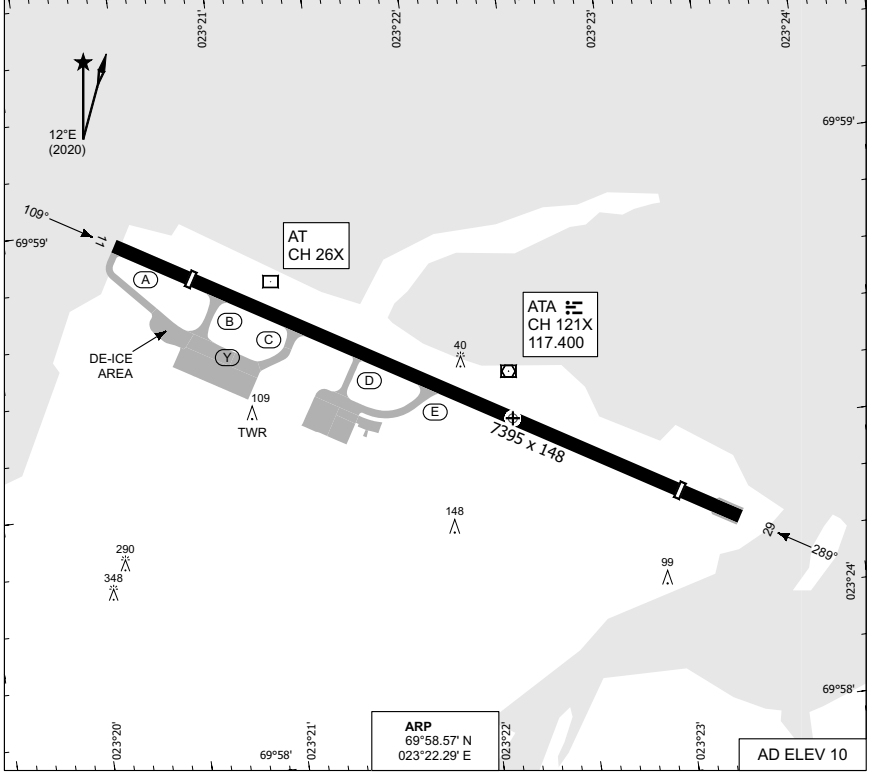

RWY	PCN	TORA	ASDA	TODA	LDA	PAPI	THR ELEV	THR PSN
11	50/F/B/X/U	6978	6978	7470	6073	3.7°	9	69°58.89' N - 023°20.74' E
29	50/F/B/X/U	6965	6965	7457	6257	4.2°	8	69°58.40' N - 023°23.10' E

ATIS 118.180
ALTA TWR 120.405

PROC. CRITERIA	RWY	GS	TCH	OTCH	RPI	CAT	MINIMA CRITERIA	MINIMA

CHANGE: PERIODIC REVIEW

RNOAF 30 OCT 2025

AERODROME CHART

ALTA(ENAT)

MIPS INSTRUMENT APPROACH CHART

HPMA ILS or LOC RWY 11 ALTA(ENAT)

AD ELEV 10

ATIS 118.180		ALTA TWR/APP 120.405					
LOC/DME AT 108.900/CH 26X	APP COURSE 109°	GS INTCP ALT 4000	GS 3.7°	DA 525	THR ELEV 9	ALS-LENGTH 288 m	LDA 6072

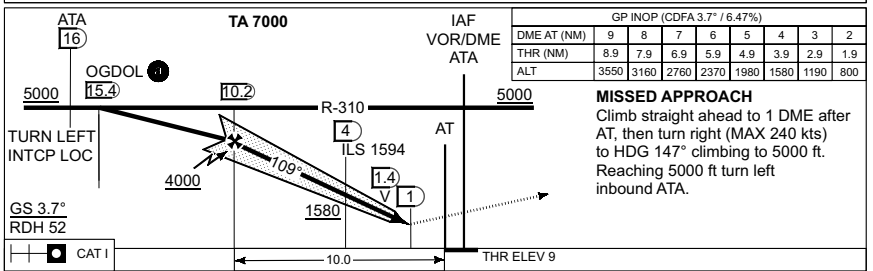
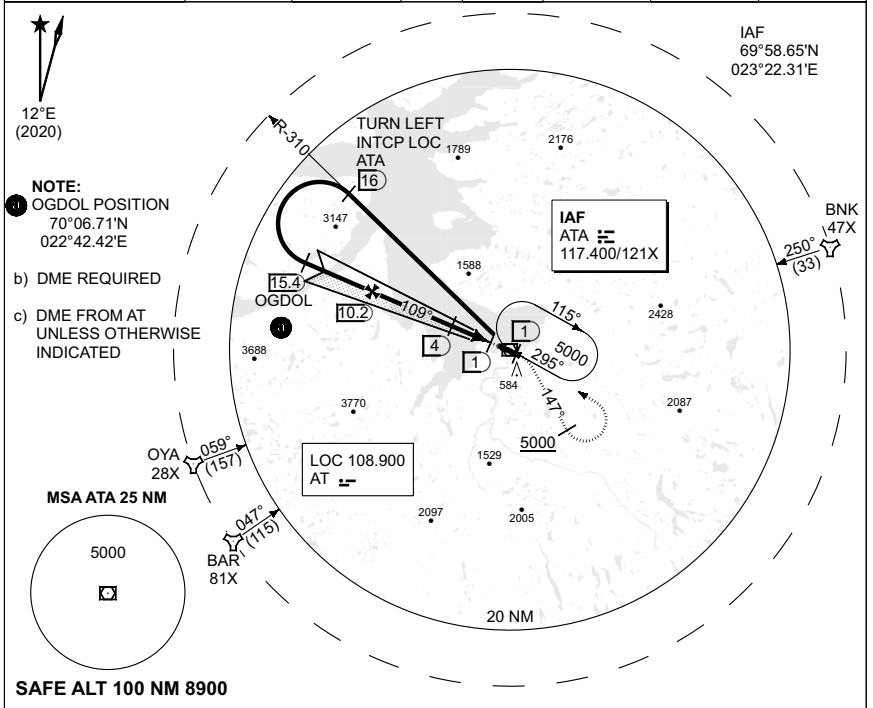

CATEGORY	HPMA
HPMA ILS 11	525 - 2.1 516 (600 - 2.1/2.4)
HPMA LOC 11	630 - 2.7 621 (700 - 2.7/2.9)
CIRCLING	NOT AUTHORIZED

HPMA ILS or LOC RWY 11

69°58.57' N
 023°22.29' E

ALTA(ENAT)

CHANGE: NEW CHART

RNO/AF 19 FEB 2026

AERODROME CHART

BANAK (ENNA)

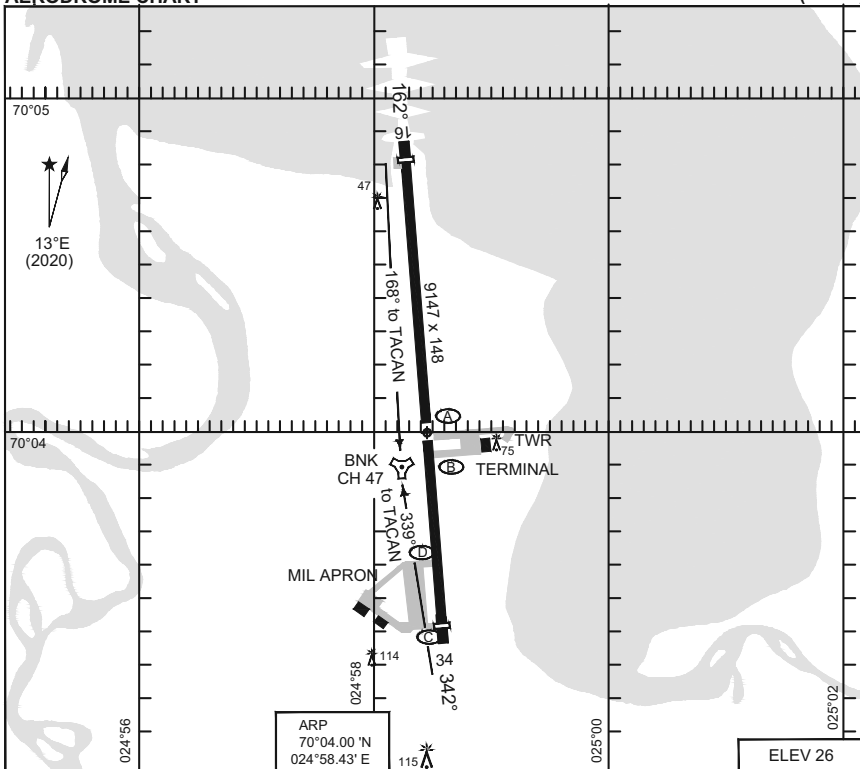

RWY	PCN	TORA	ASDA	TODA	LDA	PAPI	TDZE	THR PSN
16	70 F/A/W/U	9137	9137	9806	8838	3.0°	16	70°04.82' N - 024°58.25' E
34	70 F/A/W/U	8838	8838	13257	8543	3.5°	25	70°03.43' N - 024°58.57' E

ATIS 136.330
 DE-ICE 131.880
 BANAK TWR / APPR 118.905 118.055 257.800 280.350

CHANGES: FREQUENCIES.

RNOAF 25 DEC 2025

AERODROME CHART

BANAK (ENNA)

**MIPS
INSTRUMENT DEPARTURE CHART**

**TACAN SID RWY 16 / 34
BANAK (ENNA)**

AD ELEV 26

ATIS 136.330	BANAK TWR / APPR 118.905 118.055 257.800 280.350		POLARIS CONTROL 126.705								
RWY 16	MIN CLIMB 4.5%	2.6°	GS (kt) V/V (fpm)	60 280	120 550	180 820	240 1100	300 1400	360 1700	to 1400 ft	Reason TERRAIN

NOTE:

- a) FLUCTUATIONS MAY OCCUR BETWEEN BNK 13 DME AND 17 DME ON R-347.

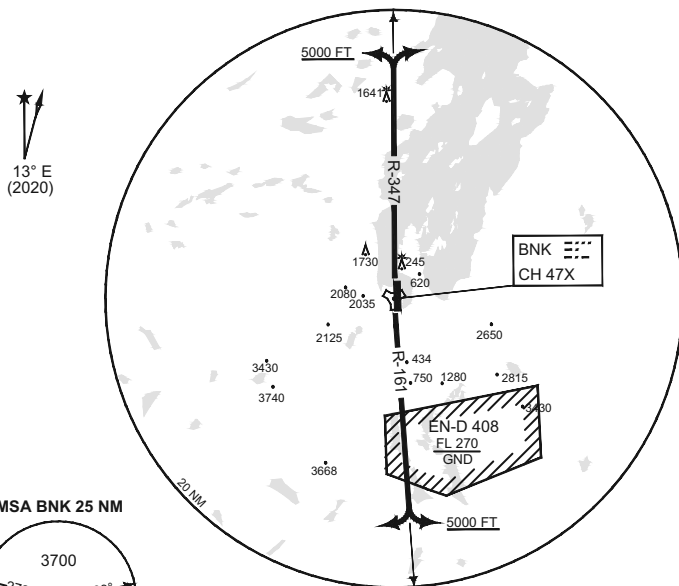

SAFE ALT 100 NM 7400

TA 7000

RWY 16	- Climb on BNK R-161. Passing 5000 ft turn according to ATC clearance, and continue climb to 7000 ft. - Obstacles (164 ft MSL) 0.3 NM after DER must be avoided visually.
RWY 34	- Climb on BNK R-347. Passing 5000 ft turn according to ATC clearance, and continue climb to 7000 ft.

CHANGES: FREQUENCIES

RNAIF 25 DEC 2025

TACAN SID RWY 16 / 34

70°04.00' N
024°58.43' E

BANAK (ENNA)

MIPS
INSTRUMENT APPROACH CHART

AD ELEV 26

LOC M RWY 16
BANAK (ENNA)

ATIS 136.330		BANAK TWR / APPR 118.905 118.055 257.800 280.350				
-----------------	--	---	--	--	--	--

LOCALIZER/DME BK 109.350 / CH 30Y	APP COURSE 163°	FAF ALT 2000	Descent GR 5.2% (3.0°)	MDA SEE CAT	THR ELEV 16	ALS 720 m	LDA 8838
--------------------------------------	--------------------	-----------------	---------------------------	-----------------------	----------------	--------------	-------------

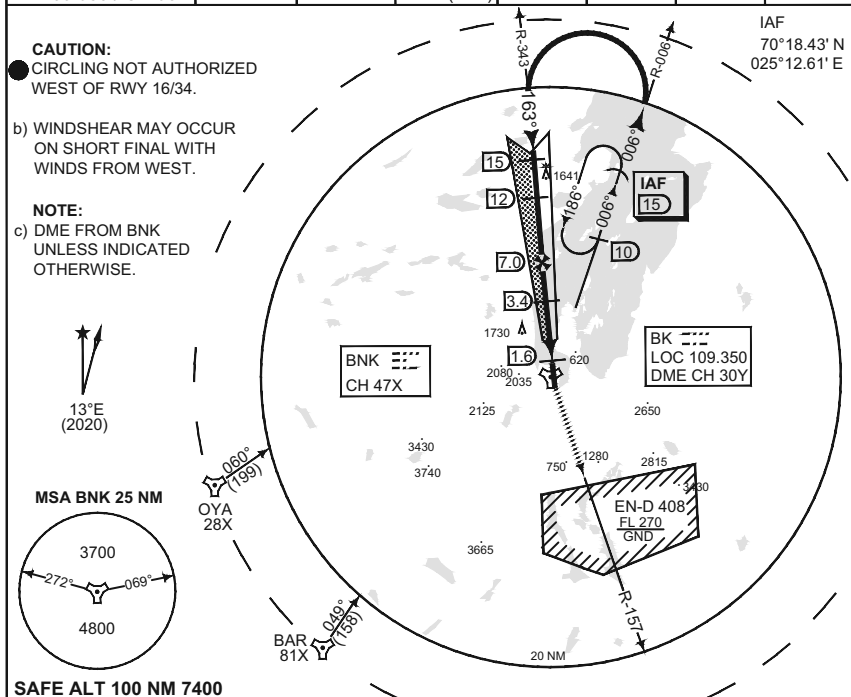

DME	7	6	5	4	3	2
ALT BNK	2000	1690	1370	1050	740	420
ALT BK	-	1810	1500	1180	860	550

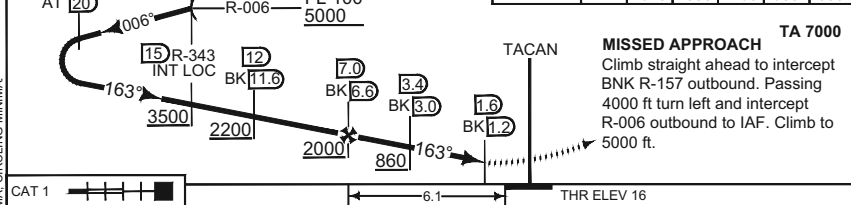

CATEGORY	A	B	C	D	E
----------	---	---	---	---	---

MIPS	S-LOC 16 2.5% MA	310 - 750 294 (300 - 0.8/1.4)	330 - 750 314 (400 - 0.8/1.4)	350 - 800 334 (400 - 0.8/1.5)	380 - 1000 364 (400 - 1.0/1.7)	
	S-LOC 16 3.0% MA	310 - 750 294 (300 - 0.8/1.4)				
	CIRCLING	690 - 3.1 664 (700 - 3.1)	990 - 4.5 964 (1000 - 4.5)	1350 - 5.0 1324 (1400 - 5.0)	2070 - 5.0 2044 (2100 - 5.0)	3190 - 5.0 3164 (3200 - 5.0)

LOC M RWY 16

70°04.00' N
024°58.43' E

BANAK (ENNA)

CHANGES: VISIBILITY MINIMA, CIRCLING MINIMA

RNOAF 16 APR 2026

MIPS
INSTRUMENT APPROACH CHART

AD ELEV 26

TACAN Y RWY 16
BANAK (ENNA)

ATIS 136.330		BANAK TWR / APPR 118.905 118.055 257.800 280.350					
TACAN BNK CH 47X	APP COURSE 168°	FAF ALT 2500	Descent GR 5.3% (3.0°)	MDA 1200	THR ELEV 16	ALS N/A	LDA 6070

CAUTION:
● CIRCLING NOT AUTHORIZED WEST OF RWY 16/34.

b) WINDSHEAR MAY OCCUR ON SHORT FINAL WITH WINDS FROM WEST.

NOTE:
c) FINAL OFFSET 6° EAST.

d) FINAL INTERSECTS EXT RWY CENTERLINE 888 M IN FRONT OF THR.

e) TEMPORARY PROCEDURE FOR DTHR. AVBL BY ATC.

f) ALS NOT INCLUDED IN VIS CALCULATION.

IAF
70°18.43' N
025°12.61' E

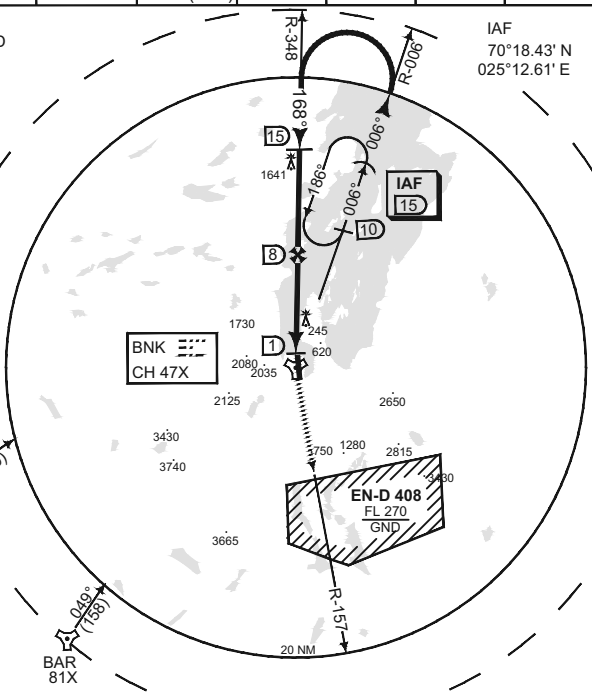
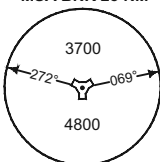

SAFE ALT 100 NM 7400

DME BNK	8	7	6	5	4
ALT	2500	2180	1860	1540	1220

TA 7000

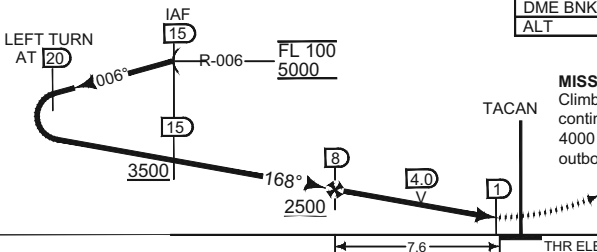

MISSED APPROACH

Climb and continue to BNK. Then continue on R-157 outbound. Passing 4000 ft turn left and intercept R-006 outbound to IAF. Climb to 5000 ft.

CHANGES: NEW PROCEDURE

CATEGORY	A	B	C	D	E
S-TAC 16	1200 - 5.0 1184 (1200 - 5.0)				
● CIRCLING	1200 - 5.0 1174 (1200 - 5.0)	1200 - 5.0 1174 (1200 - 5.0)	1350 - 5.0 1324 (1400 - 5.0)	2070 - 5.0 2044 (2100 - 5.0)	3190 - 5.0 3174 (3200 - 5.0)

TACAN Y RWY 16

70°04.00' N
024°58.43' E

BANAK (ENNA)

RNOA/16 APR 2026

MIPS
INSTRUMENT APPROACH CHART

AD ELEV 26

TACAN Z RWY 16
BANAK (ENNA)

ATIS 136.330		BANAK TWR / APPR 118.905 118.055 257.800 280.350					
TACAN BNK CH 47X	APP COURSE 168°	FAF ALT 2300	Descent GR 5.2% (3.0°)	MDA 1200	THR ELEV 16	ALS 720 m	LDA 8838

CAUTION:
● CIRCLING NOT AUTHORIZED WEST OF RWY 16/34.

b) WINDSHEAR MAY OCCUR ON SHORT FINAL WITH WINDS FROM WEST.

NOTE:

- c) FINAL OFFSET 6° EAST.
- d) FINAL INTERSECTS EXT RWY CENTERLINE 43 M IN FRONT OF THR.

IAF
70°18.43' N
025°12.61' E

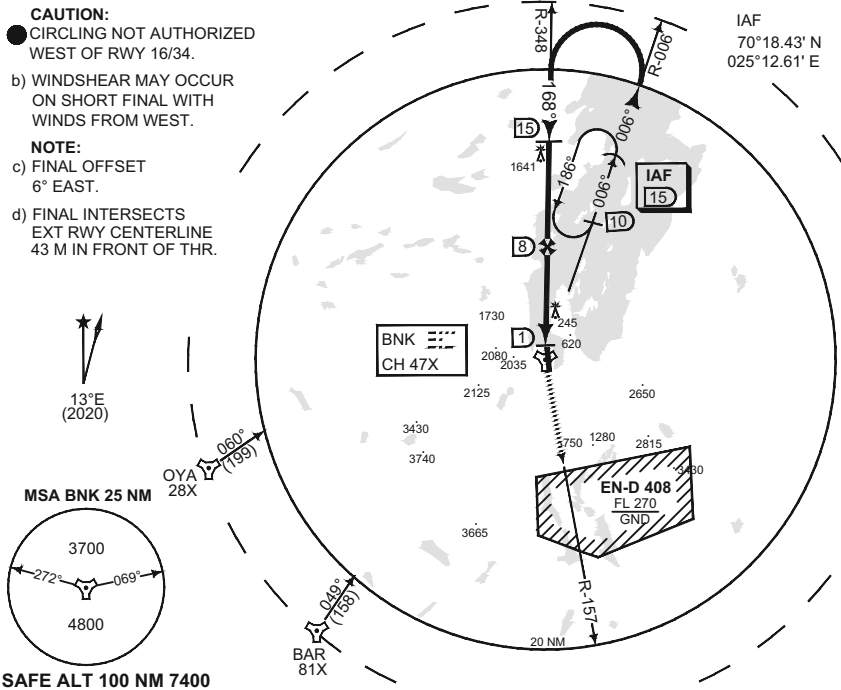

SAFE ALT 100 NM 7400

DME BNK	8	7	6	5
ALT	2300	1990	1680	1360

TA 7000

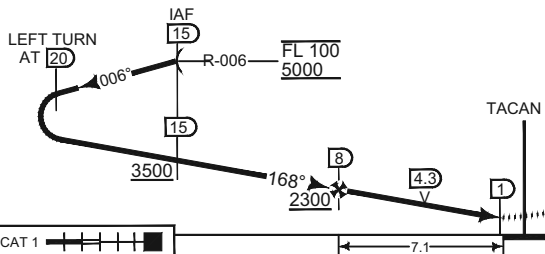

MISSED APPROACH
Climb and continue to BNK. Then continue on R-157 outbound. Passing 4000 ft turn left and intercept R-006 outbound to IAF. Climb to 5000 ft.

CAT 1	7.1					THR ELEV 16
-------	-----	--	--	--	--	-------------

CATEGORY	A	B	C	D	E
S-TAC 16	1200 - 4.6 1184 (1200 - 4.6/5.0)				
● CIRCLING	1200 - 5.0 1174 (1200 - 5.0)	1200 - 5.0 1174 (1200 - 5.0)	1350 - 5.0 1324 (1400 - 5.0)	2070 - 5.0 2044 (2100 - 5.0)	3190 - 5.0 3164 (3200 - 5.0)

TACAN Z RWY 16

70°04.00' N
024°58.43' E

BANAK (ENNA)

CHANGES: PROCEDURE NAME, APPROACH AND VISIBILITY MINIMA VALUES.

FRNGAF-16 APR 2026

MIPS INSTRUMENT APPROACH CHART

HPMA ILS or LOC RWY 34 BANAK (ENNA)

AD ELEV 26

ATIS 136.330	BANAK TWR / APPR 118.905 118.055 257.800 280.350			
-----------------	---	--	--	--

LOCALIZER/DME	APP COURSE	GS INTCP ALT	GS	DA	THR ELEV	ALS	LDA
BA 108.300 / CH 20X	342°	3500	3.5°	251	25	737 m	8543

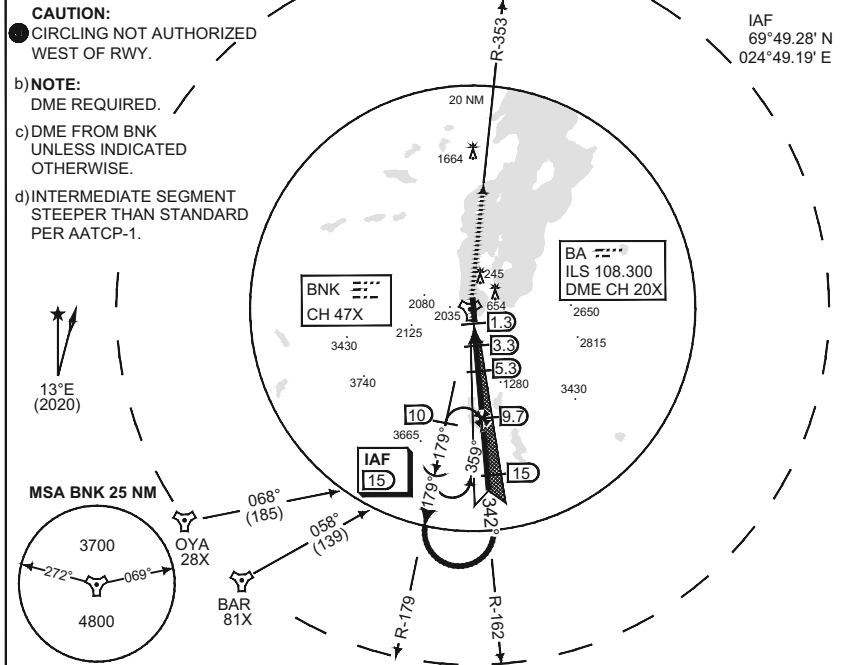

SAFE ALT 100 NM 7400

DME	2	3	4	5	6	7	8	9	FL 100	IAF 15	TA 7000
ALT BNK	-	1000	1380	1760	2140	2520	2910	3290	FL 90 -R-179	LEFT TURN AT 20	
ALT BA	760	1130	1510	1890	2270	2660	3040	3430			

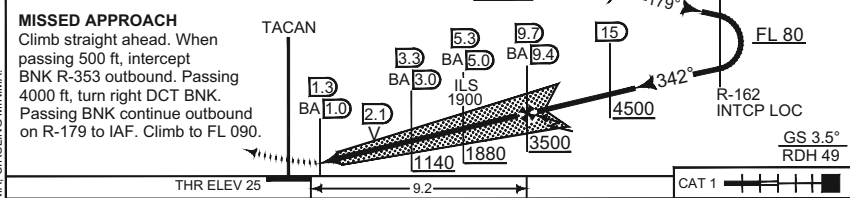

CATEGORY	HPMA
S-ILS 34	251 - 600 226 (300 - 0.8/1.3)
S-LOC 34	670 - 2.3 645 (700 - 2.3/3.0)
● CIRCLING	1100 - 4.9 1074 (1100 - 4.9)

HPMA ILS or LOC RWY 34 BANAK (ENNA)

70°04.00' N
024°58.43' E

CHANGES: VISIBILITY MINIMA, CIRCLING MINIMA

RNCAAF 10 APR 2026

MIPS INSTRUMENT APPROACH CHART

AD ELEV 26

ILS M or LOC M RWY 34 BANAK (ENNA)

ATIS 136.330		BANAK TWR / APPR 118.905 118.055 257.800 280.350					
LOCALIZER/DME BA 108.300 / CH 20X	APP COURSE 342°	GS INTCP ALT 3500	GS 3.5°	DA SEE CAT	THR ELEV 25	ALS 737 m	LDA 8543

CAUTION:
● CIRCLING NOT AUTHORIZED WEST OF RWY.

IAF
69°49.28' N
024°49.19' E

- b) **NOTE:**
DME REQUIRED.
- c) DME FROM BNK UNLESS INDICATED OTHERWISE.

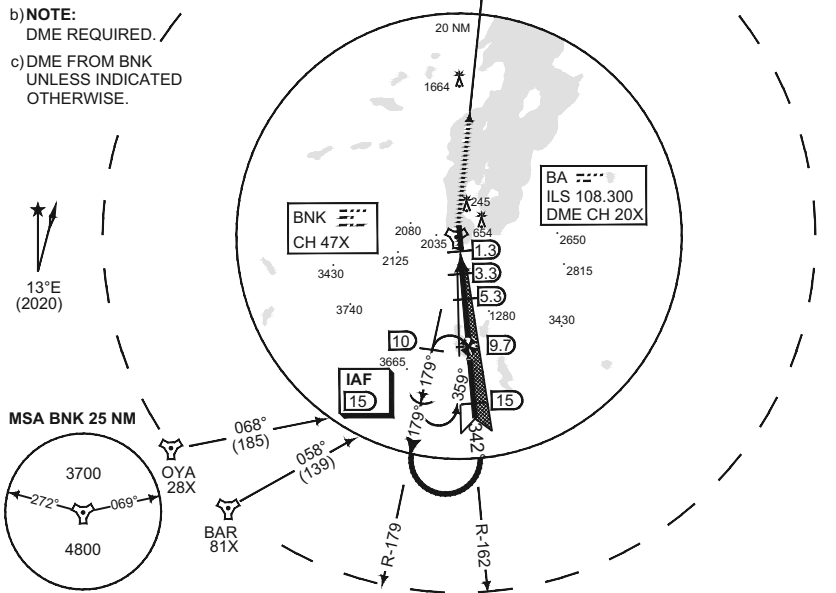

SAFE ALT 100 NM 7400

DME	2	3	4	5	6	7	8	9	
ALT BNK	-	1000	1380	1760	2140	2520	2910	3290	
ALT BA	760	1130	1510	1890	2270	2660	3040	3430	

MISSED APPROACH

Climb straight ahead. When passing 500 ft, intercept BNK R-353 outbound. Passing 4000 ft, turn right DCT BNK. Passing BNK continue outbound on R-179 to IAF. Climb to FL 090.

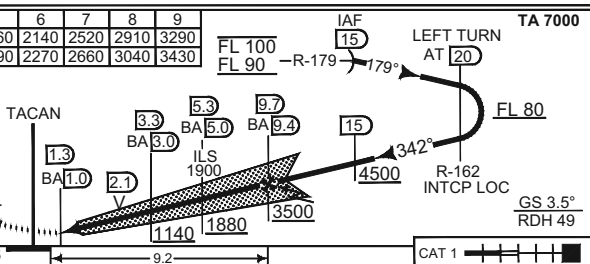

CATEGORY	A	B	C	D	E
S-ILS 34	287 - 600 262 (300 - 0.8/1.3)	302 - 600 277 (300 - 0.8/1.3)	312 - 650 287 (300 - 0.8/1.4)	325 - 650 300 (300 - 0.8/1.4)	330 - 700 305 (400 - 0.8/1.4)
S-LOC 34	670 - 2.3 645 (700 - 2.3/3.0)				
● CIRCLING	690 - 3.1 664 (700 - 3.1)	990 - 4.5 964 (1000 - 4.5)	1350 - 5.0 1324 (1400 - 5.0)	2070 - 5.0 2044 (2100 - 5.0)	3190 - 5.0 3164 (3200 - 5.0)

ILS M or LOC M RWY 34

70°04.00' N
024°58.43' E

BANAK (ENNA)

CHANGES: VISIBILITY MINIMA, CIRCLING MINIMA.

RNP APF 10 APR 2026

MIPS
INSTRUMENT APPROACH CHART

AD ELEV 26

TACAN Y RWY 34
BANAK (ENNA)

ATIS 136.330		BANAK TWR / APPR 118.905 118.055 257.800 280.350						
TACAN BNK CH 47X	APP COURSE 339°	FAF ALT 2800	Descent GR 6.0% (3.4°)	MDA 950	THR ELEV 25	ALS N/A	LDA 7215	

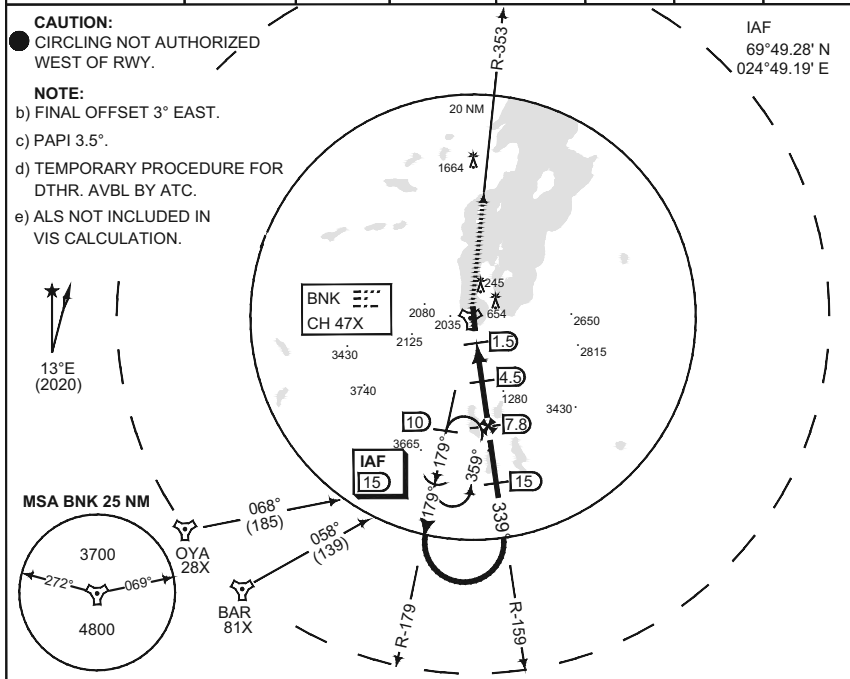

SAFE ALT 100 NM 7400

DME BNK	3	4	5	6	7
ALT	1060	1430	1790	2150	2510

MISSED APPROACH

At BNK 1.5 DME climb straight ahead and intercept R-353 outbound. Passing 4000 ft, turn right DCT BNK. Passing BNK continue outbound on R-179 to IAF. Climb to FL 090.

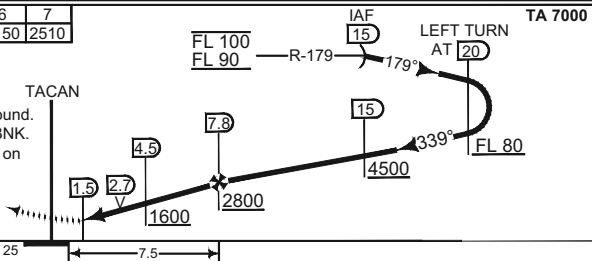

CATEGORY	A	B	C	D	E
S-TAC 34	950 - 4.3 925 (1000 - 4.3)				
● CIRCLING	950 - 4.3 924 (1000 - 4.3)	990 - 4.5 964 (1000 - 4.5)	1190 - 5.0 1164 (1200 - 5.0)	2040 - 5.0 2014 (2100 - 5.0)	3130 - 5.0 3104 (3200 - 5.0)

TACAN Y RWY 34

70°04.00' N
024°58.43' E

BANAK (ENNA)

CHANGES: NEW PROCEDURE MIPS

RND/AF 16 APR 2026

MIPS INSTRUMENT APPROACH CHART

AD ELEV 26

TACAN Z RWY 34 BANAK (ENNA)

ATIS 136.330		BANAK TWR / APPR 118.905 118.055 257.800 280.350					
TACAN BNK CH 47X	APP COURSE 339°	FAF ALT 2800	Descent GR 6.0% (3.4°)	MDA 950	THR ELEV 25	ALS 737 m	LDA 8543

CAUTION:
● CIRCLING NOT AUTHORIZED WEST OF RWY.

NOTE:
b) FINAL OFFSET 3° EAST.
c) PAPI 3.5°.

IAF
69°49.28' N
024°49.19' E

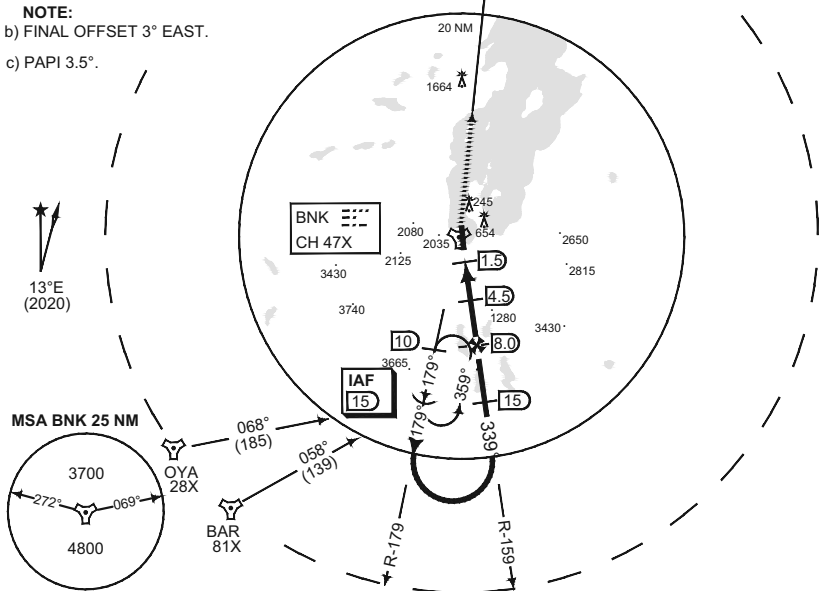

SAFE ALT 100 NM 7400

DME BNK	3	4	5	6	7	8
ALT	990	1350	1710	2080	2440	2800

MISSED APPROACH

At BNK 1.5 DME climb straight ahead and intercept R-353 outbound. Passing 4000 ft, turn right DCT BNK. Passing BNK continue outbound on R-179 to IAF. Climb to FL 090.

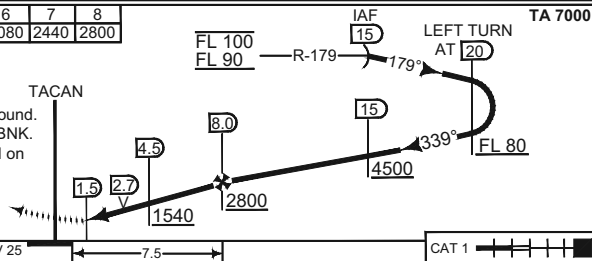

CHANGES PROCEDURE NAME, APPROACH AND VISIBILITY MINIMA VALUES, NOTES.

CATEGORY	A	B	C	D	E
S-TAC 34	950 - 3.6 925 (1000 - 3.6/4.3)				
● CIRCLING	950 - 4.3 924 (1000 - 4.3)	990 - 4.5 964 (1000 - 4.5)	1350 - 5.0 1324 (1400 - 5.0)	2070 - 5.0 2044 (2100 - 5.0)	3190 - 5.0 3164 (3200 - 5.0)

TACAN Z RWY 34

70°04.00' N
024°58.43' E

BANAK (ENNA)

FRNGAIF 16 APR 2026

AERODROME CHART

BARDUFOSS (ENDU)

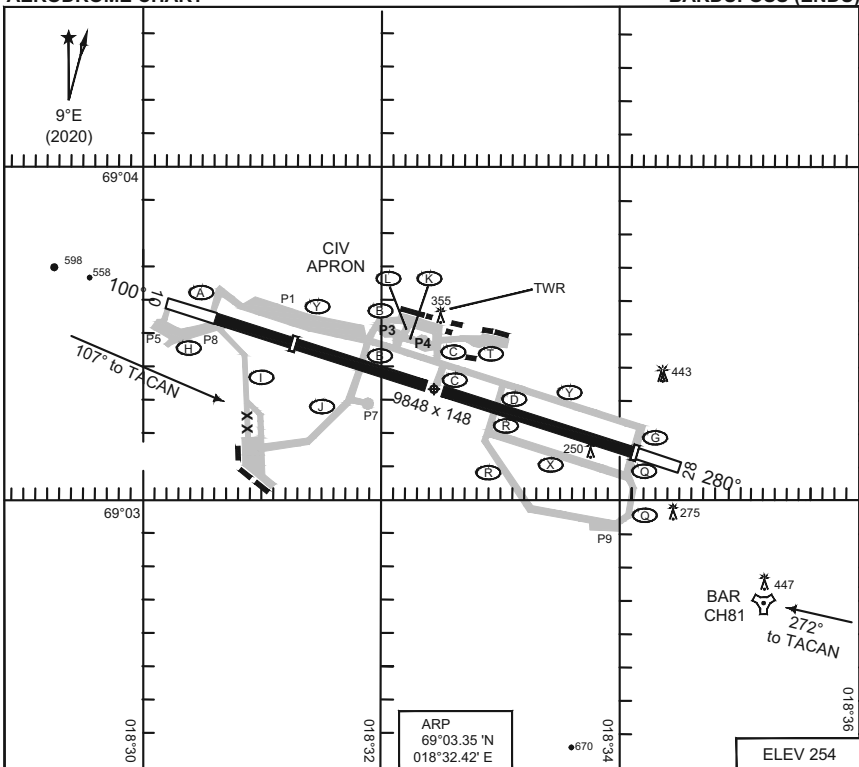

RWY	PCN	TORA	ASDA	TODA	LDA	PAPI	TDZE	THR PSN
10	75 F/C/W/T	8015*	8015	8015	6565	4.0°	253	69°03.49' N - 018°31.23' E
28	75 F/C/W/T	8015	8015	8015	8015	3.4°	219	69°03.14' N - 018°34.07' E

WARNING:

Special requirements for aircrew applies due to aerodrome category B, reference EASA AMC1 ORO.FC.105(b). Also refer to Bardufoss link found at <https://avinor.no/en/ais/pilot-briefing>.

* TORA RWY 10 starts from TWY A. Use of OVERRUN WEST from TWY A (TORA 8927 FT) requires ATC approval.

ATIS	129.730
BARDUFOSS CLR	122.100 257.800
BARDUFOSS TWR	118.105 280.700
BARDUFOSS APP	118.805 125.855 275.300 397.375
DE-ICE	131.750
BARDUFOSS MIL OPS	126.325 262.800

CHANGES: FREQUENCIES.

RNOAF 25 DEC 2025

AERODROME CHART

BARDUFOSS (ENDU)

**MIPS
INSTRUMENT DEPARTURE CHART**

**HPMA SID RWY 10
BARDUFOSS (ENDU)**

AD ELEV 254

ATIS 129.730	BARDUFOSS TWR 118.105 280.700	BARDUFOSS APP 118.805 125.855 275.300 397.375				POLARIS CONTROL S 126.455 N 126.705 S 278.050							
BARDUFOSS CLR 122.100 257.800		RWY 10	MIN CLIMB 8.75%	5.0°	GS (kt) V/V (fpm)	60 532	120 1064	180 1595	240 2127	300 2659	360 3190	to 7000	reason HPMA

WARNING:

- a) AERODROME CATEGORY B.
REFERENCE AERODROME
CHART FOR INFO.

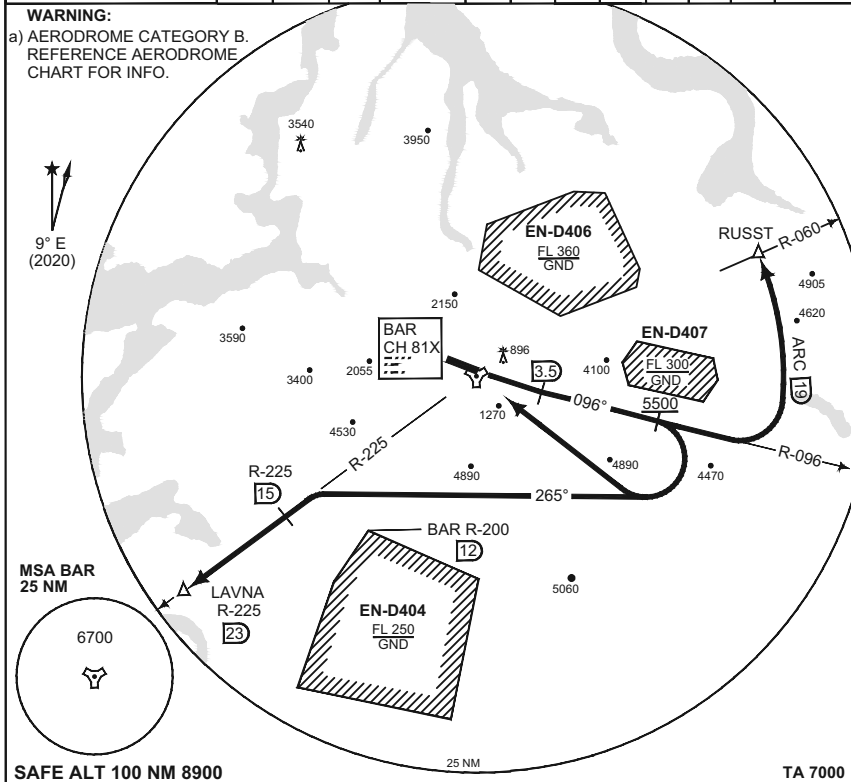

INITIAL CLIMB
Climb on track 100° to BAR 3.5 DME. Intercept BAR R-096 outbound and continue climb. Passing 5500 ft:

BARDUFOSS TACAN	- Turn right direct BAR. Maximum 350 KIAS in turn. Climb to 7000 ft.
LAVNA	- Turn right on track 265°. Intercept R-225 outbound no later than 15 DME. Proceed to LAVNA. Climb to 7000 ft. Remain clear of EN-D404 (BAR R-200 / 12 DME). Maximum 350 KIAS below 7000 ft.
RUSST	- Continue climb on R-096 outbound. Turn left to intercept 19 DME arc to RUSST. Maximum 350 KIAS in turn. Climb to FL 090.

HPMA SID RWY 10

69°03.35' N
018°32.42' E

BARDUFOSS (ENDU)

CHANGES: FREQUENCIES

RNOAF 25 DEC 2025

**MIPS
INSTRUMENT DEPARTURE CHART**

**TACAN SID RWY 10
BARDUFOSS (ENDU)**

AD ELEV 254

ATIS 129.730		BARDUFOSS TWR 118.105 280.700		BARDUFOSS APP 118.805 125.855 275.300 397.375				POLARIS CONTROL S 126.455 N 126.705 S 278.050					
BARDUFOSS CLR 122.100 257.800		RWY 10	MIN CLIMB 7.4%	4.3°	GS (kt) V/V (fpm)	60 450	120 900	180 1349	240 1799	300 2249	360 2698	to 7000	reason TERRAIN

WARNING:

- a) AERODROME CATEGORY B.
REFERENCE AERODROME
CHART FOR INFO.

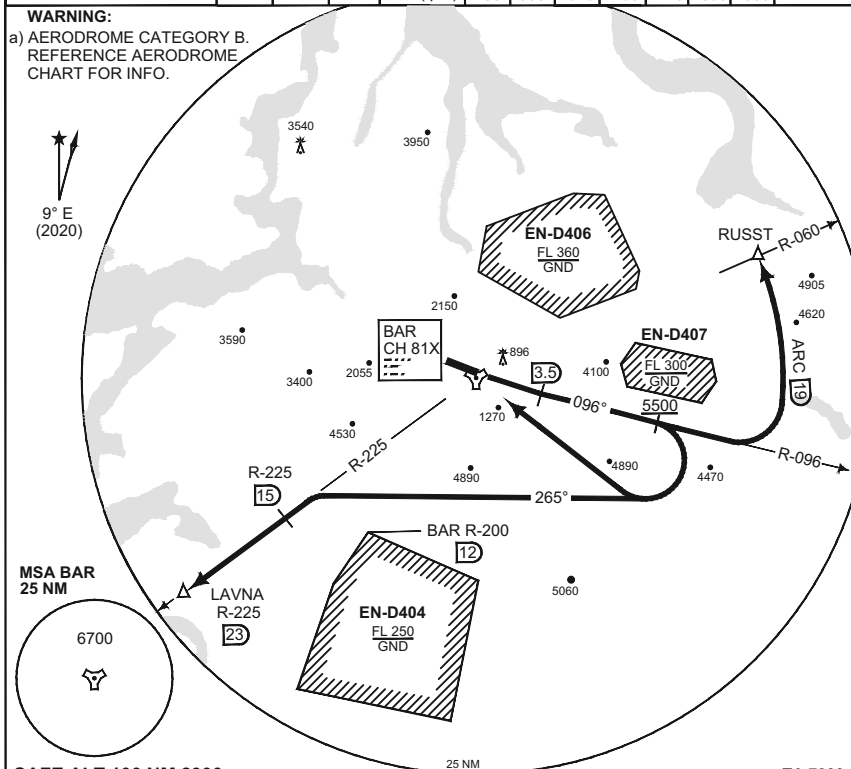

SAFE ALT 100 NM 8900

TA 7000

INITIAL CLIMB

Climb on track 100° to BAR 3.5 DME. Intercept BAR R-096 outbound and continue climb. Passing 5500 ft:

BARDUFOSS TACAN	- Turn right direct BAR. Maximum 300 KIAS in turn. Climb to 7000 ft.
LAVNA	- Turn right on track 265°. Intercept R-225 outbound no later than 15 DME. Proceed to LAVNA. Climb to 7000 ft. Remain clear of EN-D404 (BAR R-200 / 12 DME). Maximum 300 KIAS below 7000 ft.
RUSST	- Continue climb on R-096 outbound. Turn left to intercept 19 DME arc to RUSST. Maximum 300 KIAS in turn. Climb to FL 090.

CHANGES: FREQUENCIES

RNOGAF 25 DEC 2025

TACAN SID RWY 10

69°03.35' N
018°32.42' E

BARDUFOSS (ENDU)

**MIPS
INSTRUMENT DEPARTURE CHART**

AD ELEV 254

**HPMA SID RWY 28
BARDUFOSS (ENDU)**

ATIS 129.730	BARDUFOSS TWR 118.105 280.700	BARDUFOSS APP 118.805 125.855 275.300 397.375				POLARIS CONTROL S 126.455 N 126.705 S 278.050							
BARDUFOSS CLR 122.100 257.800		RWY 28	MIN CLIMB 8.75%	5.0°	GS (kt) V/V (fpm)	60 532	120 1064	180 1595	240 2127	300 2659	360 3190	to 7000	reason HPMA

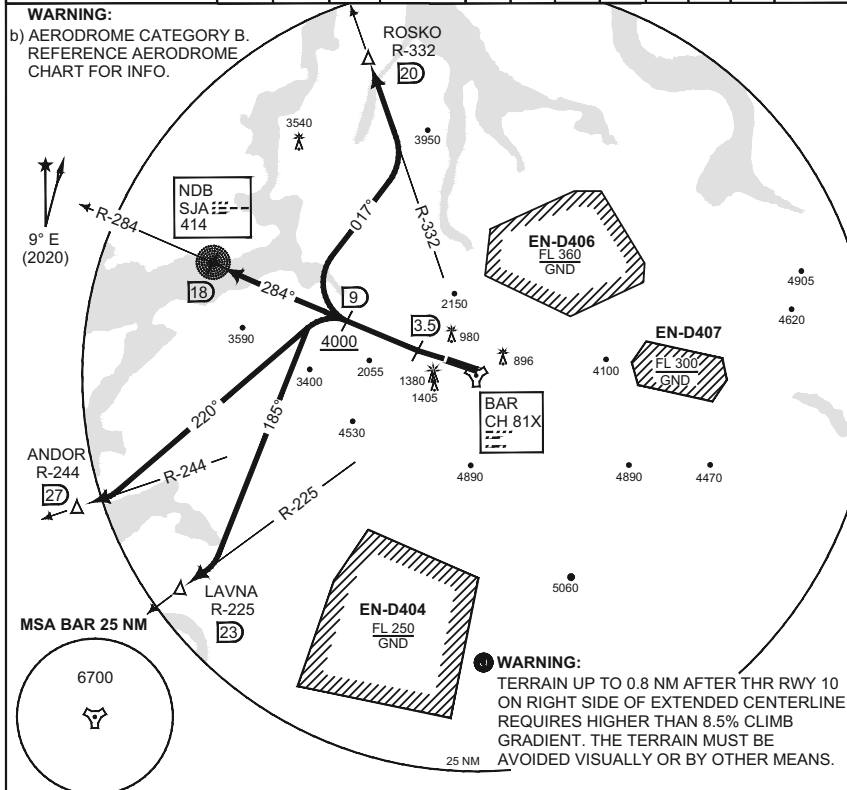

SAFE ALT 100 NM 8900 **TA 7000**

INITIAL CLIMB	Climb on track 280° to DME 3.5 BAR. Intercept R-284 outbound and continue climb. Cross DME 9 BAR at or above 4000 ft. Then:
ANDOR	Turn left on track 220°. Intercept R-244 to ANDOR. Climb to FL 150. Maximum 350 KIAS in turn.
LAVNA	Turn left on track 185°. Intercept R-225 BAR to LAVNA. Climb to 7000 ft. Maximum 350 KIAS in turn.
ROSKO	Turn right on track 017°. Intercept R-332 BAR to ROSKO. Climb to 7000 ft. Maximum 350 KIAS in turn.
SJA NDB (SENJA)	Continue on R-284 BAR to DME 18 BAR (SJA NDB). Climb to 7000 ft.

CHANGES: FREQUENCIES

RNOAF 25 DEC 2025

**MIPS
INSTRUMENT DEPARTURE CHART**

AD ELEV 254

**TACAN SID RWY 28
BARDUFOSS (ENDU)**

ATIS 129.730	BARDUFOSS TWR 118.105 280.700	BARDUFOSS APP 118.805 125.855 275.300 397.375				POLARIS CONTROL S 126.455 N 126.705 S 278.050							
BARDUFOSS CLR 122.100 257.800		RWY 28	MIN CLIMB 8.5%	4.9%	GS (kt) V/V (fpm)	60 517	120 1033	180 1550	240 2066	300 2583	360 3099	to 7000	reason TERRAIN

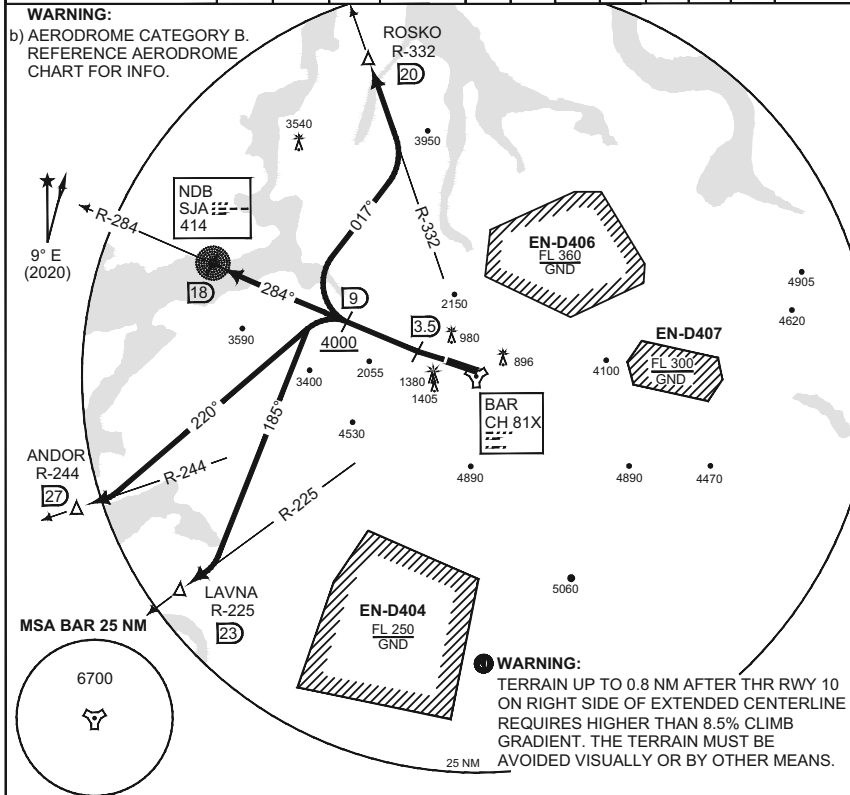

SAFE ALT 100 NM 8900 **TA 7000**

INITIAL CLIMB	Climb on track 280° to DME 3.5 BAR. Intercept R-284 outbound and continue climb. Cross DME 9 BAR at or above 4000 ft. Then:
ANDOR	Turn left on track 220°. Intercept R-244 to ANDOR. Climb to FL 150. Maximum 300 KIAS in turn.
LAVNA	Turn left on track 185°. Intercept R-225 BAR to LAVNA. Climb to 7000 ft. Maximum 300 KIAS in turn.
ROSKO	Turn right on track 017°. Intercept R-332 BAR to ROSKO. Climb to 7000 ft. Maximum 300 KIAS in turn.
SJA NDB (SENJA)	Continue on R-284 BAR to DME 18 BAR (SJA NDB). Climb to 7000 ft.

TACAN SID RWY 28 69°03.35' N
018°32.42' E **BARDUFOSS (ENDU)**

CHANGES: FREQUENCIES

RNCAP 25 DEC 2025

MIPS INSTRUMENT APPROACH CHART

TACAN RWY 10 BARDUFOSS (ENDU)

AD ELEV 254

ATIS 129.730	BARDUFOSS APP 118.805 125.855 275.300 397.375			BARDUFOSS TWR 118.105 280.700			
TACAN BAR CH 81X	APP COURSE 107°	FAF ALT 3100	Descent GR 6.3% (3.6°)	MDA SEE CAT	TDZE 253	ALS 2840 m	LDA 6565

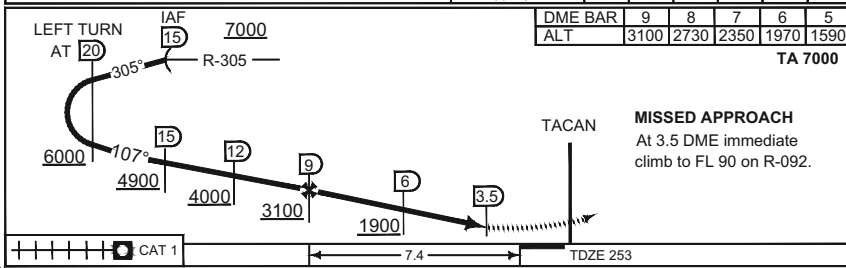
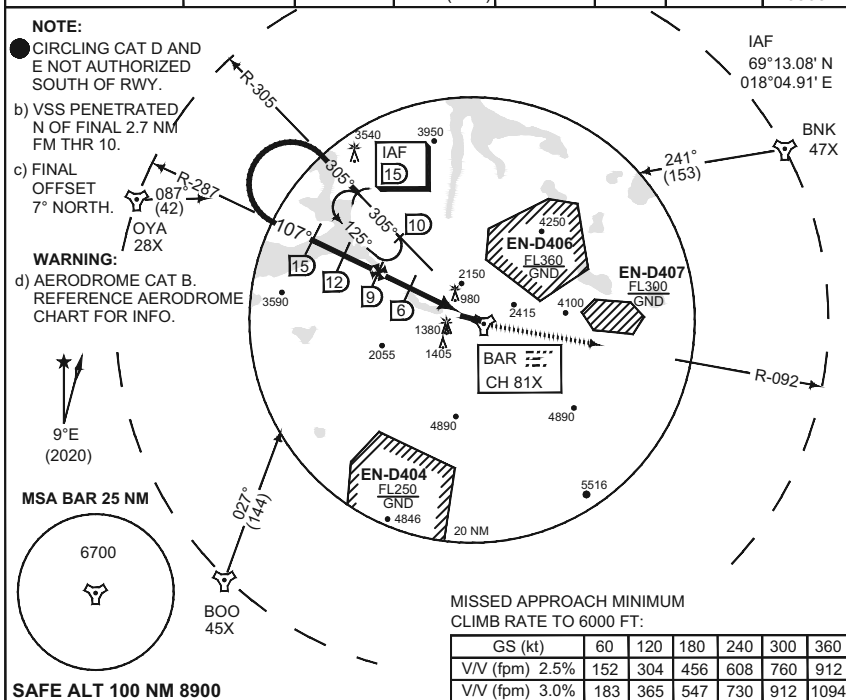

CHANGES FREQUENCIES	CATEGORY	C	D	E
MIPS	S-TAC 10 2.5% MA CLMB		1820 - 5.0 1567 (1600-5.0)	
	S-TAC 10 3.0% MA CLMB		1470 - 5.0 1217 (1300-5.0)	
	● CIRCLING	2540 - 5.0 2286 (2300-5.0)	2850 - 5.0 2596 (2600-5.0)	2950 - 5.0 2696 (2700-5.0)

TACAN RWY 10 BARDUFOSS (ENDU)

69°03'35" N 018°32'42" E

CHANGES FREQUENCIES

RNOAF 25 DEC 2025

**MIPS
INSTRUMENT APPROACH CHART**

AD ELEV 254

**LOC M RWY 10
BARDUFOSS (ENDU)**

ATIS 129.730	BARDUFOSS APP 118.805 125.855 275.300 397.375			BARDUFOSS TWR 118.105 280.700			
LOCALIZER/DME DU 110.300 / CH 81X	APP COURSE 100°	FAF ALT 4000	Descent GR 6.1% (3.5°)	MDA SEE CAT	TDZE 253	ALS 2840 m	LDA 6565

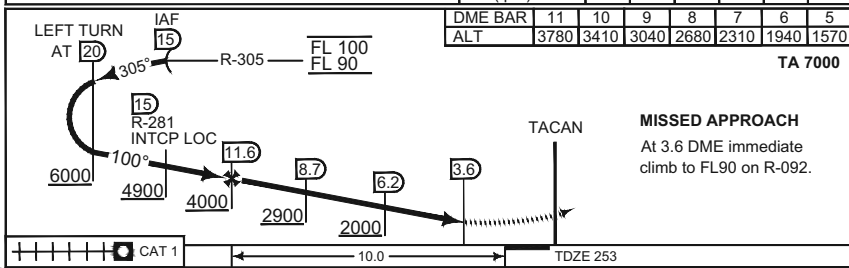
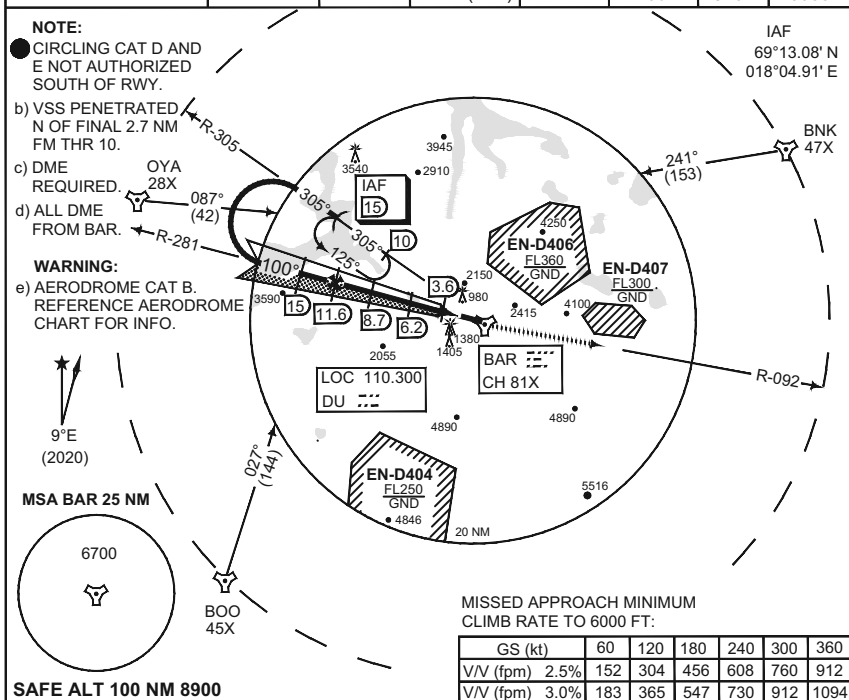

MIPS	CATEGORY	C		D		E	
		1760 - 5.0	1507 (1600 - 5.0)	1780 - 5.0	1527 (1600 - 5.0)	1820 - 5.0	1567 (1600 - 5.0)
	S-LOC 10 2.5% MA CLMB	1300 - 4100 1047 (1100 - 4.1/4.9)					
	S-LOC 10 3.0% MA CLMB						
	● CIRCLING	2540 - 5.0	2286 (2300 - 5.0)	2850 - 5.0	2596 (2600 - 5.0)	2950 - 5.0	2696 (2700 - 5.0)

LOC M RWY 10

69°03.35' N
018°32.42' E

BARDUFOSS (ENDU)

CHANGES: FREQUENCIES

RNOAF 25 DEC 2025

MIPS INSTRUMENT APPROACH CHART

HPMA ILS or LOC RWY 28 BARDUFOSS (ENDU)

AD ELEV 254

ATIS 129.730	BARDUFOSS APP 118.805 125.855 275.300 397.375				BARDUFOSS TWR 118.105 280.700			
LOCALIZER/DME BF 108.700 / CH 81X	APP COURSE 278°	GS INTCP ALT 5200	GS 3.7°	DA 636	TDZE 219	ALS 1340 m	LDA 8015	

NOTE:

- CIRCLING NOT AUTHORIZED SOUTH OF RWY.
- b) DME FROM BAR UNLESS OTHERWISE INDICATED.
- c) DME REQUIRED.
- d) LOC OFFSET 2° NORTH.
- e) LOC INTRC RADIAL AND LOC COURSE DIFFERS 1°.

WARNING:

- f) AERODROME CAT B. REFERENCE AERODROME CHART FOR INFO.

IAF
68°54.98' N
019°10.76' E

MSA BAR 25 NM

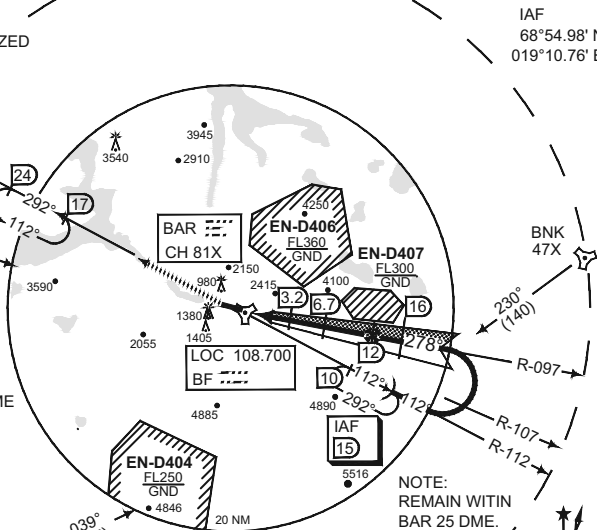
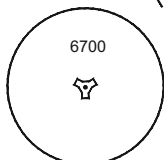

NOTE: REMAIN WITHIN BAR 25 DME.

MISSED APPROACH MINIMUM CLIMB RATE:

GS (kt)	60	120	180	240	300	360
V/V (fpm)	370	730	1100	1460	1830	2190

SAFE ALT 100 NM 8900

DME	1	2	3	4	5	6	7	8	9	10	11	12	FL 120	TA 7000
ALT BAR	890	1280	1680	2080	2480	2890	3290	3700	4110	4520	4930	-	15 FL 100	20 LEFT TURN
ALT BF	-	1010	1410	1810	2210	2610	3020	3420	3830	4240	4650	5060		

MISSED APPROACH

Climb straight ahead. Passing 1000 ft, intercept BAR R-292 outbound. Enter holding at BAR 17 DME. Climb to 5100 ft.

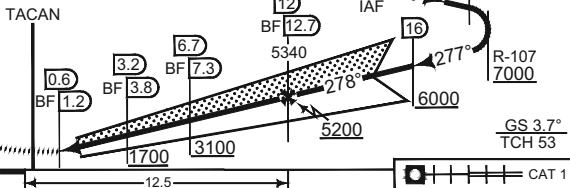

CHANGES: FREQUENCIES MIPS	CATEGORY	HPMA
	S-ILS 28	636 - 1200 417 (500 - 1.2/1.9)
	S-LOC 28	820 - 2100 601 (700 - 2.1/2.8)
	● CIRCLING	1860 - 5.0 1603 (1700 - 5.0)

HPMA ILS or LOC RWY 28

69°03.35' N
018°32.42' E

BARDUFOSS (ENDU)

MIPS
INSTRUMENT APPROACH CHART

ILS M or LOC M RWY 28
BARDUFOSS (ENDU)

AD ELEV 254

ATIS 129.730	BARDUFOSS APP 118.805 125.855 275.300 397.375				BARDUFOSS TWR 118.105 280.700			
LOCALIZER/DME BF 108.700 / CH 81X	APP COURSE 278°	GS INTCP ALT 5200	GS 3.7°	DA SEE CAT	TDZE 219	ALS 1340 m	LDA 8015	

NOTE:

● CIRCLING CAT D AND E NOT AUTHORIZED SOUTH OF RWY.

b) DME FROM BAR UNLESS OTHERWISE INDICATED.

c) DME REQUIRED.

d) LOC OFFSET 2° NORTH.

e) LOC INTRC RADIAL AND LOC COURSE DIFFERS 1°.

WARNING:

f) AERODROME CAT B. REFERENCE AERODROME CHART FOR INFO.

IAF
68°54.98' N
019°10.76' E

MSA BAR 25 NM

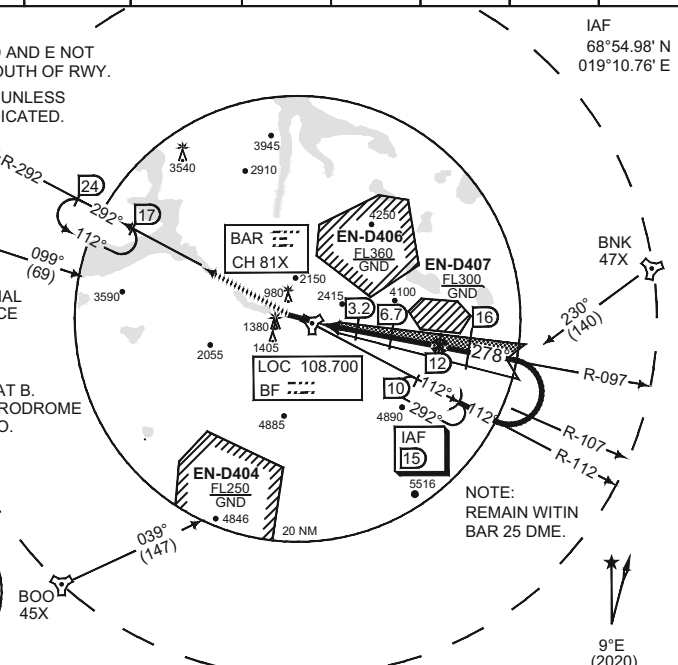
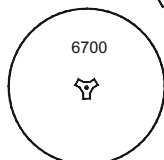

NOTE:
REMAIN WITHIN
BAR 25 DME.

SAFE ALT 100 NM 8900

DME	1	2	3	4	5	6	7	8	9	10	11	12	FL 120	TA 7000
ALT BAR	890	1280	1680	2080	2480	2890	3290	3700	4110	4520	4930	-	15 FL 100	20 LEFT TURN
ALT BF	-	1010	1410	1810	2210	2610	3020	3420	3830	4240	4650	5060		

MISSED APPROACH

Climb straight ahead. Passing 1000 ft, intercept BAR R-292 outbound. Enter holding at BAR 17 DME. Climb to 5100 ft.

TACAN

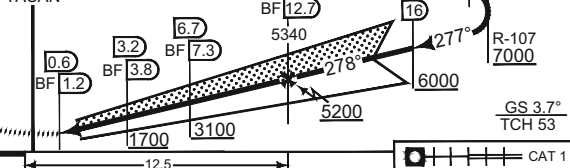

CHANGES: FREQUENCIES

CATEGORY	C	D	E
S-ILS 28	873 - 2300 654 (700 - 2.3/3.0)	886 - 2400 667 (700 - 2.4/3.1)	911 - 2.5 692 (700 - 3.2)
S-LOC 28	880 - 2400 661 (700 - 2.4/3.1)	890 - 2400 671 (700 - 2.4/3.1)	920 - 2.6 701 (800 - 3.3)
● CIRCLING	2540 - 5.0 2286 (2300 - 5.0)	2850 - 5.0 2596 (2600 - 5.0)	2950 - 5.0 2696 (2700 - 5.0)

ILS M or LOC M RWY 28

69°03.35' N
018°32.42' E

BARDUFOSS (ENDU)

FRN04F 25 DEC 2025

MIPS
INSTRUMENT APPROACH CHART

AD ELEV 254

TACAN RWY 28
BARDUFOSS (ENDU)

ATIS 129.730	BARDUFOSS APP 118.805 125.855 275.300 397.375			BARDUFOSS TWR 118.105 280.700			
TACAN BAR CH 81X	APP COURSE 272°	FAF ALT 4300	Descent GR 7.8% (4.5°)	MDA 1240	TDZE 219	ALS 1340 m	LDA 8015

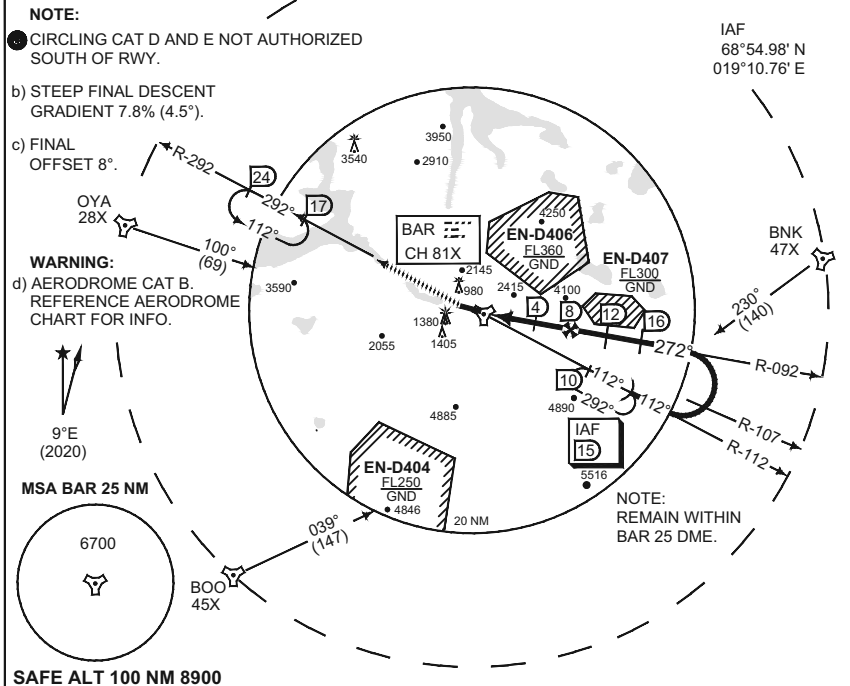

DME BAR	2	3	4	5	6	7	
ALT	1460	1930	2410	2880	3360	3830	

FL 120 (15) IAF FL 100 (20) LEFT TURN TA 7000

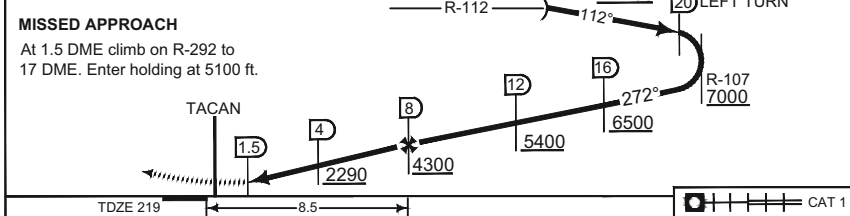

CHANGES: FREQUENCIES	CATEGORY	C	D	E
MIPS	S-TAC 28		1240 - 4.1 1021 (1100 - 4.9)	
●	CIRCLING	2540 - 5.0 2286 (2300 - 5.0)	2850 - 5.0 2596 (2600 - 5.0)	2950 - 5.0 2696 (2700 - 5.0)

TACAN RWY 28

69°03.35' N
018°32.42' E

BARDUFOSS (ENDU)

RNOAF 25 DEC 2025

AERODROME CHART

BEAUVECHAIN (EBBE)

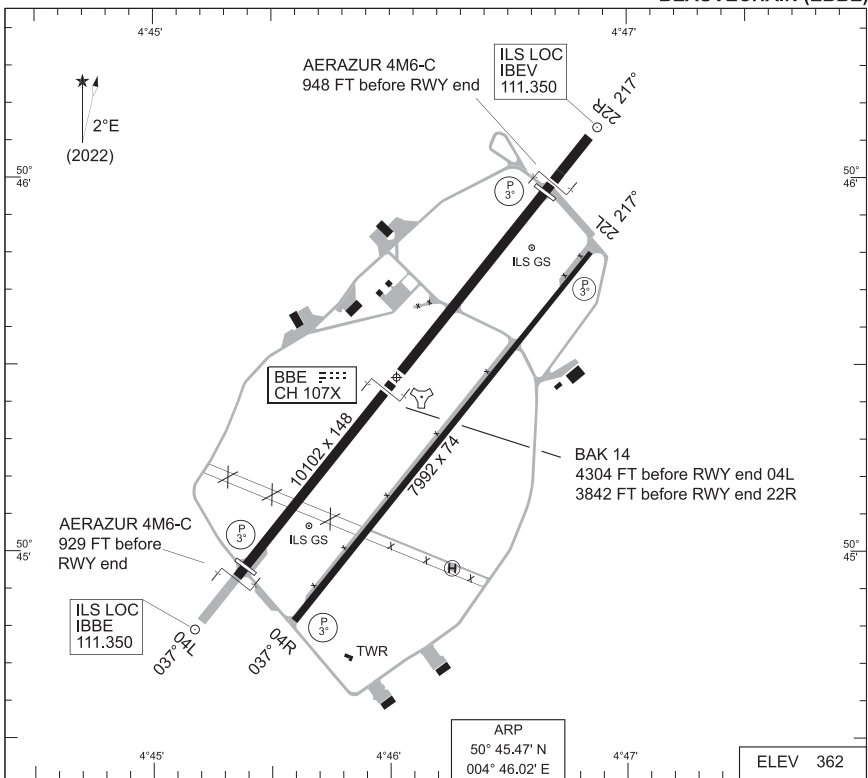

RWY	PCN	TORA	ASDA	TODA	LDA	PAPI	THR	TDZE	THR PSN
04L	93 F/C/W/T	8996	9904	9986	7959	3°	349	350	50° 44.96' N - 004° 45.39' E
22R	93 F/C/W/T	9055	9904	10019	7988	3°	315	331	50° 45.96' N - 004° 46.65' E
04R	24 F/B/W/T	7992	7992	7992	7792	3°	362	362	50° 44.83' N - 004° 45.61' E
22L	24 F/B/W/T	7992	7992	7992	7795	3°	316	333	50° 45.80' N - 004° 46.84' E

BEAUVECHAIN APP	282,100	362,300	122,830	122,505	BEAUVECHAIN TWR	362,025	257,800	130,730	122,100
BEAUVECHAIN GND	121,855	359,825	122,100		BEAUVECHAIN FINAL	378,525	276,850	119,630	123,300

	PROC. CRITERIA	RWY	GS	TCH	OTCH	RPI	CAT	MINIMA CRITERIA	MINIMA

AERODROME CHART

BEAUVECHAIN (EBBE)

CHANGE: Editorial

BELDEFENCE, AIR COMPONENT 16-APR-2026 - THS

MIPS
INSTRUMENT DEPARTURE CHART

AD ELEV 362

HPMA BE 04A - 04B
BEAUVECHAIN (EBBE)

BEAUVECHAIN GND 359.825 121.855		BEAUVECHAIN TWR 362.025 130.730		BEAUVECHAIN APP 282.100 122.830		BELGA RADAR 374.400 129.325			
TACAN BBE - CH 107X		RWY 04L	PDG 8.75%	From-To DER-3000	120 1070	180 1600	240 2130	300 2660	Reason HPMA

NOTE:

- MAX 300 KT IAS.

CAUTION:

ⓐ BE 04A CAN ONLY BE EXECUTED IF EB-R05A, EB-R05C & EB-R05D ARE NOT ACTIVE.

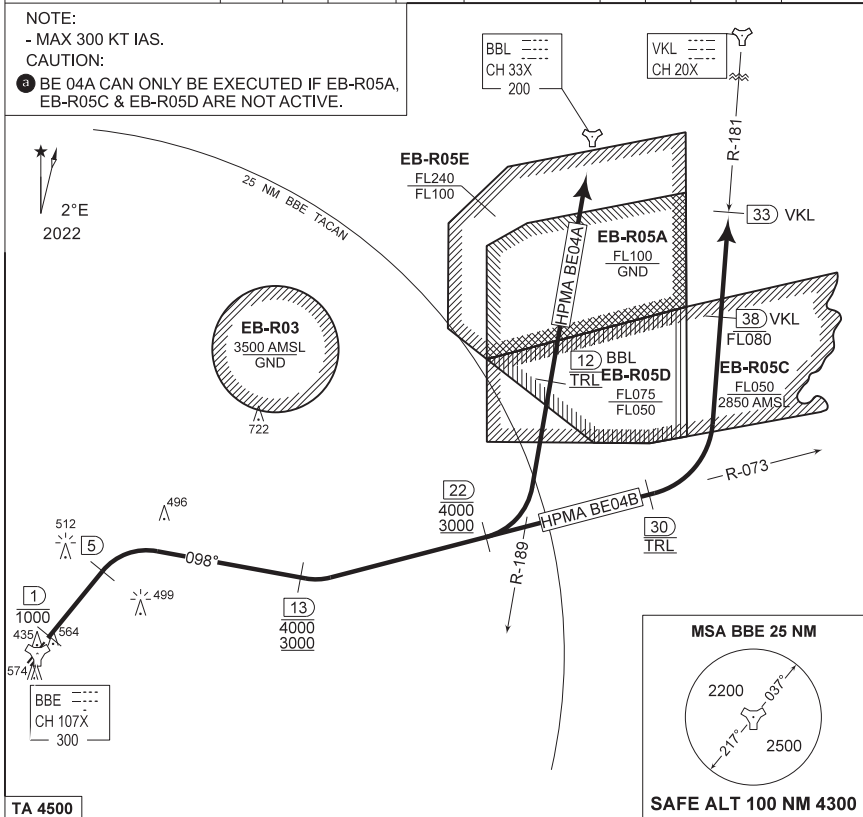

TA 4500

SAFE ALT 100 NM 4300

HPMA BE 04
(RWY 04L)

- Climb on track 037° (MAX 300 KT IAS) and contact EBBE APP.
- Pass 1 DME at or below 1000 FT.
- At 5 DME turn right and track 098° to intercept R-073 BBE TACAN outbound.
- Pass R-073 13 DME and 22 DME at 3000 FT AMSL or 4000 FT AMSL as instructed.
- Contact BELGA RADAR.

A ⓐ
44

- At 22 DME / R-073 turn left to intercept R-189 inbound BBL TACAN.
- Pass 12 DME / R-189 BBL at TRL.
- Climb as directed.

B
47

- Pass 30 DME / R-073 at TRL and then turn left to intercept R-181 inbound VKL TACAN.
- Pass 38 DME / R-181 VKL at or below FL080.
- Climb as directed.

CHANGE: Editorial

HPMA BE 04A - 04B

50°45,47' N
004°46,02' E

BEAUVECHAIN (EBBE)

BEL DEFENCE. AIR COMPONENT 16-APR-2026 - THS

**MIPS
INSTRUMENT DEPARTURE CHART**

AD ELEV 362

**HPMA BE 04E - 22E
BEAUVECHAIN (EBBE)**

BEAUVECHAIN GND 359.825 121.855	BEAUVECHAIN TWR 362.025 130.730	BEAUVECHAIN APP 282.100 122.830	BELGA RADAR 374.400 129.325					
TACAN BBE - CH 107X	RWY 04L 8.75% 5.00°	PDG 5.00°	From-To DER-4000	120 1070	180 1600	240 2130	300 2660	Reason HPMA
NOTE: - MAX 300 KT IAS.	22R 8.75% 5.00°		DER-4000	1070	1600	2130	2660	HPMA

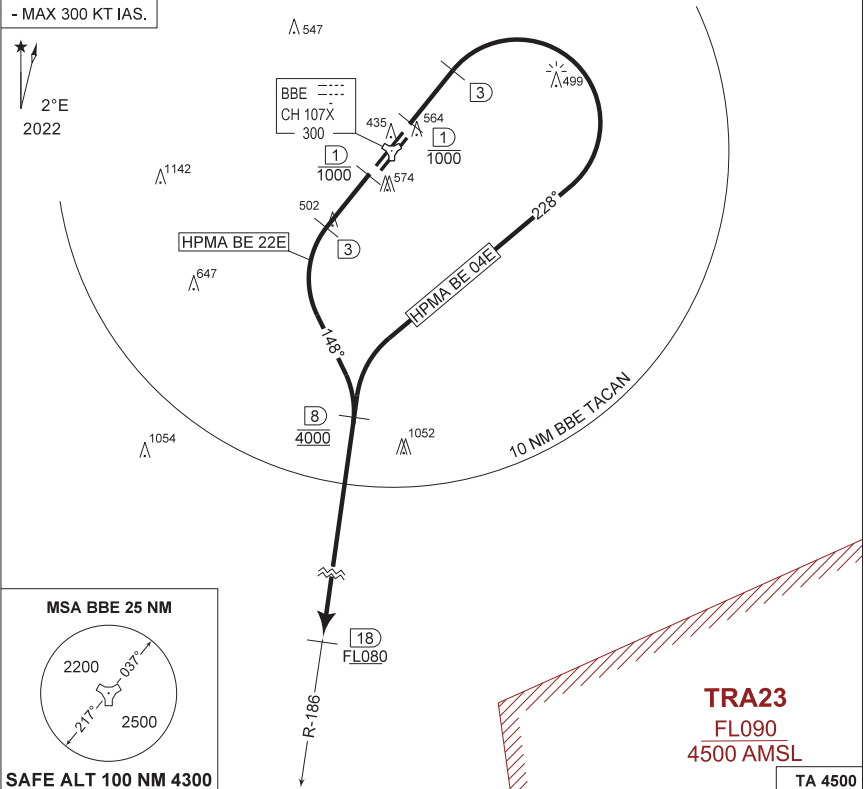

MSA BBE 25 NM

SAFE ALT 100 NM 4300

**TRA23
FL090
4500 AMSL**

TA 4500

HPMA BE 04E (RWY 04L) 31	<ul style="list-style-type: none"> - Climb on track 037° (MAX 300 KT IAS) and contact EBBE APP. - Pass 1 DME at or below 1000 FT. - At 3 DME turn right on track 228° to intercept R-186 outbound. - Pass 8 DME / R-186 at 4000 FT AMSL. - Contact BELGA RADAR passing 4500 FT AMSL. - Pass 18 DME / R-186 at FL080 or above. Climb as directed.
HPMA BE 22E (RWY 22R) 19	<ul style="list-style-type: none"> - Climb on track 217° (MAX 300 KT IAS) and contact EBBE APP. - Pass 1 DME at or below 1000 FT. - At 3 DME turn left on track 148° to intercept R-186 outbound. - Pass 8 DME / R-186 at 4000 FT AMSL. - Contact BELGA RADAR passing 4500 FT AMSL. - Pass 18 DME / R-186 at FL080 or above. Climb as directed.

CHANGE: Editorial

BEL DEFENCE: AIR COMPONENT 16-APR-2026 - THIS

HPMA BE 04E - 22E

50°45,47' N
004°46,02' E

BEAUVECHAIN (EBBE)

MIPS
INSTRUMENT DEPARTURE CHART

AD ELEV 362

HPMA BE 22A - 22B
BEAUVECHAIN (EBBE)

BEAUVECHAIN GND 359.825 121.855		BEAUVECHAIN TWR 362.025 130.730		BEAUVECHAIN APP 282.100 122.830		BELGA RADAR 374.400 129.325			
TACAN BBE - CH 107X		RWY 22R	PDG 8.75%	From-To DER-4000	120 1070	180 1600	240 2130	300 2660	Reason HPMA

NOTE:

- MAX 300 KT IAS.

CAUTION:

- BE 22A CAN ONLY BE EXECUTED IF EB-R05A, EB-05C & EB-R05D ARE NOT ACTIVE.

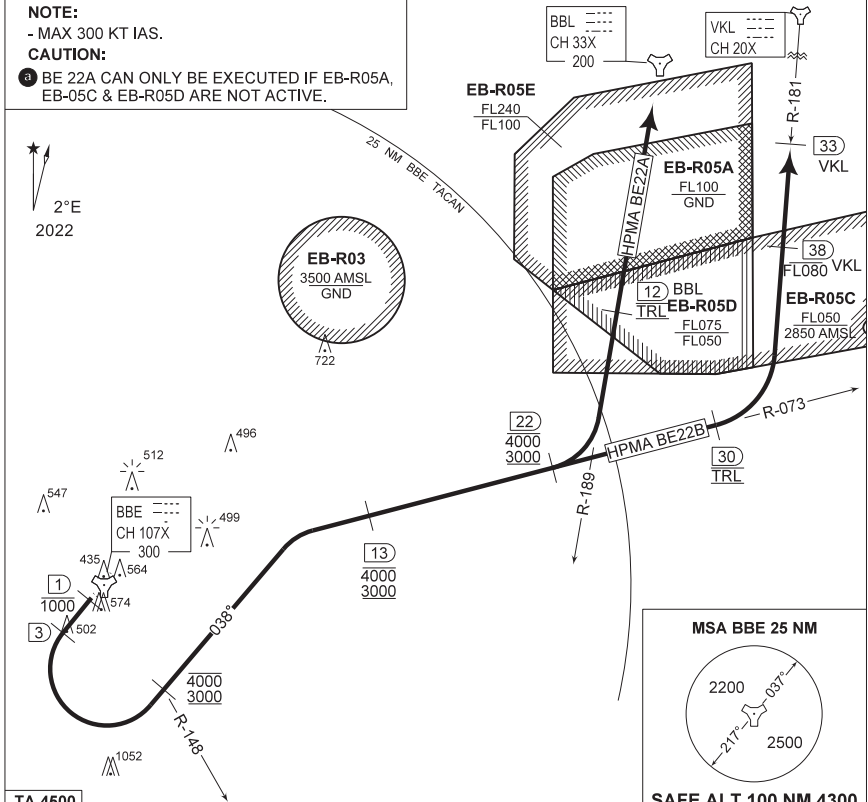

TA 4500

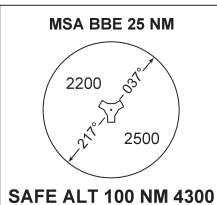

HPMA BE 22 (RWY 22R)	<ul style="list-style-type: none"> - Climb on track 217° (MAX 300 KT IAS) and contact EBBE APP. - Pass 1 DME at or below 1000 FT. At 3 DME turn left on track 038°. - Pass R-148 at 3000 FT or 4000 FT as instructed. - Intercept R-073 BBE TACAN outbound. - Pass 13 DME and 22 DME at 3000 FT AMSL or 4000 FT AMSL instructed. - Contact BELGA RADAR.
A	<ul style="list-style-type: none"> - At 22 DME / R-073 turn left to intercept R-189 inbound BBL TACAN. - Pass 12 DME / R-189 BBL at TRL. - Climb as directed.
B	<ul style="list-style-type: none"> - Pass 30 DME / R-073 at TRL and then turn left to intercept R-181 inbound VKL TACAN. - Pass 38 DME / R-181 VKL at or below FL080. - Climb as directed.

CHANGE: Editorial

BEL DEFENCE: AIR COMPONENT 16-APR-2026 - THIS

HPMA BE 22A - 22B

50°45,47' N
004°46,02' E

BEAUVECHAIN (EBBE)

MIPS
INSTRUMENT APPROACH CHART

AD ELEV 362

ILS y or LOC y RWY 04L
BEAUVECHAIN (EBBE)

BELGA RADAR 374.400 129.325		BEAUVECHAIN APP 282.100 122.830		BEAUVECHAIN TWR 362.025 130.730		BEAUVECHAIN GND 359.825 121.855	
LOC / DME IBEV 111.350 / 107X		APP COURSE 037°	GS INTCP ALT 1800 FT	GS 3.00°	DA 549	THR 349 FT	ALS LDA 930 M 7959 FT

NOTE:
a) IF IAF IS ABOVE 3000 FT, ATC COORDINATION WITH BRUSSELS ACC IS REQUIRED

IAF
50°43.68'N
004°44.55'E

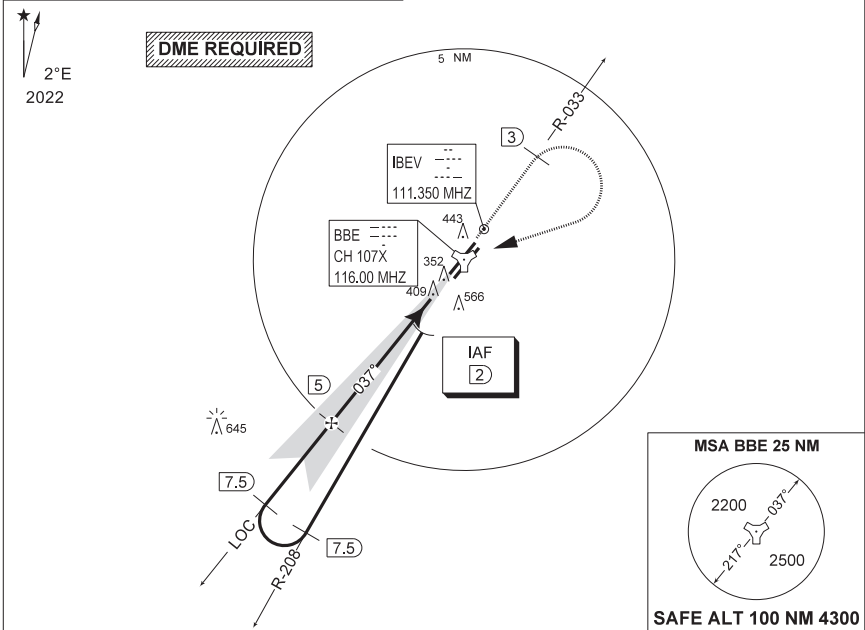

DME BBE	5	4	3	2	(7.5)	TA 4500
Altitude	1790	1470	1150	830	2500	
Height	(1441)	(1121)	(801)	(481)	2200	

MISSED APPROACH
Climb to 1000 FT RWY track and intercept R-033. At 2 DME past TACAN climb to 3000 FT. Passing 1500 FT or 3 DME whichever comes the latest, turn right inbound BBE TACAN and proceed back to IAF ILS y RWY 04L.

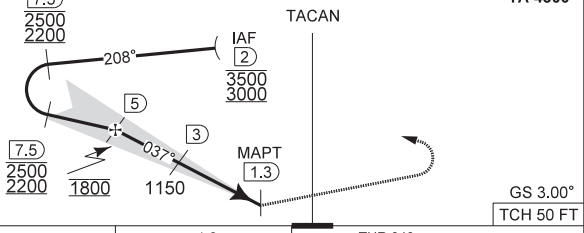

CATI	4.3	THR 349	GS 3.00°	TCH 50 FT
------	-----	---------	----------	-----------

CATEGORY	A	
S-ILS 04L	549 - 0.8 200 (200 - 0.8 / 0.9) GS 3.00°	
S-LOC 04L	750 - 1.2 401 (500 - 1.2 / 2.1)	

CHANGE: Editorial

ILS y or LOC y RWY 04L

50°45,47' N
004°46,02' E

BEAUVECHAIN (EBBE)

BEL DEFENCE, AIR COMPONENT 16-APR-2026 -THS

MIPS
INSTRUMENT APPROACH CHART

AD ELEV 362

ILS z or LOC z RWY 04L
BEAUVECHAIN (EBBE)

BELGA RADAR 374.400 129.325		BEAUVECHAIN APP 282.100 122.830		BEAUVECHAIN TWR 362.025 130.730		BEAUVECHAIN GND 359.825 121.855	
LOC / DME IBEV 111.350 / 107X	APP COURSE 037°	GS INTCP ALT 1800 FT	GS 3.00°	DA 549	THR 349 FT	ALS 930 M	LDA 7959 FT

NOTE:
a) HOLDING AT 4000 FT UNDER RADAR CONTROL MANDATORY

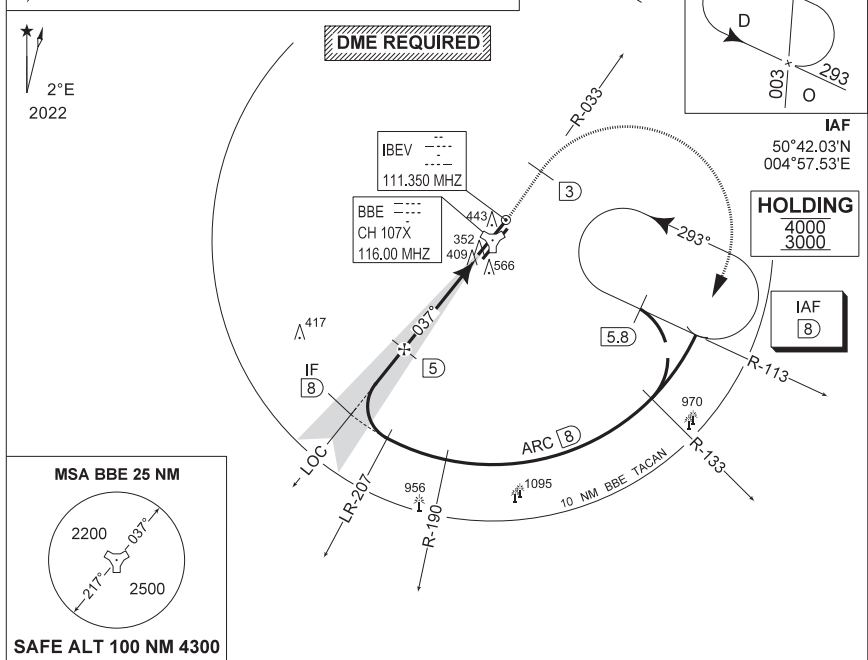

DME BBE	5	4	3	2
Altitude	1790	1470	1150	830
Height	(1441)	(1121)	(801)	(481)

MISSED APPROACH

Climb to 1000 FT RWY track and intercept R-033. At 2 DME past TACAN climb to 3000 FT. Passing 1500 FT or 3 DME whichever comes the latest, turn right at MAX 250 KIAS to intercept R-113 towards IAF ILS z RWY 04L.

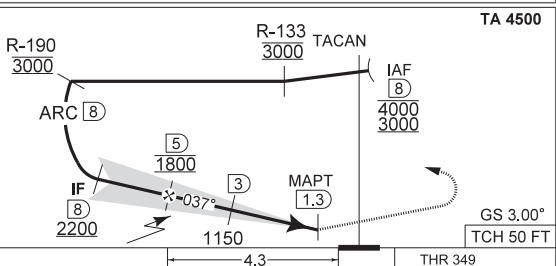

CATI

CATEGORY	A	B	C	D	HPMA
S-ILS 04L		549 - 0.8 200 (200 - 0.8 / 0.9) GS 3.00°			
S-LOC 04L		750 - 1.2 401 (500 - 1.2 / 2.1)			

CHANGE: Editorial
MIPS

ILS z or LOC z RWY 04L

50°45.47' N
004°46.02' E

BEAUVECHAIN (EBBE)

BEL DEFENCE. AIR COMPONENT 16-APR-2028 - THS

MIPS
INSTRUMENT APPROACH CHART

HPMA TACAN RWY 04L
BEAUVECHAIN (EBBE)

AD ELEV 362

BELGA RADAR 374.400 129.325		BEAUVECHAIN APP 282.100 122.830		BEAUVECHAIN TWR 362.025 130.730		BEAUVECHAIN GND 359.825 121.855	
TACAN BBE CH107X	APP COURSE 041°	FAF ALT 1800 FT	DESCENT GR 5.24%(3°)	MDA 770	THR 349 FT	ALS 930 M	LDA 7959 FT

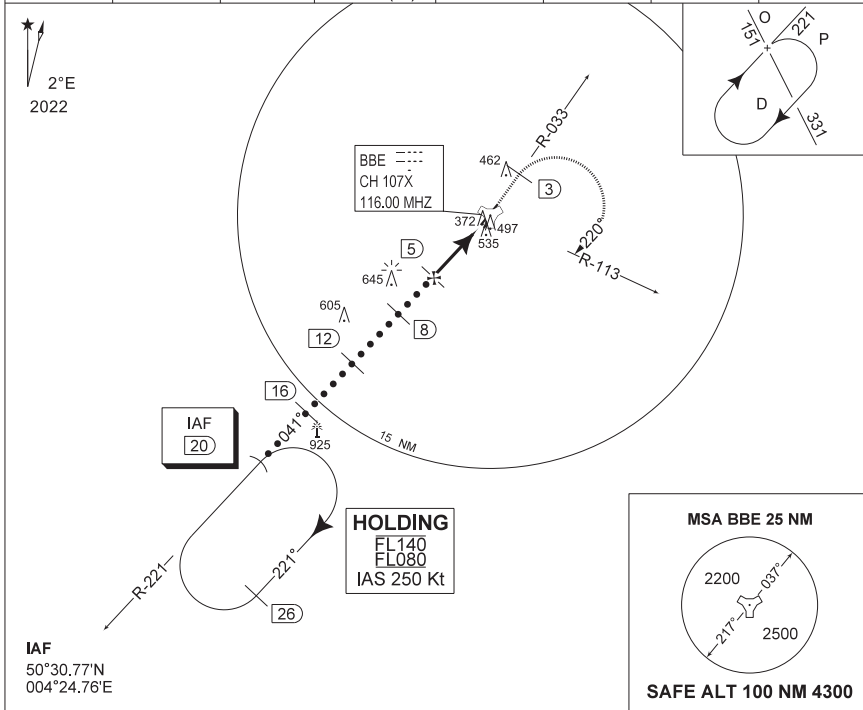

DME BBE	5	4	3	2
Altitude	1790	1470	1150	830
Height	(1441)	(1121)	(801)	(481)

TA 4500

MISSED APPROACH

Climb to 1000 FT RWY track and intercept R-033. At 2 DME past TACAN climb to 3000 FT. Passing 1500 FT or 3 DME whichever comes the latest, turn right track 220° at MAX 300 KIAS to intercept R-113 towards IAF TACAN z RWY 04L.

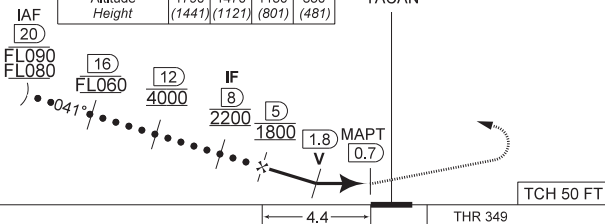

CATI	<input type="checkbox"/>	4.4	THR 349
------	--------------------------	-----	---------

CATEGORY	HPMA
S-TAC 04L	770 - 1.3 421 (500 - 1.3 / 2.2)

CHANGE: Editorial

HPMA TACAN RWY 04L

50°45.47' N
004°46.02' E

BEAUVECHAIN (EBBE)

BEL DEFENSE. AIR COMPONENT 16-APR-2026 -THS

MIPS
INSTRUMENT APPROACH CHART

AD ELEV 362

TACAN z RWY 04L
BEAUVECHAIN (EBBE)

BELGA RADAR 374.400 129.325		BEAUVECHAIN APP 282.100 122.830		BEAUVECHAIN TWR 362.025 130.730		BEAUVECHAIN GND 359.825 121.855	
TACAN BBE CH107X	APP COURSE 041°	FAF ALT 1800 FT	DESCENT GR 5.24%(3°)	MDA 770	THR 349 FT	ALS 930 M	LDA 7959 FT

NOTE:

a) HOLDING AT 4000 FT UNDER RADAR CONTROL MANDATORY

2°E
2022

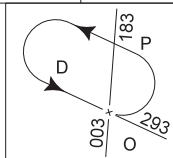

IAF
50°42.03'N
004°57.53'E
HOLDING
4000
3000
IAS 250 Kt

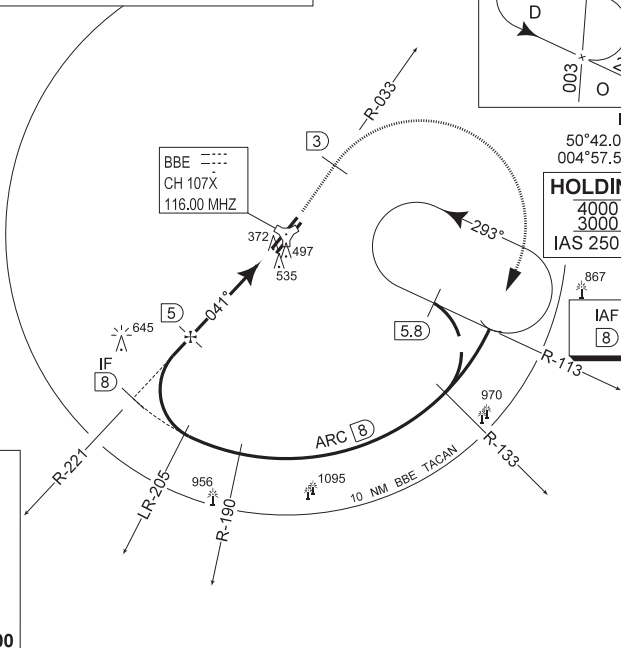

MSA BBE 25 NM

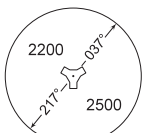

SAFE ALT 100 NM 4300

DME BBE	5	4	3	2
Altitude	1790	1470	1150	830
Height	(1441)	(1121)	(801)	(481)

MISSED APPROACH

Climb to 1000 FT RWY track and intercept R-033. At 2 DME past TACAN climb to 3000 FT. Passing 1500 FT or 3 DME whichever comes the latest, turn right at MAX 250 KIAS (MAX 300 KIAS for HPMA) to intercept R-113 towards IAF.

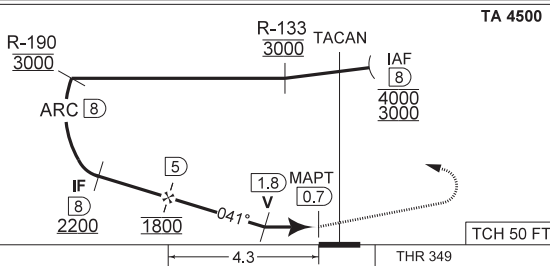

TA 4500

CAT I

CATEGORY	A	B	C	D	HPMA
S-TAC 04L			770 - 1.3 421 (500 - 1.3 / 2.2)		

CHANGE: Editorial

TACAN z RWY 04L

50°45.47' N
004°46.02' E

BEAUVECHAIN (EBBE)

BELDEFENSE. AIR COMPONENT 16-APR-2026 -THS

MIPS
INSTRUMENT APPROACH CHART

AD ELEV 362

ILS z or LOC z RWY 22R
BEAUVECHAIN (EBBE)

BELGA RADAR 374.400 129.325		BEAUVECHAIN APP 282.100 122.830		BEAUVECHAIN TWR 362.025 130.730		BEAUVECHAIN GND 359.825 121.855	
LOC / DME IBBE 111.350 / 107X		APP COURSE 217°	GS INTCP ALT 1900 FT	GS 3.00°	DA 515	THR 315 FT	ALS LDA 930 M 7988 FT



IAF
50°46.09'N
004°49.08'E

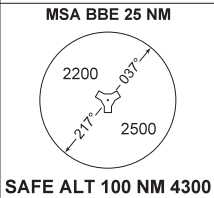
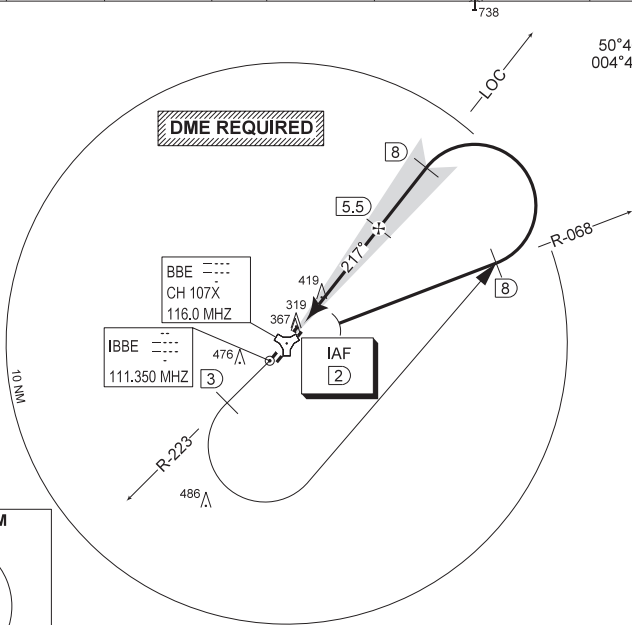

DME BBE	5	4	3	2
Altitude	1760	1440	1120	800
Height	(1444)	(1124)	(804)	(484)

MISSED APPROACH
Climb to 1000 FT runway track and intercept R-223. At 2 DME passed TACAN climb to 3000 FT. Passing 3 DME, turn left at MAX 220 KIAS (300 KIAS for HPMA) to intercept 8 DME/R-068 outbound and proceed for a ILS z or LOC z RWY 22R.

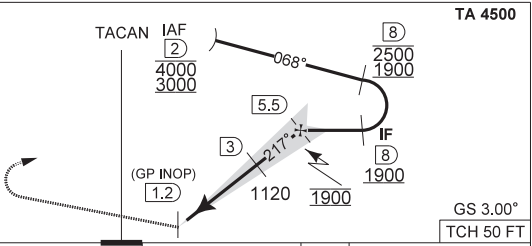

CAT I	<input checked="" type="checkbox"/>	THR 315	4.8	GS 3.00°	TCH 50 FT
-------	-------------------------------------	---------	-----	----------	-----------

CATEGORY	C	D	HPMA
S-ILS 22R	515 - 0.8 200 (200 - 0.8 / 0.9) GS 3.00°		
S-LOC 22R	720 - 1.2 405 (500 - 1.2 / 2.1)		

ILS z or LOC z RWY 22R

50°45.47' N
004°46.02' E

BEAUVECHAIN (EBBE)

CHANGE: Editorial

BEL DEFENCE. AIR COMPONENT 16-APR-2026 - THS

MIPS
INSTRUMENT APPROACH CHART

AD ELEV 362

TACAN z RWY 22R
BEAUVECHAIN (EBBE)

BELGA RADAR 374.400 129.325		BEAUVECHAIN APP 282.100 122.830		BEAUVECHAIN TWR 362.025 130.730		BEAUVECHAIN GND 359.825 121.855	
TACAN BBE CH107X	APP COURSE 213°	FAF ALT 1900 FT	DESCENT GR 5.24%(3°)	MDA 710	THR 315 FT	ALS 930 M	LDA 7988 FT

738

IAF
50°46.19'N
004°49.02'E

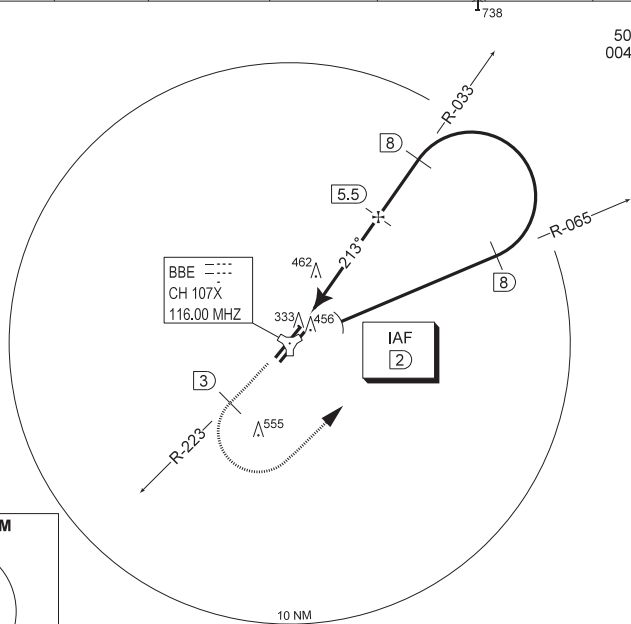

MSA BBE 25 NM

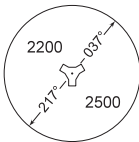

SAFE ALT 100 NM 4300

DME BBE	5	4	3	2
Altitude	1760	1440	1120	800
Height	(1444)	(1124)	(804)	(484)

TA 4500

MISSED APPROACH

Climb to 1000 FT runway track and intercept R-223. At 2 DME past TACAN climb to 3000 FT. Passing 3 DME, turn left at MAX 220 KIAS (300 KIAS for HPMA) to intercept 8 DME/R-065 outbound and proceed for a TACAN z / ILS z RWY 22R.

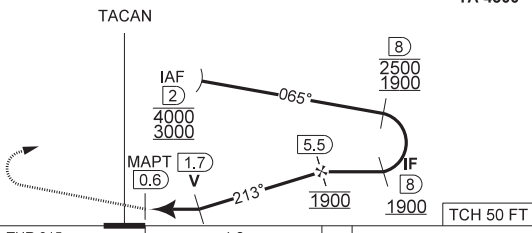

TCH 50 FT



CATEGORY	C	D	HPMA
S-TAC 22R	710 - 1.1 395 (400 - 1.1 / 2.1)		

CHANGE: Editorial

TACAN z RWY 22R

50°45.47' N
004°46.02' E

BEAUVECHAIN (EBBE)

BEL DEFENCE. AIR COMPONENT 16-APR-2026 - THS

MIPS
STANDARD ARRIVAL CHART

HPMA STAR TACAN RWY 22R
BEAUVECHAIN (EBBE)

AD ELEV 362

BELGA RADAR 374.400 129.325			BEAUVECHAIN APP 282.100 122.830			BEAUVECHAIN TWR 362.025 130.730		
TACAN	-	-	-	-	THR	ALS	LDA	
BBE CH107X	-	-	-	-	315 FT	930 M	7988 FT	

NOTE:
a) STAR ONLY AUTHORIZED FOR HPMA
TO JOIN IAF OF ILS z RWY 22R OR
TAC z RWY 22R

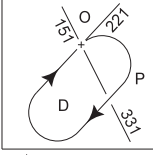

BBE ---
CH 107X
116.00 MHz
300

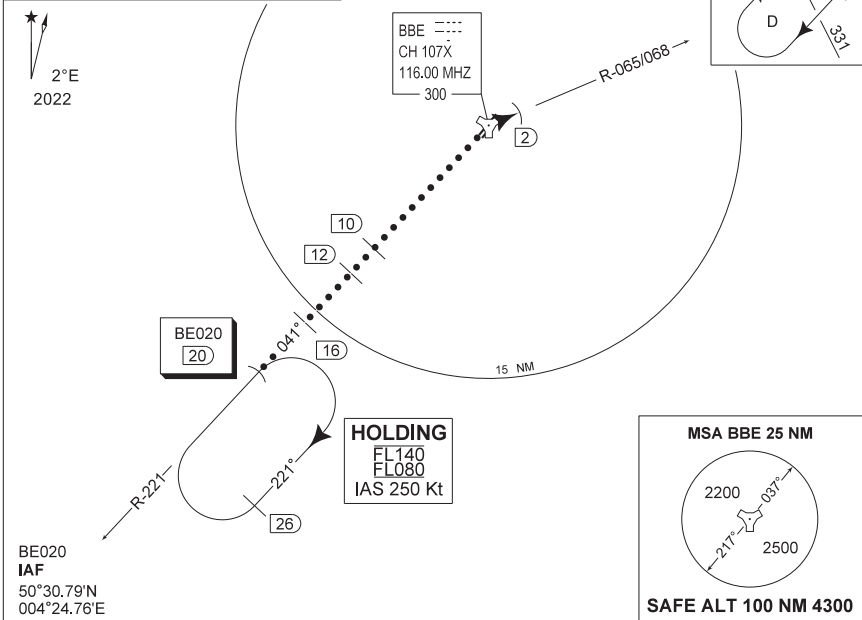

BE020
IAF
50°30.79'N
004°24.76'E

HOLDING
FL140
FL080
IAS 250 Kt

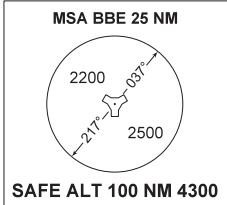

STAR DESCRIPTION
Proceed to BE020 for holding.
When cleared by ATC, proceed
inbound BBE following profile view.
When OVH, turn right to intercept
R-065 to join TAC z RWY 22R
or
R-068 to join ILS z RWY 22R

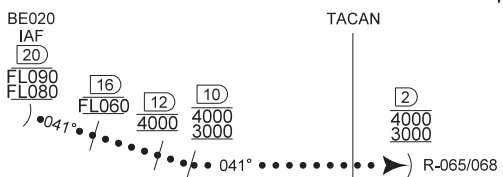

CATEGORY	HPMA
S-ILS 22R	SEE APPROACH CHART
S-LOC 22R S-TAC 22R	SEE APPROACH CHART

CHANGES: Editorial

BEL DEFENCE, AIR COMPONENT 16-APR-2028 - THS

HPMA STAR TACAN RWY 22R

50°45,47' N
004°46,02' E

BEAUVECHAIN (EBBE)

AERODROME CHART

BILLUND (EKBI)

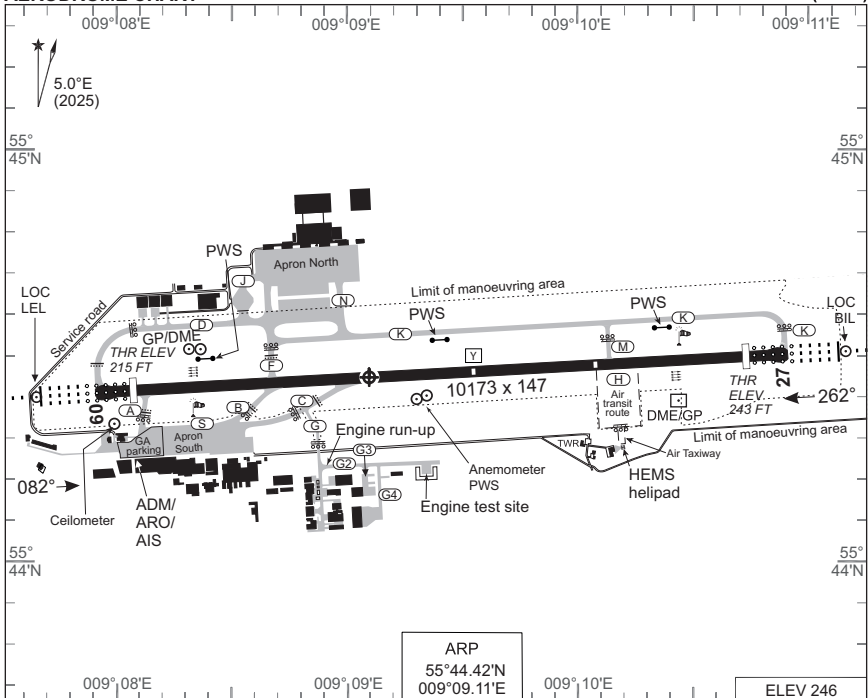

ARP
55°44.42'N
009°09.11'E

ELEV 246

RWY	PCN	DECLARED DISTANCES					THR ELEV	RWY LIGHTING					END	THR PSN
		PSN	TORA	TODA	ASDA	LDA		THR	PAPI	TDZ	CL	EDGE		
09	110 F/A/X/T	D	10173	10173	10173	9681	215	LIH Green	3°	LIH White	7200 ft White	500 ft Red	LIH Red	55°44.39'N 009°08.09'E
		A	9471	9471	9471									
		B	7709	7709	7709									
		F	7621	7621	7621									
		C	6669	6669	6669									
27	110 F/A/X/T	K	9681	9681	10173	9681	243	LIH Green	3°	LIH White	2000 ft Red/white	7700 ft White	LIH Red	55°44.47'N 009°10.76'E
		O/R	10173	10173										
		M	7126	7126	7618									
		Y	5088	5088	5580									
		C	3438	3438	3930									
B	2273	2273	2765											

TOWER (ARR / DEP) 119.005 / 129.505

ATIS (ARR / DEP) 118.780 / 129.105

Climb out for flights not cleared via an SID (MAX IAS 250 KT FL 60 and below):

RWY 09: For jet aeroplanes irrespective of weight and for propeller and turbo-propeller aeroplanes with MTOM above 5700kg: Climb on track 082° MAG to INLIS or 1000 FT MSL whichever is later, then turn according to clearance. Minimum climb gradient 3.7% until passing 1000 FT.

RWY 09: For propeller and turbo propeller aeroplanes with MTOM 5700kg or less: Climb on track 082° MAG to 1000 FT MSL, then turn according to clearance. Minimum climb gradient 3.7% until passing 1000 FT MSL.

RWY 27: All aeroplanes: Climb on track 262° MAG to DME LEL 1.0 NM or 700 FT MSL, whichever is later, then turn according to clearance.

	PROC. CRITERIA	RWY	GS	TCH	OTCH	RPI	CAT	MINIMA CRITERIA	MINIMA
PAR	INTENTIONALLY LEFT BLANK								
SRA	INTENTIONALLY LEFT BLANK								

AERODROME CHART

BILLUND (EKBI)

CHANGES: ELEV, RWY 27 THR ELEV AND LONGITUDE, VAR AND DIRECTIONS CHANGED.

AIR COMMAND DENMARK - MIL AIM 19 FEB 2026

COPENHAGEN CONTROL 362.750 136.550		BILLUND ATIS (ARR / DEP) 118.780 129.105		BILLUND APPROACH 127.580			BILLUND TOWER (ARR / DEP) 119.005 129.505	
LOC / DME BIL 109.750 / CH 34y		APP COURSE 082°	GS INTCP ALT 2000 FT	GS 3.00°	DA 415	THR ELEV 215	ALS LENGTH 900 M	LDA 9681 FT

RNAV 1 REQUIRED 
DME REQUIRED

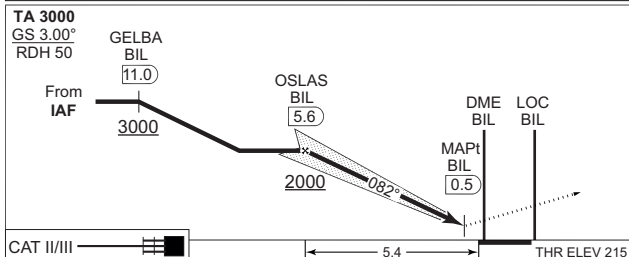
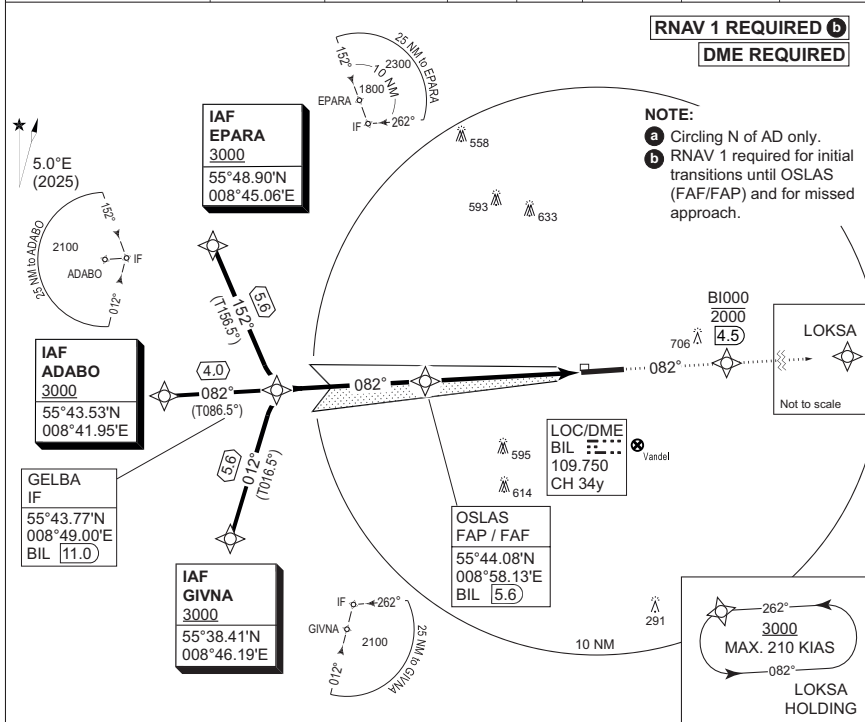

CDFA: GS 3.00° / 5.24% / 318 ft/NM

DME BIL	5	4	3	2	1
DIST THR	4.85	3.85	2.85	1.85	0.85
ALT	1810	1490	1180	860	540

MISSED APPROACH
Climb straight ahead to 2000 FT. After passing B1000 continue climb to 3000 FT to LOKSA and join the holding.

CATEGORY	A		B		C		D		E	
S-ILS CAT I			415 - 550 200 (200-0.8/1.2)						475 - 600 260 (300-0.8/1.3)	
S-ILS CAT II			RA 102 (DA 315) - 350 100						N/A	
S-LOC 09			640 - 1300 425 (500-1.3/2.0)							
CIRCLING 	800	- 1.5 553 (600-1.5)	820	- 1.6 573 (600-1.6)	1100	- 2.4 853 (900-2.4)	1100	- 3.6 853 (900-3.6)	1200	- 3.6 953 (1000-3.6)

COPENHAGEN CONTROL 362.750 136.550		BILLUND ATIS (ARR / DEP) 118.780 129.105		BILLUND APPROACH 127.580		BILLUND TOWER (ARR / DEP) 119.005 129.505	
LOC BIL 109.750	DME LEL 110.700/CH 44x	APP COURSE 082°	GS INTCP ALT 2000 FT	GS 3.00°	DA 415	THR ELEV 215	ALS LENGTH 900 M LDA 9681 FT

RNAV 1 REQUIRED
DME REQUIRED

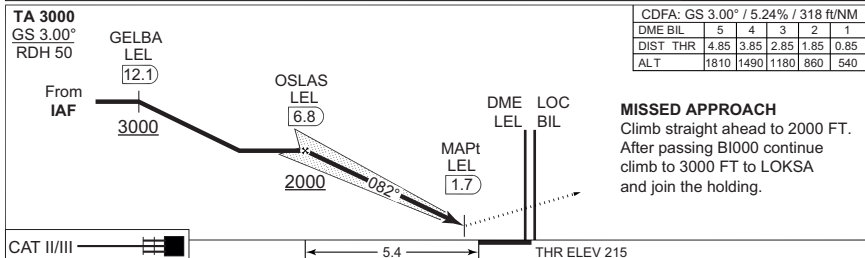
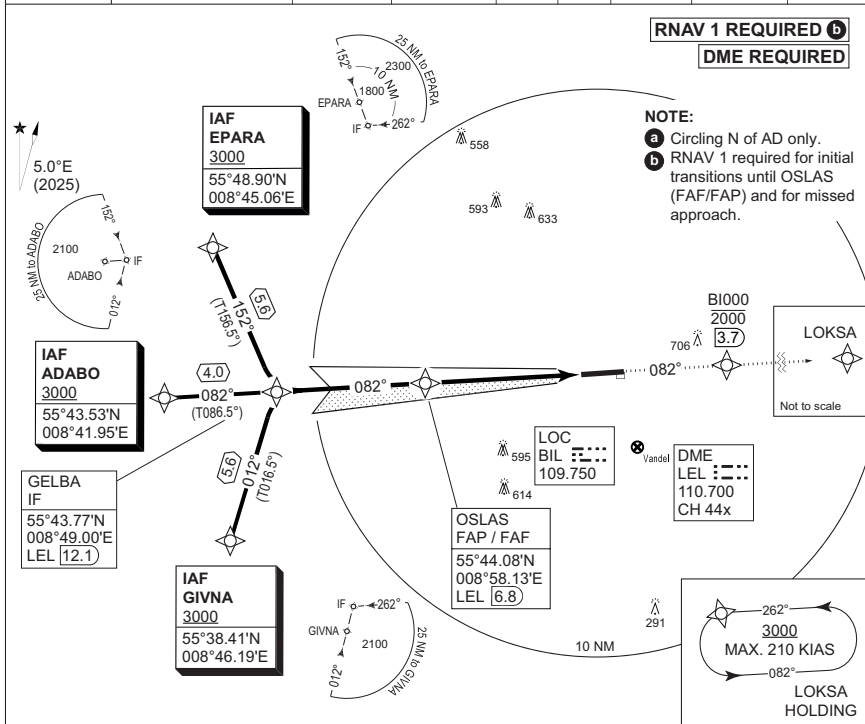

CDFA: GS 3.00° / 5.24% / 318 ft/NM					
DME BIL	5	4	3	2	1
DIST	4.85	3.85	2.85	1.85	0.85
ALT	1810	1490	1180	860	540

CHANGES: EDITORIAL

CATEGORY	A	B	C	D	E
S-ILS CAT I		415 - 550 200 (200-0.8/1.2)			475 - 600 260 (300-0.8/1.3)
S-ILS CAT II		RA 102 (DA 315) - 350 100			N/A
S-LOC 09		640 - 1300 425 (500-1.3/2.0)			
CIRCLING a	800 - 1.5 553 (600-1.5)	820 - 1.6 573 (600-1.6)	1100 - 2.4 853 (900-2.4)	1100 - 3.6 853 (900-3.6)	1200 - 3.6 953 (1000-3.6)

MIPS
INSTRUMENT APPROACH CHART

RNP RWY 09
BILLUND (EKBI)

AD ELEV 246

COPENHAGEN CONTROL 362.750 136.550	BILLUND ATIS (ARR / DEP) 118.780 129.105	BILLUND APPROACH 127.580	BILLUND TOWER (ARR / DEP) 119.005 129.505
EGNOS CHANNEL 57711 / E09A	APP COURSE 082°	FAF ALT 2000 FT	DESCENT GR 3.0° (5.2%)
		DA See CAT	THR ELEV 215
		ALS LENGTH 900 M	LDA 9681 FT

RNP APCH

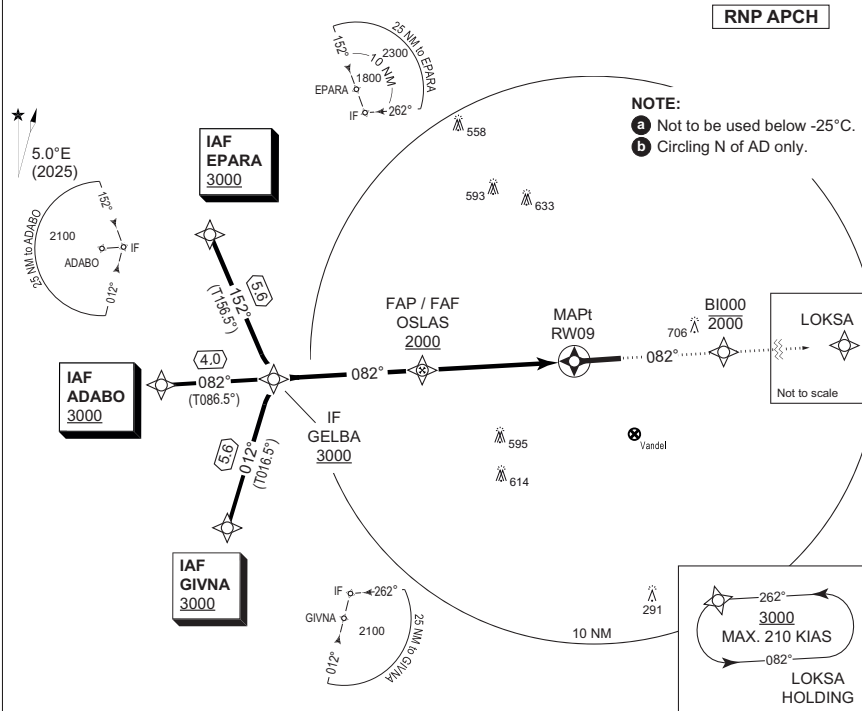

TA 3000
RDH 50

CDFA: GS 3.00° / 5.24%				
DIST THR	5	4	3	2
ALT	1860	1540	1220	900

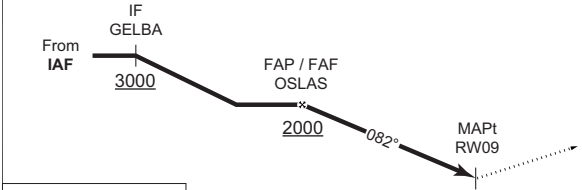

MISSED APPROACH
Climb straight ahead to 2000 FT.
After passing BI000 continue
climb to 3000 FT to LOKSA
and join the holding.

CAT II/III

5.4 THR ELEV 215

CATEGORY	A	B	C	D	E
S-LPV	465 - 600 250 (300-0.8/1.2)				
S-LNAV/VNAV a	530 - 700 315 (400-0.7/1.4)	540 - 800 325 (400-0.8/1.5)	550 - 800 335 (400-0.8/1.5)	560 - 900 345 (400-0.9/1.6)	570 - 900 355 (400-0.9/1.6)
S-LNAV	640 - 1300 425 (500-1.3/2.0)				
CIRCLING b	800 - 1.5 553 (600-1.5)	820 - 1.6 573 (600-1.6)	1100 - 2.4 853 (900-2.4)	1100 - 3.6 853 (900-3.6)	1200 - 3.6 953 (1000-3.6)

RNP RWY 09

55°44.42'N
009°09.11'E

BILLUND (EKBI)

CHANGES: EDITORIAL

AIR COMMAND DENMARK - MIL AIM 16 APR 2026

EKBI RNP RWY 09 waypoint coordinates:

RWY 09 from EPARA (Initial LEFT) APPROACH RNP

		CODING			DISPLAY	
EPARA	IAF	55 48 53.73N	008 45 03.66E	55 48.895N	008 45.061E	
GELBA	IF	55 43 46.09N	008 49 00.40E	55 43.767N	008 49.000E	
OSLAS	FAP/FAF	55 44 04.88N	008 58 27.93E	55 44.081N	008 58.132E	
RW09	MAPt	55 44 23.24N	009 08 05.34E	55 44.387N	009 08.089E	
BI000	MATF	55 44 40.12N	009 16 55.26E	55 44.669N	009 16.921E	
LOKSA	MAHF	55 45 03.55N	009 30 47.65E	55 45.059N	009 30.794E	

RWY 09 from ADABO (Initial CENTRE) APPROACH RNP

		CODING			DISPLAY	
ADABO	IAF	55 43 31.58N	008 41 56.73E	55 43.526N	008 41.946E	
GELBA	IF	55 43 46.09N	008 49 00.40E	55 43.767N	008 49.000E	
OSLAS	FAP/FAF	55 44 04.88N	008 58 27.93E	55 44.081N	008 58.132E	
RW09	MAPt	55 44 23.24N	009 08 05.34E	55 44.387N	009 08.089E	
BI000	MATF	55 44 40.12N	009 16 55.26E	55 44.669N	009 16.921E	
LOKSA	MAHF	55 45 03.55N	009 30 47.65E	55 45.059N	009 30.794E	

RWY 09 from GIVNA (Initial RIGHT) APPROACH RNP

		CODING			DISPLAY	
GIVNA	IAF	55 38 24.65N	008 46 11.24E	55 38.411N	008 46.187E	
GELBA	IF	55 43 46.09N	008 49 00.40E	55 43.767N	008 49.000E	
OSLAS	FAP/FAF	55 44 04.88N	008 58 27.93E	55 44.081N	008 58.132E	
RW09	MAPt	55 44 23.24N	009 08 05.34E	55 44.387N	009 08.089E	
BI000	MATF	55 44 40.12N	009 16 55.26E	55 44.669N	009 16.921E	
LOKSA	MAHF	55 45 03.55N	009 30 47.65E	55 45.059N	009 30.794E	

Threshold coordinates RWY 09

		CODING			DISPLAY	
RWY 09		55 44 23.24N	009 08 05.34E	55 44.387N	009 08.089E	

MIPS

INSTRUMENT APPROACH CHART

AD ELEV 246

**ILS Z or LOC Z RWY 27
BILLUND (EKB)**

COPENHAGEN CONTROL 362.750 136.550	BILLUND ATIS (ARR / DEP) 118.780 129.105	BILLUND APPROACH 127.580	BILLUND TOWER (ARR / DEP) 119.005 129.505
LOC / DME LEL 110.700 / CH 44x	APP COURSE 262°	GS INTCP ALT 2000 FT	GS 3.00°
		DA SEE CAT	THR ELEV 243
			ALS LENGTH 900 M
			LDA 9681 FT

NOTE:

- a** Circling N of AD only.
- b** Max. 195 KIAS. Direct entry only.
- c** RNAV 1 required for initial transitions until ELRIT (FAF/FAP) and for missed approach.

RNAV 1 REQUIRED
DME REQUIRED

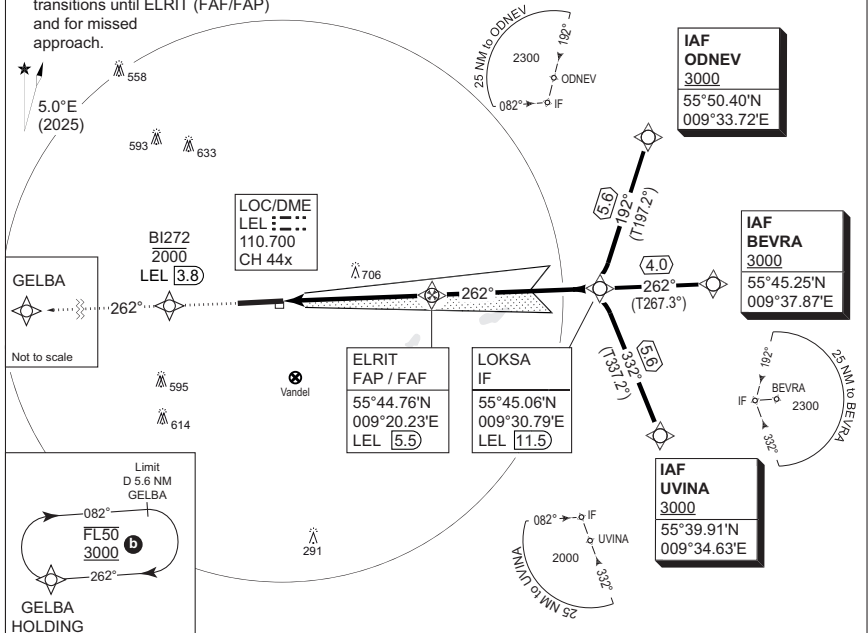

CDFA: GS 3.00° / 5.24%					
DME LEL	2	3	4	5	
DIST THR	1.8	2.8	3.8	4.8	
ALT	870	1190	1510	1830	

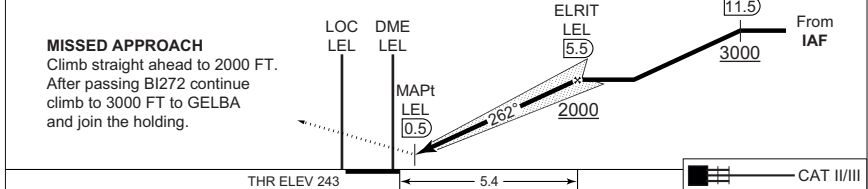

	THR ELEV 243		5.4		CAT II/III	
CATEGORY	A	B	C	D	E	
S-ILS CAT I		444	- 550 200 (200-0.8/1.2)		479	- 550 235 (300-0.8/1.2)
S-ILS CAT II		RA 93	(DA 344) - 350 100		N/A	
S-LOC 27		750	- 1600 503 (600-1.6/2.4)			
CIRCLING a	800	- 1.5 553 (600-1.5)	820	- 1.6 573 (600-1.6)	1100	- 2.4 853 (900-2.4)
					1100	- 3.6 853 (900-3.6)
					1200	- 3.6 953 (1000-3.6)

ILS Z or LOC Z RWY 27

55°44.42'N
009°09.11'E

BILLUND (EKB)

CHANGES: EDITORIAL

AIR COMMAND DENMARK - MIL-AIM 16 APR 2025

MIPS

INSTRUMENT APPROACH CHART

AD ELEV 246

**ILS Y or LOC Y RWY 27
BILLUND (EKB)**

COPENHAGEN CONTROL 362.750 136.550		BILLUND ATIS (ARR / DEP) 118.780 129.105		BILLUND APPROACH 127.580		BILLUND TOWER (ARR / DEP) 119.005 129.505		
LOC LEL 110.700	DME BIL 109.750/CH 34y	APP COURSE 262°	GS INTCP ALT 2000 FT	GS 3.00°	DA SEE CAT	THR ELEV 243	ALS LENGTH 900 M	LDA 9681 FT

NOTE:

- a** Circling N of AD only.
- b** Max. 195 KIAS. Direct entry only.
- c** RNAV 1 required for initial transitions until ELRIT (FAF/FAP) and for missed approach.

RNAV 1 REQUIRED
DME REQUIRED

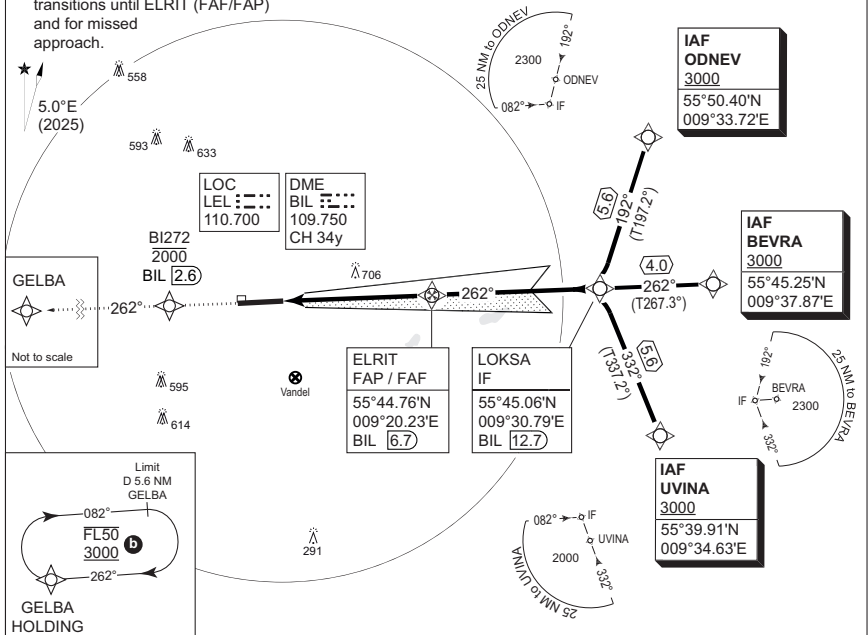

CDFA: GS 3.00° / 5.24%				
DME BIL	3	4	5	6
DIST THR	1.6	2.6	3.6	4.6
ALT	815	1130	1450	1770

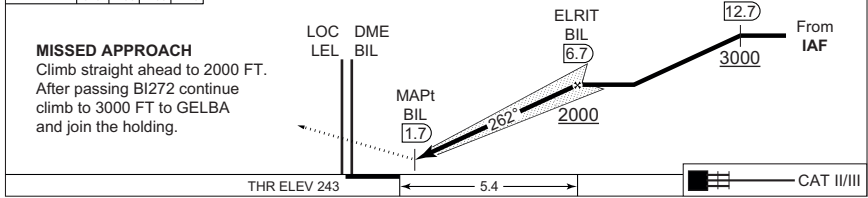

CATEGORY	A	B	C	D	E
S-ILS CAT I		444 - 550 200 (200-0.8/1.2)			479 - 550 235 (300-0.8/1.2)
S-ILS CAT II		RA 93 (DA 344) - 350 100			N/A
S-LOC 27		750 - 1600 503 (600-1.6/2.4)			
CIRCLING a	800 - 1.5 553 (600-1.5)	820 - 1.6 573 (600-1.6)	1100 - 2.4 853 (900-2.4)	1100 - 3.6 853 (900-3.6)	1200 - 3.6 953 (1000-3.6)

ILS Y or LOC Y RWY 27

55°44.42'N
009°09.11'E

BILLUND (EKB)

CHANGES: EDITORIAL

AIR COMMAND DENMARK - MIL_AIM_16_APR_2025

COPENHAGEN CONTROL 362.750 136.550	BILLUND ATIS (ARR / DEP) 118.780 129.105	BILLUND APPROACH 127.580	BILLUND TOWER (ARR / DEP) 119.005 129.505
EGNOS CHANNEL 65547 / E27A	APP COURSE 262°	GS INTCP ALT 2000 FT	GS 3.00°
		DA	THR ELEV 243
		SEE CAT	ALS LENGTH 900 M
			LDA 9681 FT

NOTE:

- a Circling N of AD only.
- b) RNP 1 required for initial and missed approach.
- c Max. 195 KIAS. Direct entry only.
- d Not to be used below -25°C.

RNP APCH

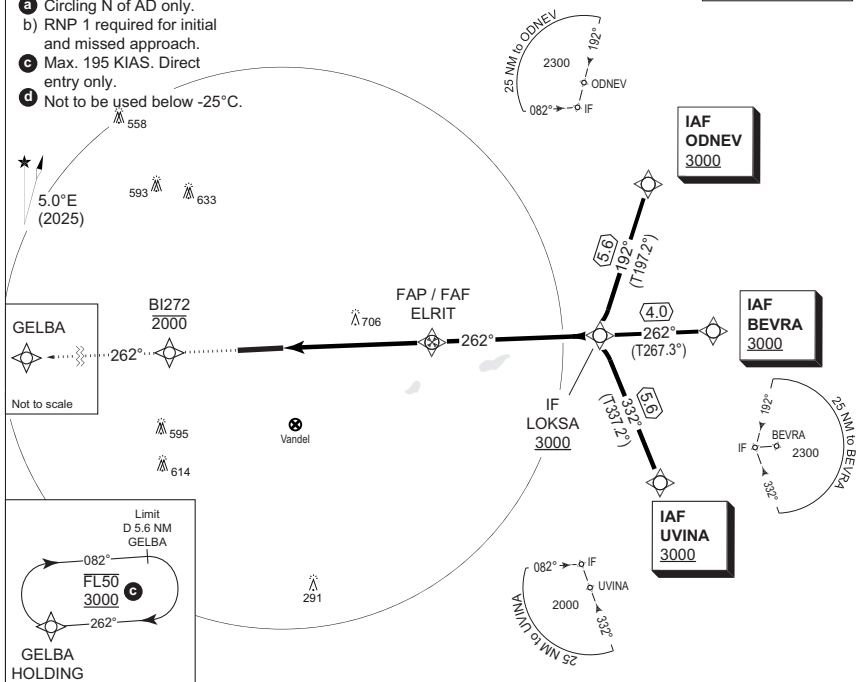

CDFA: GS 3.00° / 5.24%					
DIST THR	2	3	4	5	
ALT	930	1250	1570	1890	

TA 3000
GS 3.00°
RDH 49

MISSED APPROACH

Climb straight ahead to 2000 FT.
After passing BI272 continue climb to 3000 FT to GELBA and join the holding.

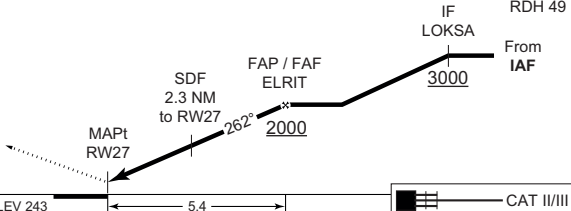

CHANGES: EDITORIAL

CATEGORY	A	B	C	D	E
S-LPV	494 - 600 250 (300-0.8/1.2)				
S-LNAV/VNAV ^d	630 - 1100 386 (400-1.1/1.8)	640 - 1100 396 (400-1.1/1.8)	650 - 1200 406 (500-1.2/1.9)	660 - 1200 416 (500-1.2/1.9)	680 - 1300 436 (500-1.3/2.0)
S-LNAV	740 - 1500 493 (500-1.5/2.3)				
CIRCLING ^a	800 - 1.5 553 (600-1.5)	820 - 1.6 573 (600-1.6)	1100 - 2.4 853 (900-2.4)	1100 - 3.6 853 (900-3.6)	1200 - 3.6 953 (1000-3.6)

EKBI RNP RWY 27 waypoint coordinates:

RWY 27 from UVINA (Initial LEFT) APPROACH RNP

		CODING			DISPLAY		
UVINA	IAF	55 39	54.46N	009 34	38.00E	55 39.908N	009 34.633E
LOKSA	IF	55 45	03.55N	009 30	47.65E	55 45.059N	009 30.794E
ELRIT	FAP/FAF	55 44	45.31N	009 20	13.52E	55 44.755N	009 20.225E
RW27	MAPt	55 44	28.20N	009 10	45.60E	55 44.470N	009 10.760E
BI272	MATF	55 44	14.95N	009 03	41.67E	55 44.249N	009 03.693E
GELBA	MAHF	55 43	46.09N	008 49	00.40E	55 43.767N	008 49.000E

RWY 27 from BEVRA (Initial CENTRE) APPROACH RNP

		CODING			DISPLAY		
BEVRA	IAF	55 45	15.24N	009 37	51.87E	55 45.254N	009 37.865E
LOKSA	IF	55 45	03.55N	009 30	47.65E	55 45.059N	009 30.794E
ELRIT	FAP/FAF	55 44	45.31N	009 20	13.52E	55 44.755N	009 20.225E
RW27	MAPt	55 44	28.20N	009 10	45.60E	55 44.470N	009 10.760E
BI272	MATF	55 44	14.95N	009 03	41.67E	55 44.249N	009 03.693E
GELBA	MAHF	55 43	46.09N	008 49	00.40E	55 43.767N	008 49.000E

RWY 27 from ODNEV (Initial RIGHT) APPROACH RNP

		CODING			DISPLAY		
ODNEV	IAF	55 50	23.93N	009 33	43.41E	55 50.399N	009 33.724E
LOKSA	IF	55 45	03.55N	009 30	47.65E	55 45.059N	009 30.794E
ELRIT	FAP/FAF	55 44	45.31N	009 20	13.52E	55 44.755N	009 20.225E
RW27	MAPt	55 44	28.20N	009 10	45.60E	55 44.470N	009 10.760E
BI272	MATF	55 44	14.95N	009 03	41.67E	55 44.249N	009 03.693E
GELBA	MAHF	55 43	46.09N	008 49	00.40E	55 43.767N	008 49.000E

Threshold coordinates RWY 27

		CODING			DISPLAY		
RWY 27		55 44	28.20N	009 10	45.60E	55 44.470N	009 10.760E

MIPS

AERODROME CHART

BODOE(ENBO)

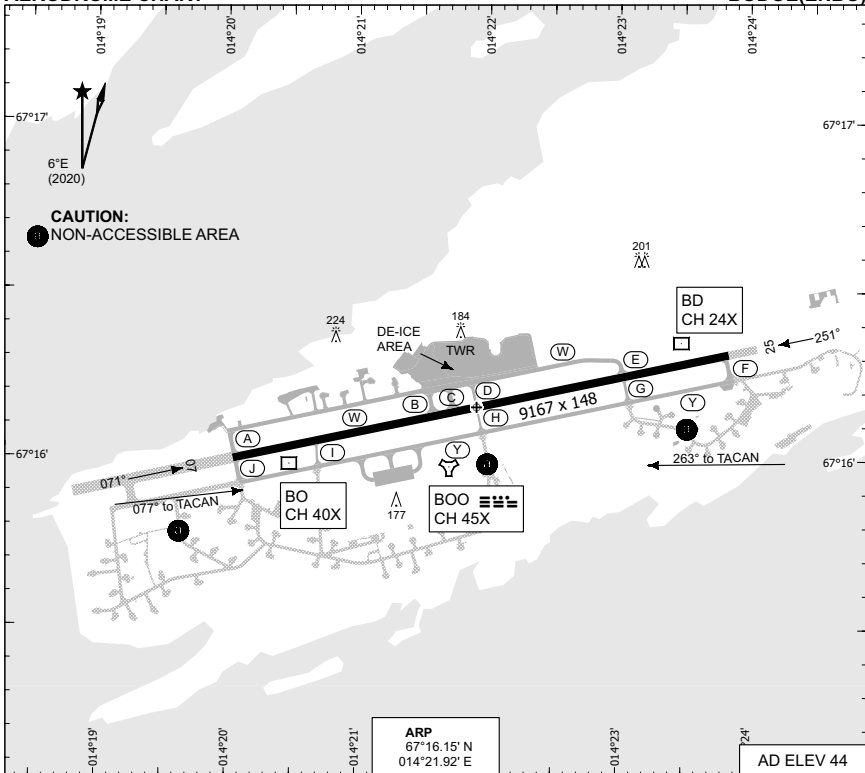

RWY	PCN	TORA	ASDA	TODA	LDA	PAPI	THR ELEV	THR PSN
07	65/R/B/X/U	9167	9167	10049	9167	3.0°	19	67°16.00' N - 014°20.05' E
25	65/R/B/X/U	9167	9167	9167	9167	3.5°	41	67°16.31' N - 014°23.84' E

ATIS 123.900
DE-ICE 121.955 131.750
BODØ TWR 118.100 398.650

PROC. CRITERIA	RWY	GS	TCH	OTCH	RPI	CAT	MINIMA CRITERIA	MINIMA

CHANGE PERIODIC REVIEW

RNOGAF 30 OCT 2025

AERODROME CHART

BODOE(ENBO)

**MIPS
INSTRUMENT DEPARTURE CHART**

**HPMA SALTY / HPMA BITNO DEP
BODOE (ENBO)**

AD ELEV 43

ATIS 123.900	BODOE GND 121.750 358.475	BODOE TWR 118.100 398.650	BODOE DEP 119.700 277.300
-----------------	------------------------------	------------------------------	------------------------------

POLARIS CONTROL N 126.455 N 278.050 S 118.555 S 240.575	
--	--

NOTE:

- a) CLOSE IN OBSTACLE
550 M EAST OF DEPARTURE
END RWY 07 (LIGHTED
MAST 151 FT).

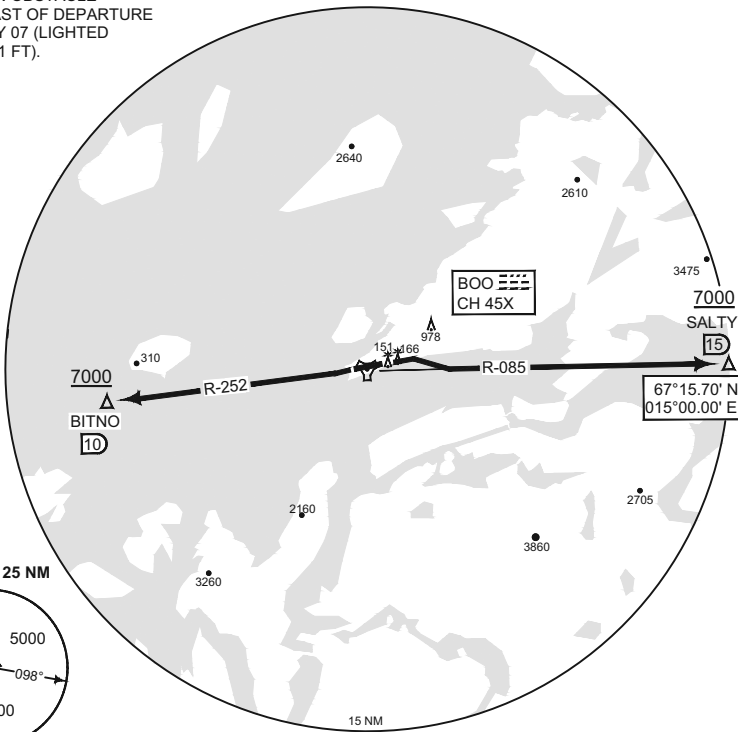

MSA BOO 25 NM

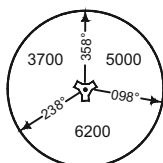

SAFE ALT 100 NM 9200 **TA 7000**

HPMA SALTY (RWY 07)	<ul style="list-style-type: none"> - Climb on track 072°. - Passing 500 ft, turn right to intercept BOO R-085 outbound and continue climb to 7000 ft. - Proceed to SALTY.
------------------------	--

HPMA BITNO (RWY 25)	<ul style="list-style-type: none"> - Climb outbound on R-252 to 7000 ft. - Proceed to BITNO.
------------------------	--

When instructed by Bodoie TWR, contact DEP 119.700 or 277.300

CHANGES: POLARIS CONTROL FREQUENCIES.

RND/AF 25 DEC 2025

HPMA SALTY / HPMA BITNO DEP

67°16.15' N
014°21.92' E

BODOE (ENBO)

MIPS INSTRUMENT APPROACH CHART

HPMA ILS or LOC RWY 07 BODOE (ENBO)

AD ELEV 43

ATIS 123.900	BODOE APP 119.700 124.000 277.300 259.025	BODOE TWR 118.100 398.650 257.800	BODOE GND 121.750 358.475
ILS/DME BO 110.300 / CH 40X	APP COURSE 072°	GS INTCP ALT 2000	GS 3.0° DA 246 THR ELEV 19
ALS 900 m	LDA 9166		

CAUTION:

● CIRCLING NOT AUTHORIZED NORTH OF RWY 07 / 25.

NOTE:

- b) DME REQUIRED.
- c) DME FROM BOO UNLESS INDICATED OTHERWISE.
- d) ARDUX AND STOETT MAX HOLDING SPEED 230 KIAS.

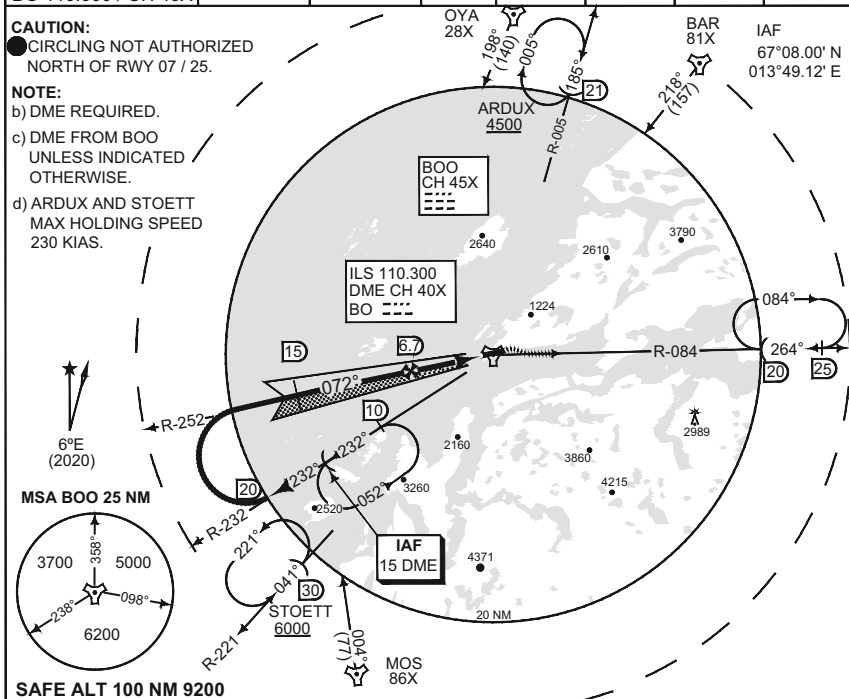

DME	6	5	4	3	2
ALT BOO	1780	1470	1150	830	510
ALT BO	1940	1620	1300	990	670

TA 7000

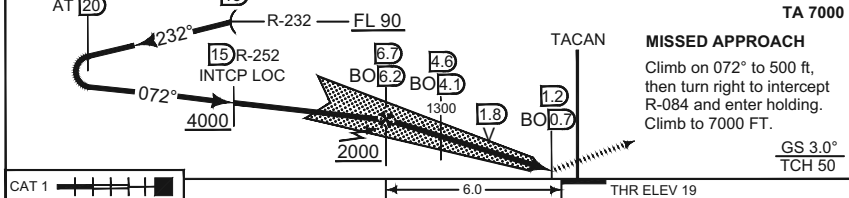

CATEGORY	HPMA
S-ILS 07	246 - 0.8 227 (300 - 0.8/1.6)
S-LOC 07	410 - 1.6 391 (400 - 1.6/2.4)
● CIRCLING	1090 - 3.2 1047 (1100 - 3.2)

HPMA ILS or LOC RWY 07 67°16.15' N **BODOE (ENBO)**
014°21.92' E

CHANGES: PAGE SIZE MIPS

RNOIAT 08 AUG 2024

MIPS INSTRUMENT APPROACH CHART

ILS M or LOC M RWY 07 BODOE (ENBO)

AD ELEV 43

ATIS 123.900	BODOE APP 119.700 124.000 277.300 259.025			BODOE TWR 118.100 398.650 257.800			BODOE GND 121.750 358.475	
ILS/DME BO 110.300 / CH 40X	APP COURSE 072°	GS INTCP ALT 2000	GS 3.0°	DA SEE CAT	THR ELEV 19	ALS 900 m	LDA 9166	

CAUTION:

● CIRCLING NOT AUTHORIZED NORTH OF RWY 07 / 25.

NOTE:

- b) DME REQUIRED.
- c) DME FROM BOO UNLESS INDICATED OTHERWISE.
- d) ARDUX AND STOETT MAX HOLDING SPEED 230 KIAS.

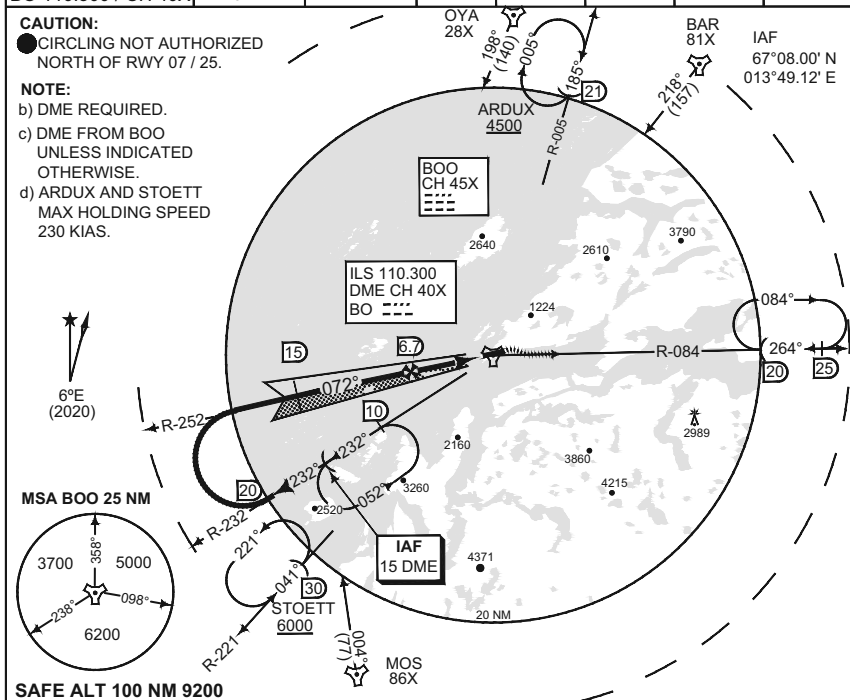

SAFE ALT 100 NM 9200

DME	6	5	4	3	2
ALT BOO	1780	1470	1150	830	510
ALT BO	1940	1620	1300	990	670

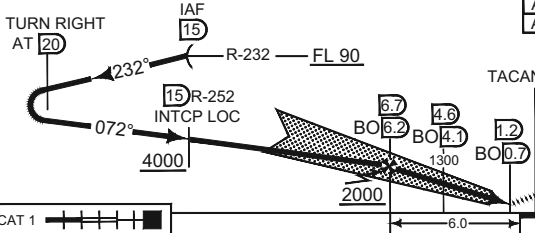

TA 7000
MISSED APPROACH
 Climb on RWY track. Passing 500 ft, turn right (MAX 185 KIAS) and intercept R-084. Climb to 7000 ft. Passing BOO 20 DME or 5300 ft whichever occurs last, turn left and enter holding.

CAT 1	6.0			THR ELEV 19
-------	-----	--	--	-------------

CATEGORY	B	C	D
S-ILS 07	380 - 1.0 361 (400 - 1.0/1.7)	390 - 1.0 371 (400 - 1.0/1.7)	400 - 1.1 381 (400 - 1.1/1.8)
S-LOC 07	410 - 1.1 391 (400 - 1.1/1.8)	410 - 1.1 391 (400 - 1.1/1.8)	410 - 1.2 391 (400 - 1.1/1.8)
● CIRCLING	1090 - 4.9 1047 (1100 - 4.9)	1300 - 5.0 1257 (1300 - 5.0)	1300 - 5.0 1257 (1300 - 5.0)

ILS M or LOC M RWY 07

67°16.15' N
014°21.92' E

BODOE (ENBO)

CHANGES: PAGE SIZE MIPS

RNOAF 08 AUG 2024

MIPS INSTRUMENT APPROACH CHART

HPMA TACAN RWY 07 BODOE (ENBO)

AD ELEV 43

ATIS 123.900	BODOE APP 119.700 124.000 277.300 259.025	BODOE TWR 118.100 398.650 257.800	BODOE GND 121.750 358.475				
TACAN BOO CH 45X	APP COURSE 077°	FAF ALT 1800	Descent GR 5.3% (3.0°)	MDA 390	THR ELEV 19	ALS 900 m	LDA 9166

CAUTION:

● CIRCLING NOT AUTHORIZED NORTH OF RWY 07 / 25.

NOTE:

- b) FINAL OFFSET 5° NORTH OF RWY CENTERLINE.
- c) ARDUX AND STOETT MAX HOLDING SPEED 230 KIAS.

IAF
67°08.00' N
013°49.12' E

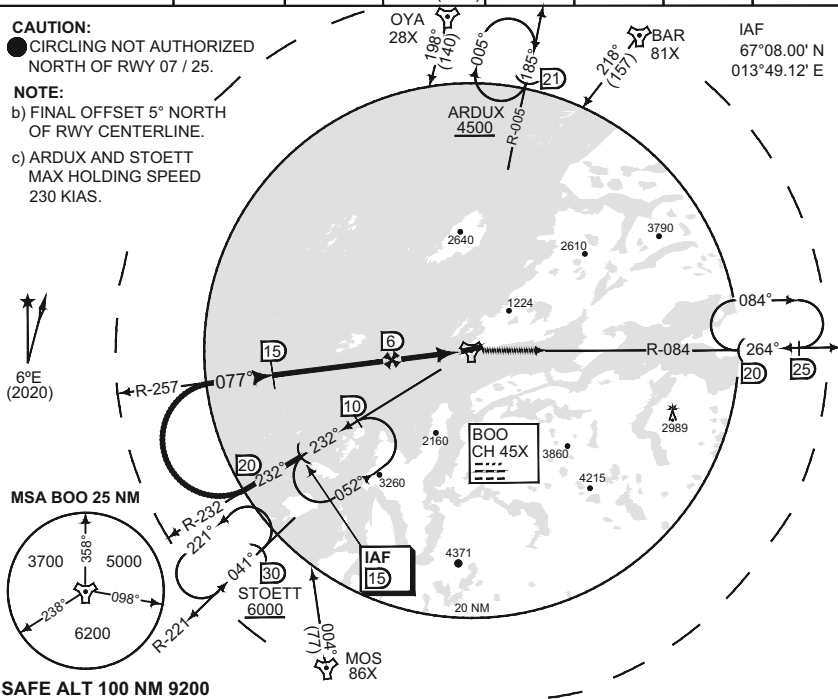

DME BOO	6	5	4	3	2
ALT	1800	1480	1160	840	510

TA 7000

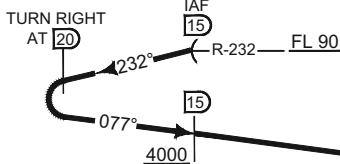

MISSED APPROACH

At 1.5 DME climb on 077° to BOO, then R-084 outbound and enter holding. Climb to 7000 FT

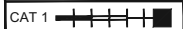

5.4 THR ELEV 19

HPMA	
S-TAC 07	390 - 1.2 371 (400-1.2/2.0)
● CIRCLING	1090 - 3.2 1047 (1100-3.2)

HPMA TACAN RWY 07

67°16.15' N
014°21.92' E

BODOE (ENBO)

CHANGES/EDITORIALS

RNOAF 25 DEC 2025

MIPS INSTRUMENT APPROACH CHART

AD ELEV 43

TACAN RWY 07 BODOE (ENBO)

ATIS 123.900	BODOE APP 119.700 124.000 277.300 259.025			BODOE TWR 118.100 398.650 257.800			BODOE GND 121.750 358.475	
TACAN BOO CH 45X	APP COURSE 077°	FAF ALT 1800	Descent GR 5.3% (3.0°)	MDA 460	THR ELEV 19	ALS 900 m	LDA 9166	

CAUTION:

● CIRCLING NOT AUTHORIZED NORTH OF RWY 07 / 25.

NOTE:

- b) FINAL OFFSET 5° NORTH OF RWY CENTERLINE.
- c) ARDUX AND STOETT MAX HOLDING SPEED 230 KIAS.

IAF
67°08.00' N
013°49.12' E

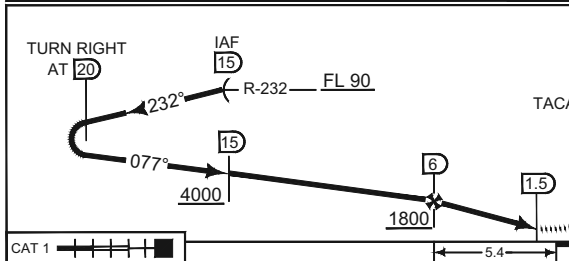
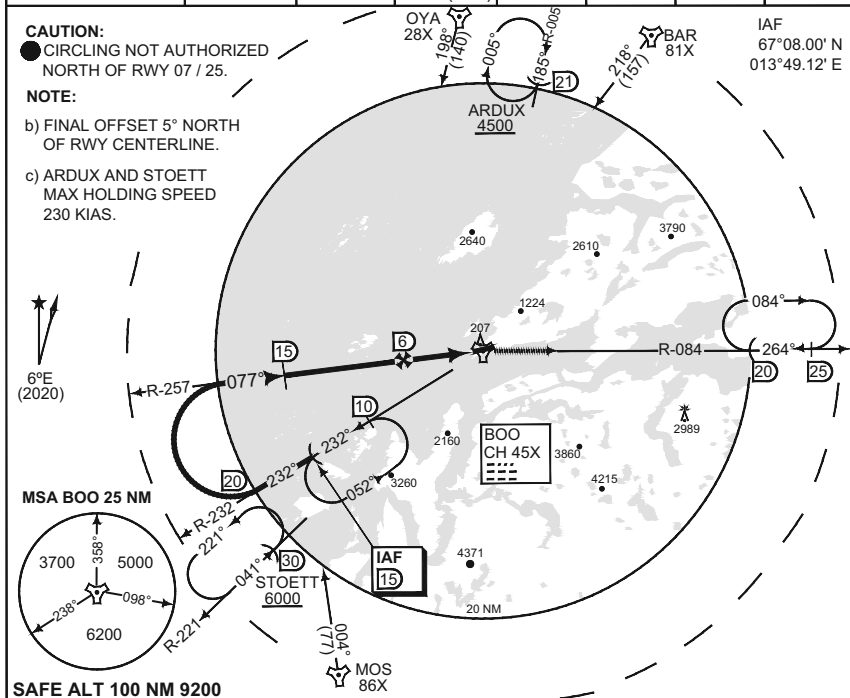

MISSED APPROACH
Climb on track 077° to BOO, then track R-084 outbound. Climb to 7000 ft. Passing BOO 20 DME or 5300 ft whichever occurs LAST, turn left and enter holding.

CATEGORY	B	C	D
S-TAC 07	460 - 0.8 441 (500-0.8/1.6)	460 - 1.2 441 (500-1.2/2.0)	460 - 1.6 441 (500-1.6/2.4)
● CIRCLING	1090 - 2.8 1047 (1100-2.8)	1300 - 3.7 1257 (1300-3.7)	1300 - 4.6 1257 (1300-4.6)

TACAN RWY 07

67°16.15' N
014°21.92' E

BODOE (ENBO)

CHANGES/EDITORIALS

MIPS

RNOCAF 25 DEC 2025

MIPS
INSTRUMENT APPROACH CHART

HPMA ILS or LOC RWY 25
BODOE (ENBO)

AD ELEV 43

ATIS 123.900	BODOE APP 119.700 124.000 277.300 259.025			BODOE TWR 118.100 398.650 257.800			BODOE GND 121.750 358.475	
-----------------	--	--	--	--------------------------------------	--	--	------------------------------	--

ILS/DME BD 108.700 / CH 24X	APP COURSE 262°	GS INTCP ALT 3000	GS 3.5°	DA 493	THR ELEV 40	ALS 750 m	LDA 9166
--------------------------------	--------------------	----------------------	------------	-----------	----------------	--------------	-------------

WARNING:

- a) LOCALIZER OFFSET 10° SOUTH OF RWY CENTERLINE.

CAUTION:

- CIRCLING NOT AUTHORIZED NORTH OF RWY 25 / 07.
c) STEEP INTERMEDIATE SEGMENT FROM BOO 14.1 DME TO FAF (3.5°).

NOTE:

- d) DME REQUIRED.
e) DME FROM BOO. UNLESS INDICATED OTHERWISE.
f) BALAK AND ROSVI MAX HOLDING SPEED 230 KIAS.
g) VSS PENETRATED S OF FINAL 0.3 NM FM THR 25.

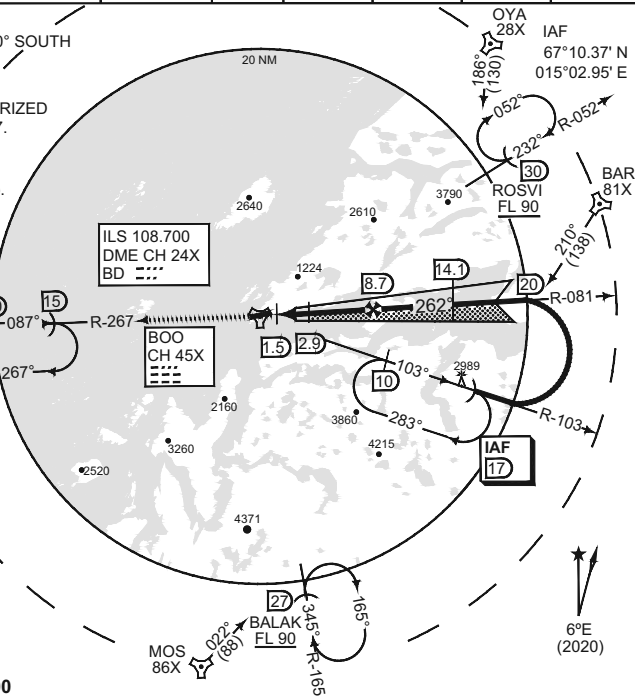

SAFE ALT 100 NM 9200

DME	2	3	4	5	6	7	8
ALT BOO	500	870	1250	1620	2000	2390	2770
ALT BD	790	1160	1540	1920	2300	2680	3070



MISSED APPROACH

TACAN
At 1.5 DME climb straight ahead and intercept BOO R-267 outbound.
Climb to 4000 ft and hold.

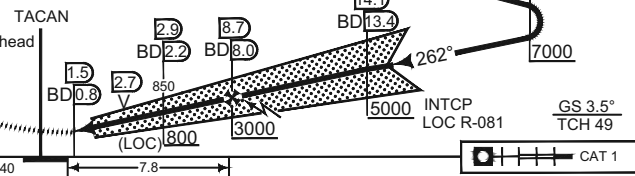

THR ELEV 40	7.8	CAT 1
-------------	-----	-------

CATEGORY	HPMA
S-ILS 25	493 - 1.4 453 (500 - 1.4/2.1)
S-LOC 25	750 - 3.2 710 (800 - 3.2/4.0)
● CIRCLING	1090 - 3.2 1047 (1100 - 3.2)

HPMA ILS or LOC RWY 25

67°16.15' N
014°21.92' E

BODOE (ENBO)

CHANGES: PAGE SIZE
MIPS

RNDATF 08 AUG 2024

MIPS
INSTRUMENT APPROACH CHART

ILS M or LOC M RWY 25
BODOE (ENBO)

AD ELEV 43

ATIS 123.900		BODOE APP 119.700 124.000 277.300 259.025			BODOE TWR 118.100 398.650 257.800			BODOE GND 121.750 358.475	
ILS/DME BD 108.700 / CH 24X		APP COURSE 262°	GS INTCP ALT 3000	GS 3.5°	DA SEE CAT	THR ELEV 41	ALS 750 m	LDA 9166	

WARNING:

a) LOCALIZER OFFSET 10° SOUTH OF RWY CENTERLINE.

CAUTION:

- CIRCLING NOT AUTHORIZED NORTH OF RWY 25 / 07.
- c) STEEP INTERMEDIATE SEGMENT FROM BOO 14.1 DME TO FAF (3.5°).

NOTE:

- d) DME REQUIRED.
- e) DME FROM BOO. UNLESS INDICATED OTHERWISE.
- f) BALAK AND ROSVI MAX HOLDING SPEED 230 KIAS.
- g) VSS PENETRATED S OF FINAL 0.3 NM FM THR 25.

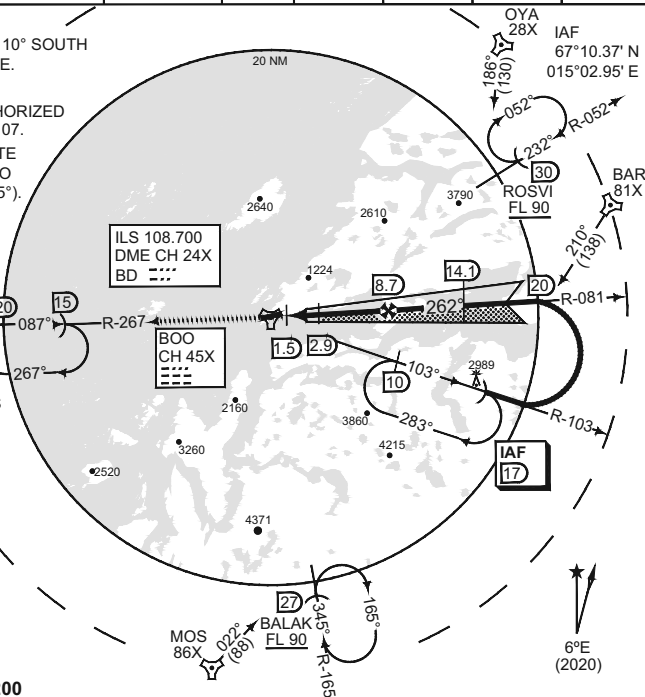

MSA BOO 25 NM

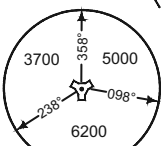

SAFE ALT 100 NM 9200

DME	2	3	4	5	6	7	8
ALT BOO	500	870	1250	1620	2000	2390	2770
ALT BD	790	1160	1540	1920	2300	2680	3070



MISSED APPROACH

At 1.5 DME climb straight ahead and intercept BOO R-267 outbound. Climb to 4000 ft and hold.

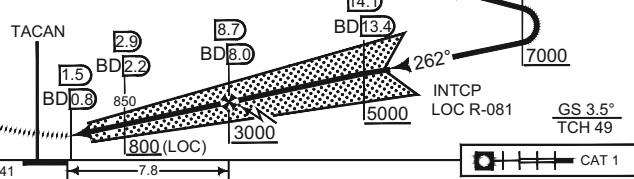

THR ELEV 41	7.8	CAT 1
-------------	-----	-------

CATEGORY	B	C	D
S-ILS 25	388 - 0.8 347 (400 - 0.8/1.2)	452 - 1.2 411 (500 - 1.2/2.0)	518 - 1.6 477 (500 - 1.6/2.4)
S-LOC 25	640 - 0.8 599 (600 - 0.8/1.6)	690 - 2.0 649 (700 - 2.0/2.8)	750 - 2.8 709 (700 - 2.8/3.6)
● CIRCLING	1090 - 2.4 1047 (1100 - 2.4)	1300 - 3.7 1257 (1300 - 3.7)	1300 - 4.6 1257 (1300 - 4.6)

ILS M or LOC M RWY 25

67°16.15' N
014°21.92' E

BODOE (ENBO)

CHANGES: PAGE SIZE MIPS

INDOAF 08 JUL 2024

MIPS INSTRUMENT APPROACH CHART

AD ELEV 43

HPMA TACAN A BODOE (ENBO)

ATIS 123.900	BODOE APP 119.700 124.000 277.300 259.025			BODOE TWR 118.100 398.650 257.800		BODOE GND 121.750 358.475	
TACAN BOO CH 45X	APP COURSE 263°	FAF ALT 3100		MDA 1090			

CAUTION:
● CIRCLING NOT AUTHORIZED NORTH OF RWY 25 / 07.

NOTE:
b) BALAK AND ROSVI
MAX HOLDING SPEED
230 KIAS.

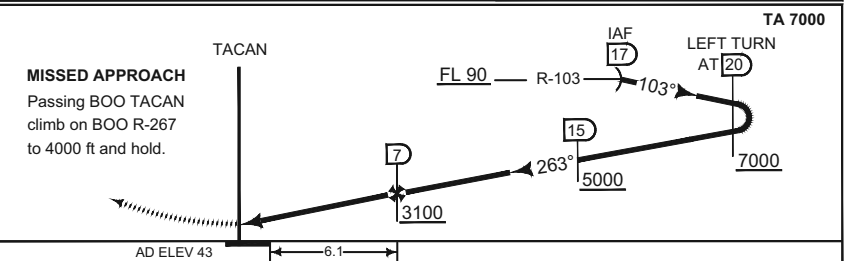
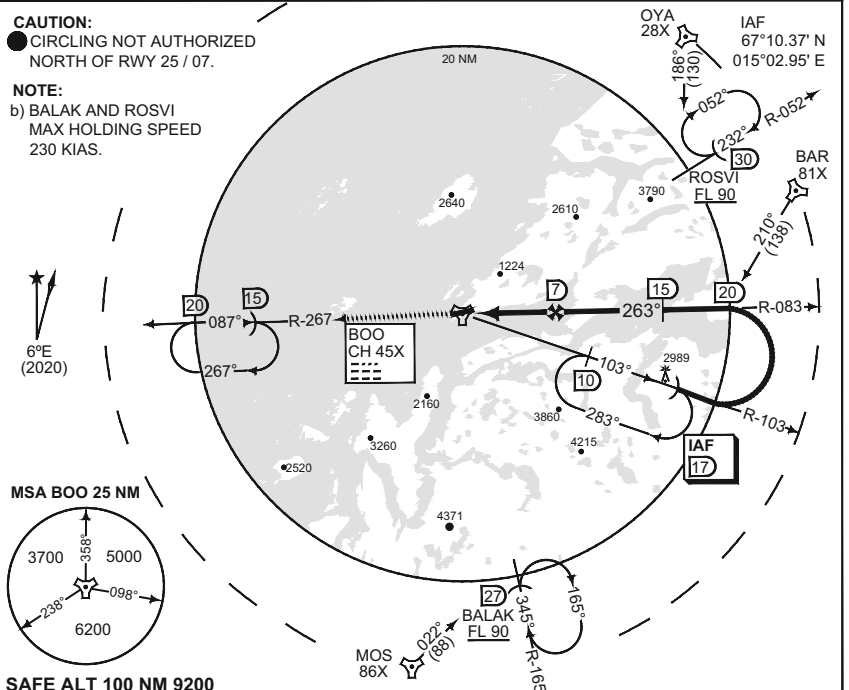

AD ELEV 43	6.1	1090	1047 (1100 - 3.2)
CATEGORY	HPMA		
● CIRCLING	1090 - 3.2 1047 (1100 - 3.2)		

HPMA TACAN A

67°16.15' N
014°21.92' E

BODOE (ENBO)

CHANGES: PAGE SIZE MIPS

RND/AF 08 AUG 2024

MIPS
INSTRUMENT APPROACH CHART

AD ELEV 43

TACAN A
BODOE (ENBO)

ATIS 123.900	BODOE APP 119.700 124.000 277.300 259.025	BODOE TWR 118.100 398.650 257.800	BODOE GND 121.750 358.475
TACAN BOO CH 45X	APP COURSE 263°	FAF ALT 3300	MDA SEE CAT

CAUTION:
● CIRCLING NOT AUTHORIZED
NORTH OF RWY 25 / 07.

NOTE:
b) BALAK AND ROSVI
MAX HOLDING SPEED
230 KIAS.

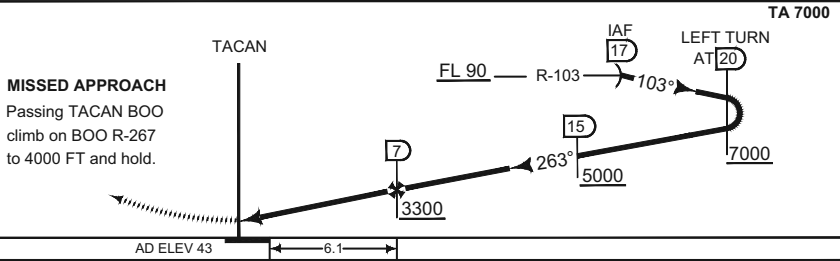
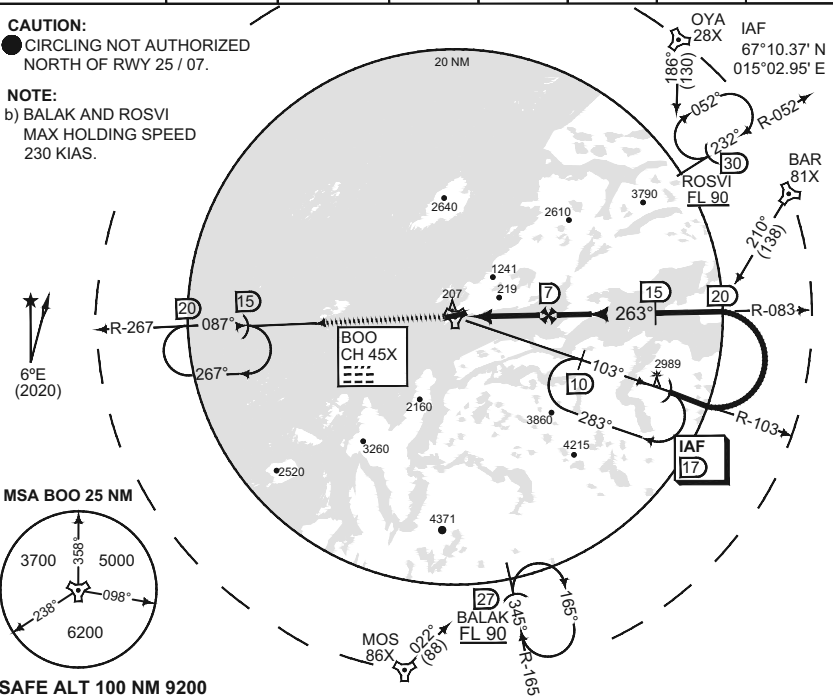

CATEGORY	B	C	D
● CIRCLING	1090 - 2.4 1047 (1100 - 2.4)	1300 - 3.7 1257 (1300 - 3.7)	1300 - 4.6 1257 (1300 - 4.6)

TACAN A

67°16.15' N
014°21.92' E

BODOE (ENBO)

CHANGES: PAGE SIZE
MIPS

RNOAF 08 AUG 2024

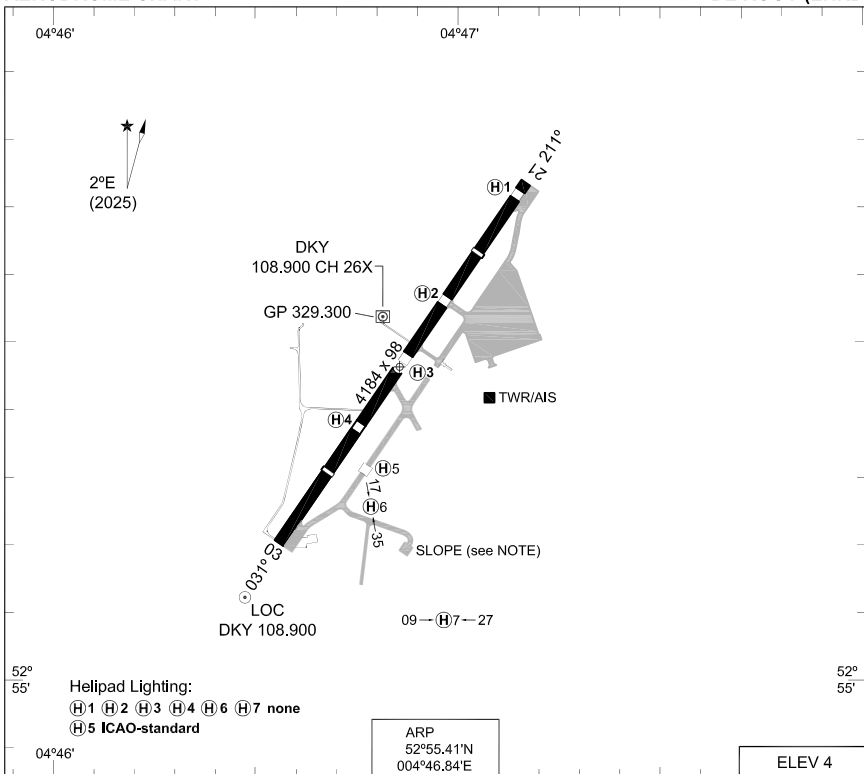

Helipad Lighting:

- (H1) (H2) (H3) (H4) (H6) (H7) none
- (H5) ICAO-standard

ARP
52°55.41'N
004°46.84'E

ELEV 4

RWY	PCN	TORA	ASDA	TODA	LDA	THR ELEV	THR PSN
21	62 F/A/W/T	4184	4184	4381	3377	2	52°55.58'N 004°47.03'E
03	62 F/A/W/T	3789	3789	3986	3334	3	52°55.19'N 004°46.59'E

DE KOOY TWR 379.750 120.130 121.730 or 379.750 (Ground Control)
DE KOOY ARRIVAL 372.150 124.230

SRA	PROC. CRITERIA	RWY	GS	TCH	OTCH	RPI	CAT	MINIMA CRITERIA	MINIMA
	MIPS	21					ABH	MIPS	500-1500 498 (500-1.5/2.3)
	MIPS	03					ABH	MIPS	420-1700 417 (500-1.7/1.9)

NOTE: SLOPE; WESTSIDE 5°, SOUTHSIDE 10°.

MIPS
INSTRUMENT APPROACH CHART

RNP Y RWY 03
DE KOOY (EHKD)

AD ELEV 4

DUTCH MIL 259.250 128.355		DE KOOY ARRIVAL 372.150 124.230		DE KOOY TWR 379.750 120.130		GND CTL 379.750 121.730		ATIS* 133.010		
EGNOS CHANNEL 69781 E03A		APP COURSE 031°	FAF ALT 1200 FT	Descent GR 6.5% / 3.72°		MDA 350	DA 203	THR ELEV 3	ALS 360 m	LDA 3334 FT

NOTE:

- a) ALL DISTANCES ARE RELATED TO THRESHOLD.
- b) PAPI 3° - NOT ALIGNED WITH INSTRUMENT PROCEDURE VERTICAL PATH.

RNP APCH
CAT H ONLY

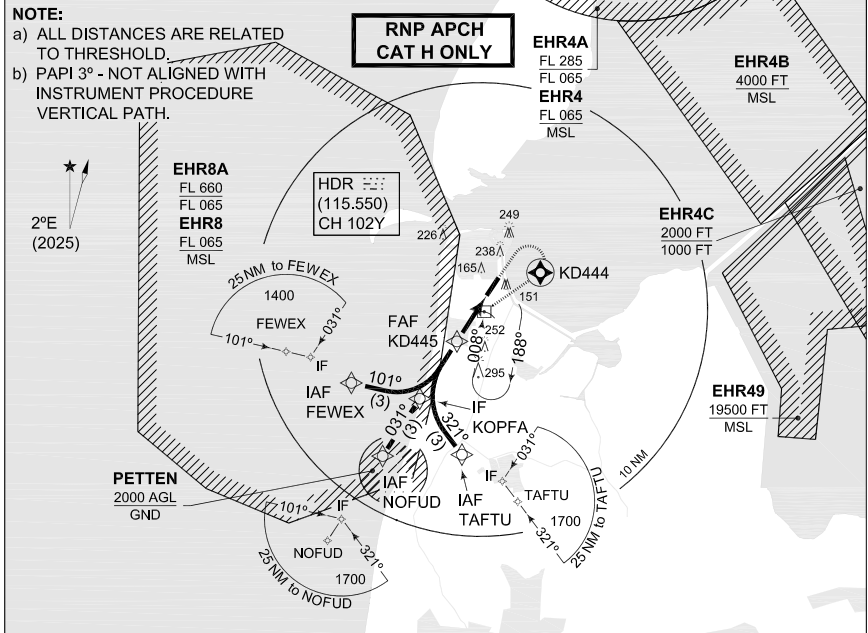

EMERG SAFE ALT 100 NM 2300

GS 3.72°	TA 3000			
TCH 50	MAPt	1	2	2.9
	ALT	450	840	1200

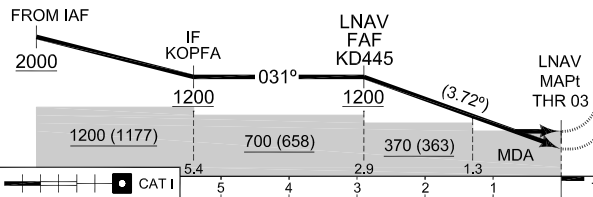

MISSED APPROACH
At MAPt maintain final track 031° MAG and climb to 2000 ft AMSL. At 1000 ft AMSL turn right to KD444. At KD444 turn right to HDR and join the holding at 2000 ft AMSL. Inform ATC.

CATEGORY		H	
DA(H)	LPV	203-1000 200 (200-1.0/1.2)	
DA(H)	LNAV / VNAV	244-1000 241 (300-1.0/1.6)	
MDA(H)	LNAV	350-1400 347 (400-1.4/1.6)	

IAWP	FEWEX	52°51.42'N	004°36.82'E	FAWP	KD445	52°52.78'N	004°43.92'E
IAWP	NOFUD	52°48.22'N	004°38.87'E	MAWP	THR 03	52°55.19'N	004°46.59'E
IAWP	TAFTU	52°48.29'N	004°44.54'E	MATWP	KD444	52°56.31'N	004°49.78'E
IWP	KOPFA	52°50.71'N	004°41.62'E	HF	HDR	52°54.41'N	004°45.94'E

RNP Y RWY 03

52°55.41'N
004°46.84'E

DE KOOY (EHKD)

CHANGES: EDITORIAL

RNLASF 16 APR 2026

MIPS
INSTRUMENT APPROACH CHART

RNP Z RWY 03
DE KOOY (EHKD)

AD ELEV 4

DUTCH MIL 259.250 128.355		DE KOOY ARRIVAL 372.150 124.230		DE KOOY TWR 379.750 120.130		GND CTL 379.750 121.730		ATIS* 133.010	
EGNOS CHANNEL N.A.	APP COURSE 008°	FAF ALT 2000 FT	Descent GR 5.24% / 3.00°	MDA SEE CAT	DA N.A.	THR ELEV 3	ALS 360 m	LDA 3334 FT	

NOTE:

- a) FINAL TRACK 23 DEG OFFSET FROM RWY MAPt
- b) ALL DISTANCES ARE RELATED TO MAPt.

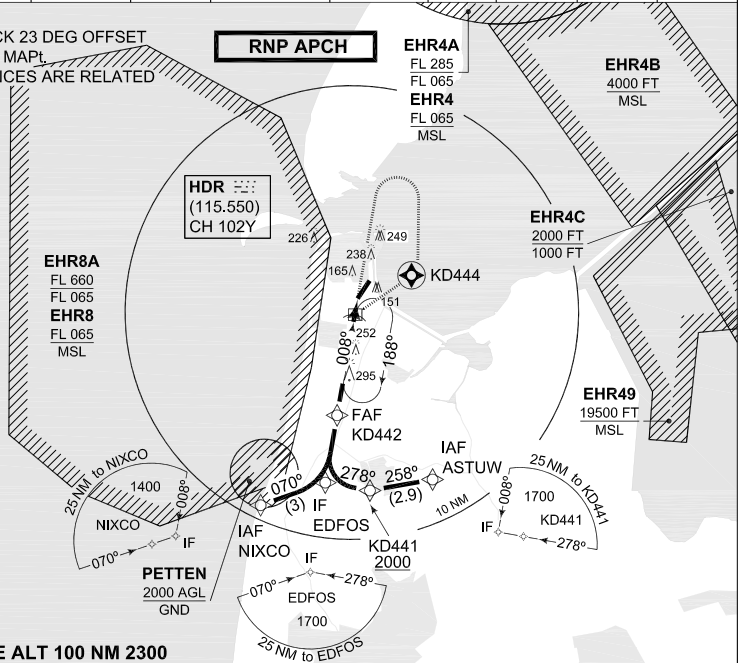

EMERG SAFE ALT 100 NM 2300

GS 3.00°	TA 3000	MAPt	1	2	3	4	5	5.2
TCH 50		ALT	650	970	1290	1610	1920	2000

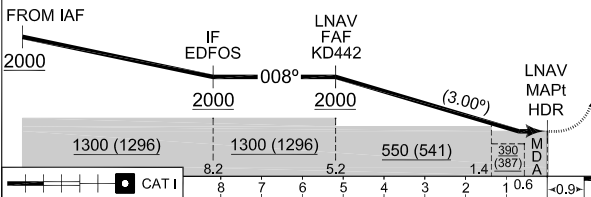

MISSED APPROACH
At MAPt maintain final track 008° MAG and climb to 2000 ft AMSL. At 1000 ft AMSL turn right to KD444. At KD444 turn right to HDR and join the holding at 2000 ft AMSL. Inform ATC.

CATEGORY		A		B		H	
MIPS	DA(H) LPV	NOT AUTHORIZED					
	DA(H) LNAV / VNAV	NOT AUTHORIZED					
	MDA(H) LNAV	390 -1600 387 (400-1.6/1.8)	420 -1700 417 (500-1.7/1.9)	320 -1200 317 (400-1.2/1.4)			

IAWP	ASTUW	52°46.47'N	004°51.35'E	FAWP	KD442	52°49.31'N	004°44.36'E
WP	KD441	52°46.00'N	004°46.68'E	MAWP	HDR	52°54.41'N	004°45.94'E
IAWP	NIXCO	52°45.44'N	004°38.75'E	MATWP	KD444	52°56.31'N	004°49.78'E
IWP	EDFOF	52°46.36'N	004°43.44'E	HF	HDR	52°54.41'N	004°45.94'E

RNP Z RWY 03

52°55.41'N
004°46.84'E

DE KOOY (EHKD)

CHANGES: EDITORIAL

RNLASF 16 APR 2026

MIPS
INSTRUMENT APPROACH CHART

ILS or LOC RWY 21
DE KOOY (EHKD)

AD ELEV 4

DUTCH MIL 259.250 128.355		DE KOOY ARRIVAL 372.150 124.230		DE KOOY TWR 379.750 120.130		GND CTL 379.750 121.730		ATIS* 133.010	
LOCALIZER/DME DKY 108.900 / CH 26X		APP COURSE 212°	GS INTCP ALT 2000 FT	GS 3°	DA 202	THR ELEV 2	ALS 870 m	LDA 3377 FT	

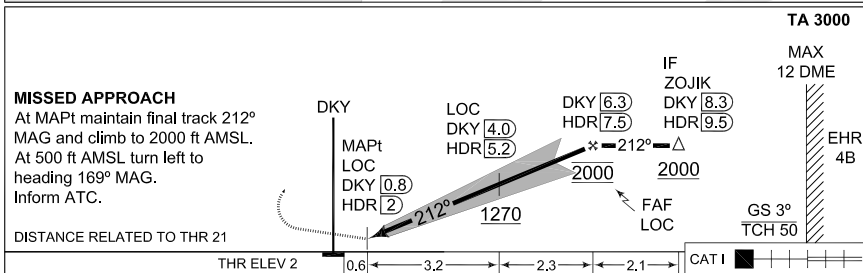
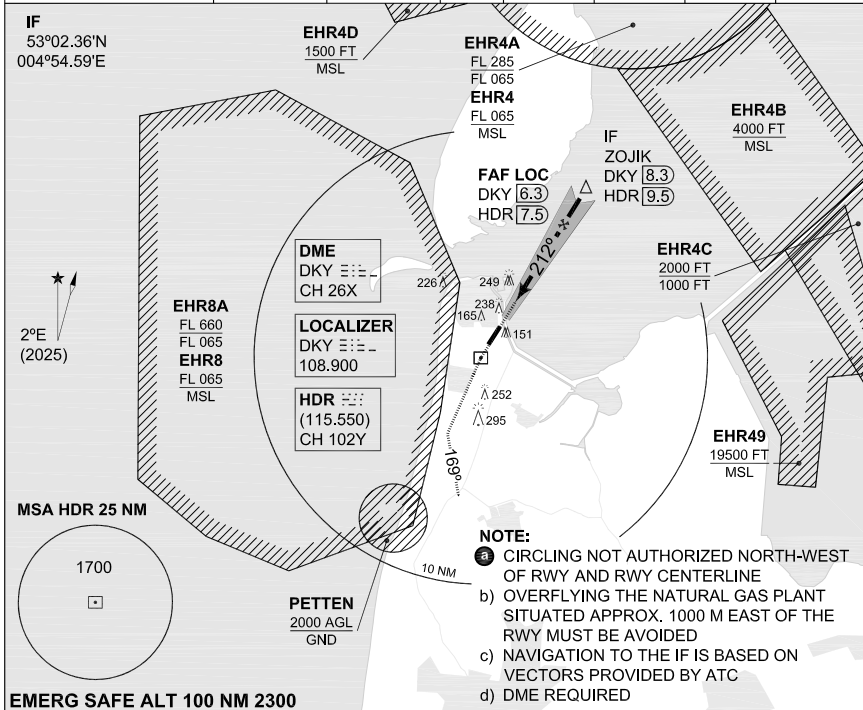

CATEGORY	A		B		H	
S-ILS 21	202-800 200 (200-0.8)				202-400 200 (200-0.4)	
CIRCLING ⓐ	510-1900 506 (600-1.9)		550-2800 546 (600-2.8)		510-1900 506 (600-1.9)	
S-LOC 21	330-800 328 (400-0.8)				330-400 328 (400-0.4)	

ILS or LOC RWY 21

52°55.41'N
004°46.84'E

DE KOOY (EHKD)

CHANGES: EDITORIAL

RNLASF 16 APR 2026

MIPS
INSTRUMENT APPROACH CHART

COPTER ILS or LOC RWY 21
DE KOOY (EHKD)

AD ELEV 4

DUTCH MIL 259.250 128.355	DE KOOY ARRIVAL 372.150 124.230	DE KOOY TWR 379.750 120.130	GND CTL 379.750 121.730	ATIS* 133.010
LOCALIZER/DME DKY 108.900 / CH 26X	APP COURSE 212°	GS INTCP ALT 2000 FT	GS 3°	DA 202
			THR ELEV 2	ALS 870 m
				LDA 3377 FT

NOTE:

- a) OVERFLYING THE NATURAL GAS PLANT SITUATED APPROX. 1000 M EAST OF THE RWY MUST BE AVOIDED
- b) VOR/DME SPL REQUIRED
- c) 116° INTERCEPTION ANGLE BTN INITIAL AND INTERMEDIATE TRACK



MSA HDR 25 NM

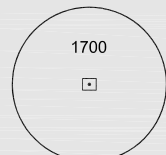

EMERG SAFE ALT 100 NM 2300

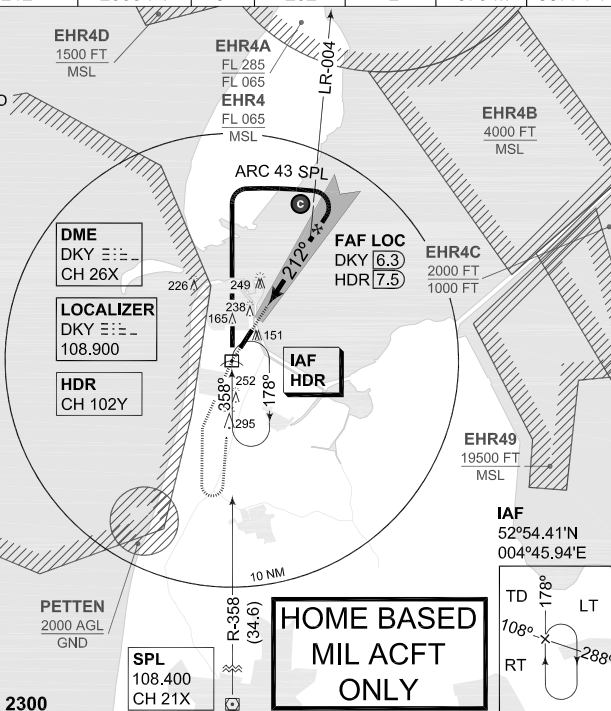

MISSED APPROACH

At MAPt maintain final track 212° MAG and climb to 2000 ft AMSL. At 1000 ft AMSL turn left to heading 178°. At 2000 ft turn left inbound IAF. Intercept the holding at 2000 ft AMSL. Inform ATC.

DISTANCE RELATED TO THR 21

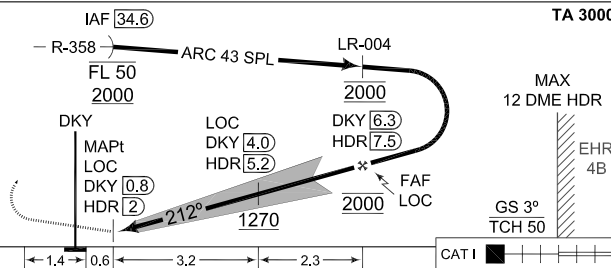

THR ELEV 2	← 1.4 → 0.6 → 3.2 → 2.3 →	CAT I
------------	---------------------------	-------

CATEGORY	H
S-ILS 21	202-400 200 (200-0.4/0.8)
S-LOC 21	330-400 328 (400-0.4/0.8)

CHANGES: EDITORIAL

COPTER ILS or LOC RWY 21

52°55.41'N
004°46.84'E

DE KOOY (EHKD)

RNLASF 16 APR 2026

MIPS INSTRUMENT APPROACH CHART

RNP Y RWY 21 DE KOOY (EHKD)

AD ELEV 4

DUTCH MIL 259.250 128.355		DE KOOY ARRIVAL 372.150 124.230		DE KOOY TWR 379.750 120.130		GND CTL 379.750 121.730		ATIS* 133.010	
EGNOS CHANNEL 57187 E21B	APP COURSE 212°	FAF ALT 1200 FT	Descent GR 7.87% / 4.50°	MDA 430	DA 242	THR ELEV 2	ALS 870 m	LDA 3377 FT	

NOTE:

- a) ALL DISTANCES ARE RELATED TO THRESHOLD.
- b) PAPI 3° - NOT ALIGNED WITH INSTRUMENT PROCEDURE VERTICAL PATH.
- c) MINIMUM TEMPERATURE -20°.

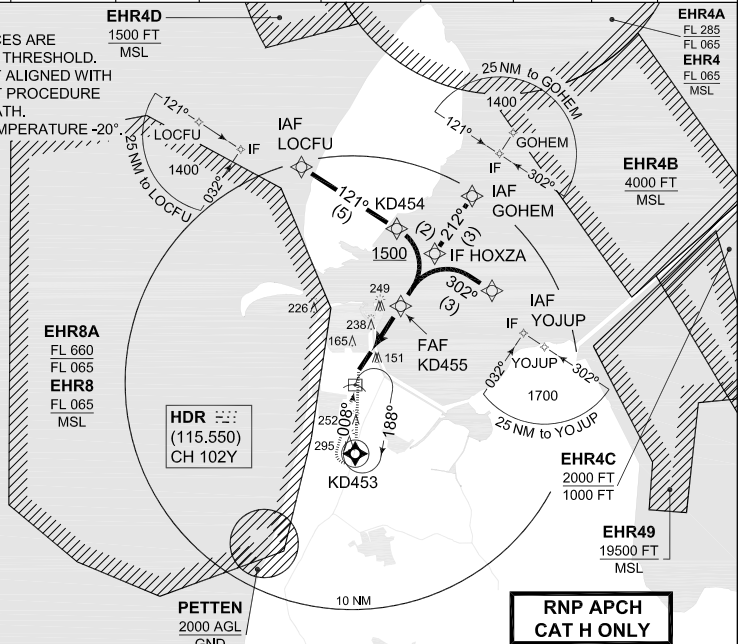

EMERG SAFE ALT 100 NM 2300

MAPI	1	2	2.4	TA 3000	GS 4.50°
ALT	540	1030	1200		TCH 50

MISSED APPROACH

At MAPt maintain final track 212° MAG and climb to 2000 ft AMSL. At 500 ft AMSL turn left to KD453. At KD453 turn right to HDR and join the holding at 2000 ft AMSL. Inform ATC.

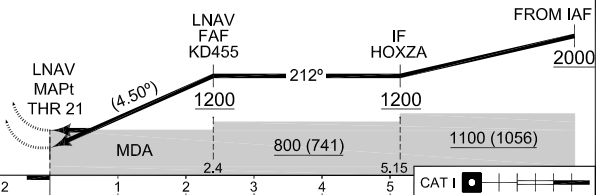

CATEGORY		H					
MIPS	DA(H) LPV	222-800 220 (300-0.8/1.2)					
	DA(H) LNAV / VNAV	334-800 332 (400-0.8/1.5)					
	MDA(H) LNAV	430-1300 428 (500-1.3/2.0)					
IAWP	LOCFU	53°03.75'N	004°42.16'E	FAWP	KD455	52°57.57'N	004°49.25'E
WP	KD454	53°00.97'N	004°49.04'E	MAWP	THR 21	52°55.58'N	004°47.03'E
IAWP	GOHEM	53°02.34'N	004°54.56'E	MATWP	KD453	52°51.42'N	004°45.89'E
IAWP	YOJUP	52°58.17'N	004°55.90'E	HF	HDR	52°54.41'N	004°45.94'E
IWP	HOXZA	52°59.85'N	004°51.79'E				

RNP Y RWY 21

52°55.41'N
004°46.84'E

DE KOOY (EHKD)

MIPS
INSTRUMENT APPROACH CHART

RNP Z RWY 21
DE KOOY (EHKD)

AD ELEV 4

DUTCH MIL 259.250 128.355		DE KOOY ARRIVAL 372.150 124.230		DE KOOY TWR 379.750 120.130		GND CTL 379.750 121.730		ATIS* 133.010	
EGNOS CHANNEL 62338 E21A	APP COURSE 212°	FAF ALT 1700 FT	Descent GR 5.24% / 3.00°	MDA SEE CAT	DA SEE CAT	THR ELEV 2	ALS 870 m	LDA 3377 FT	

NOTE:
a) ALL DISTANCES ARE RELATED TO THRESHOLD.
b) MINIMUM TEMPERATURE -20°.

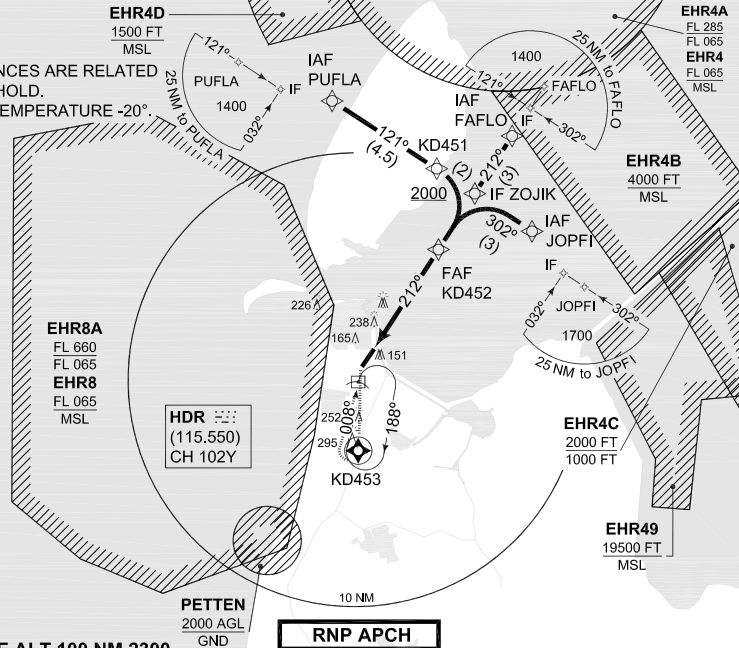

EMERG SAFE ALT 100 NM 2300

RNP APCH

MAPt	1	2	3	4	5	5.2	TA 3000	GS 3°
ALT	370	690	1010	1330	1650	1700		TCH 50

MISSED APPROACH
At MAPt maintain final track 212° MAG and climb to 2000 ft AMSL. At 500 ft AMSL turn left to KD453. At KD453 turn right to HDR and join the holding at 2000 ft AMSL. Inform ATC.

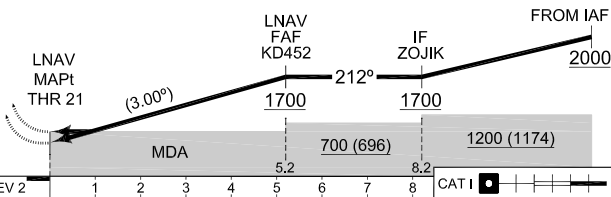

CATEGORY	A		B		H		
	DA(H) LPV	238-800 236 (300-0.8/1.2)		248-800 246 (300-0.8/1.3)		222-800 220 (300-0.8/1.2)	
DA(H) RNAV / VNAV	370-1000 368 (400-1.0/1.7)		382-1100 380 (400-1.1/1.8)		334-800 332 (300-0.8/1.5)		
MDA(H) RNAV	480-1500 478 (500-1.5/2.2)				430-1300 428 (500-1.3/2.0)		
IAWP	PUFLA	53°06.54'N	004°44.28'E	FAWP	KD452	52°59.87'N	004°51.81'E
WP	KD451	53°04.03'N	004°50.47'E	MAWP	THR 21	52°55.58'N	004°47.03'E
IAWP	FAFLO	53°04.84'N	004°57.38'E	MATWP	KD453	52°51.42'N	004°45.89'E
IAWP	JOPFI	53°00.68'N	004°58.71'E	HF	HDR	52°54.41'N	004°45.94'E
IWP	ZOJIK	53°02.36'N	004°54.59'E				

RNP Z RWY 21

52°55.41'N
004°46.84'E

DE KOOY (EHKD)

CHANGES: EDITORIAL

RNLASF 16 APR 2026

MIPS
AERODROME CHART

DEELEN (EHDL)

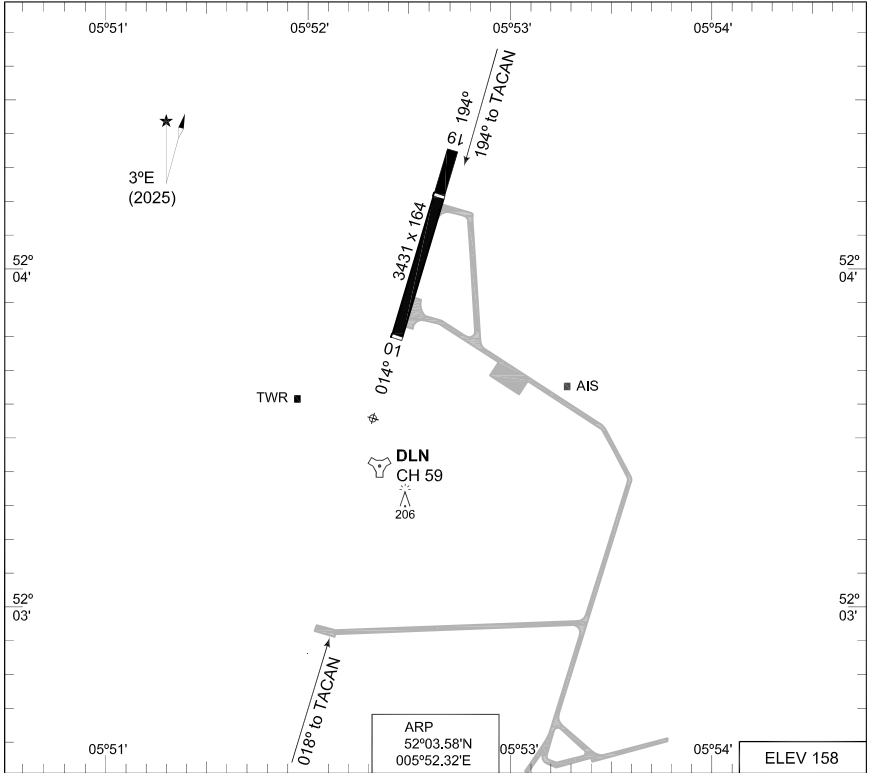

RWY	LCN	TORA	ASDA	TODA	LDA	THR ELEV	THR PSN
19	30	3431	3431	3431	2536	158	52°04.20'N 005°52.62'E
01	30	3431	3431	3431	3411	151	52°03.81'N 005°52.43'E

DEELEN TWR	312.400	129.930
RAPCON WEST	399.725	123.580

PROC. CRITERIA	RWY	GS	TCH	OTCH	RPI	CAT	MINIMA CRITERIA	MINIMA

CHANGES: EDITORIAL

RNLASF 16 APR 2026

AERODROME CHART

DEELEN (EHDL)

MIPS
INSTRUMENT APPROACH CHART

TACAN RWY 01
DEELEN (EHDL)

AD ELEV 158

DUTCH MIL 259.250 128.355		RAPCON WEST 399.725 123.580		DEELEN TWR 312.400 129.930			
TACAN DLN CH 59	APP COURSE 018°	FAF ALT 1600 FT	Descent GR 5.2%	MDA 530	THR ELEV 151	ALS -	LDA 3411 FT

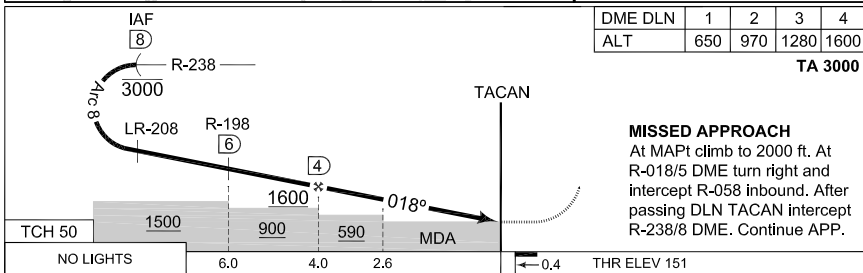
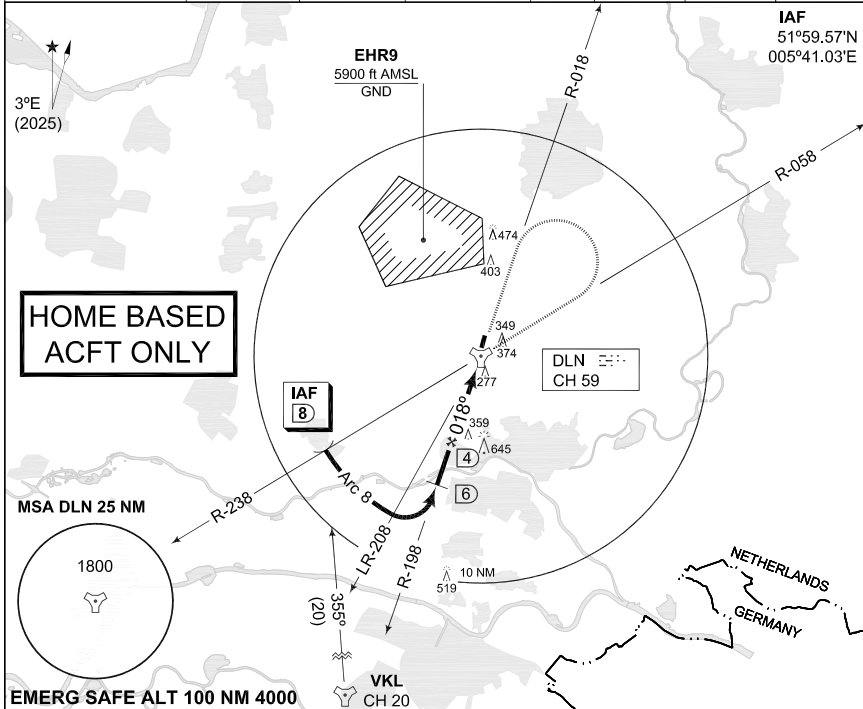

NO LIGHTS	6.0	4.0	2.6	0.4	THR ELEV 151
NO LIGHTS	6.0	4.0	2.6	0.4	THR ELEV 151
CATEGORY	COPTER	A	B	C	
S-TACAN 01	530-800 379 (400-0.8/0.8)	530-1700 379 (400-1.7/1.7)			
CIRCLING	NOT AUTHORIZED				

TACAN RWY 01

52°03.58'N
005°52.32'E

DEELEN (EHDL)

CHANGES: EDITORIAL

MIPS

RNLASF 16 APR 2026

MIPS INSTRUMENT APPROACH CHART

COPTER TACAN RWY 01 DEELEN (EHDL)

AD ELEV 158

DUTCH MIL 259.250 128.355		RAPCON WEST 399.725 123.580		DEELEN TWR 312.400 129.930			
TACAN DLN CH 59	APP COURSE 018°	FAF ALT 1600 FT	Descent GR 5.2%	MDA 530	THR ELEV 151	ALS -	LDA 3411 FT

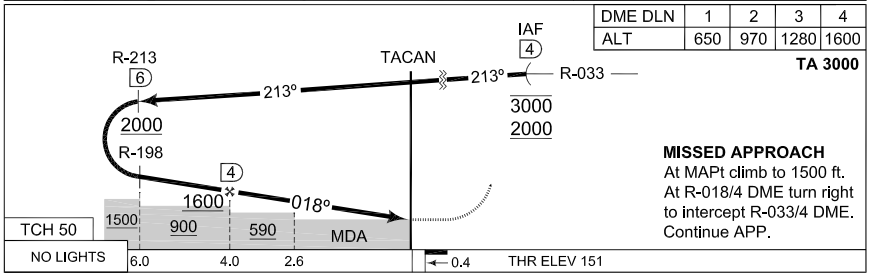
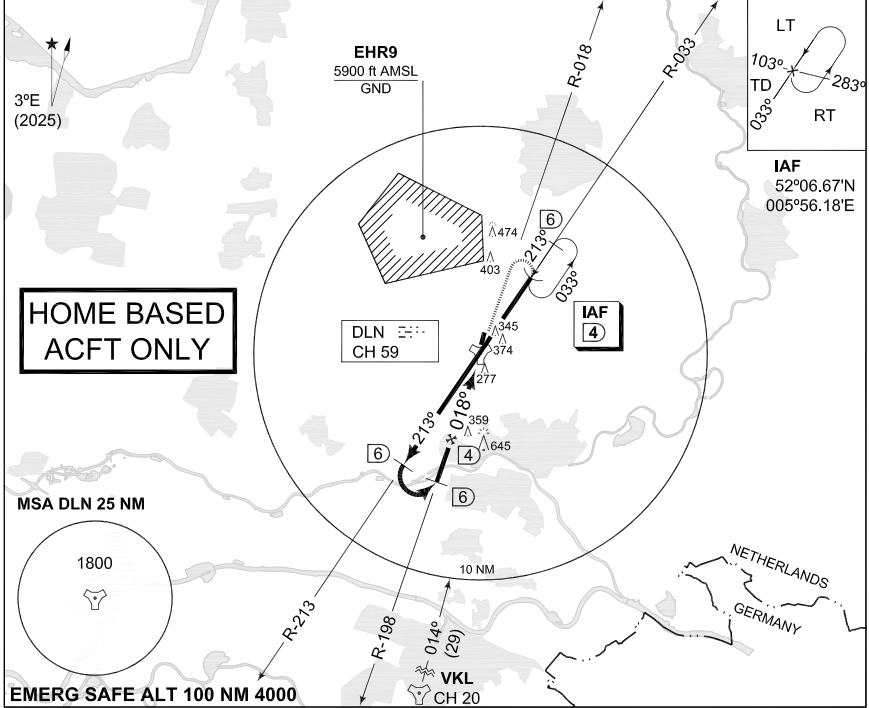

CATEGORY	COPTER
S-TACAN 01	530-800 379 (400-0.8/0.8)
CIRCLING	NOT AUTHORIZED

COPTER TACAN RWY 01

52°03.58'N
005°52.32'E

DEELEN (EHDL)

CHANGES: EDITORIAL

MIPS

RNLASF 16 APR 2026

MIPS INSTRUMENT APPROACH CHART

TACAN RWY 19 DEELEN (EHDL)

AD ELEV 158

DUTCH MIL 259.250 128.355		RAPCON WEST 399.725 123.580		DEELEN TWR 312.400 129.930			
TACAN DLN CH 59	APP COURSE 194°	FAF ALT 1500 FT	Descent GR 5.2%	MDA 650	THR ELEV 158	ALS 420 m	LDA 2536 FT

NOTE:

- a) DO NOT CROSS WEST OF R-007
- b) RADAR MONITORING MANDATORY

IAF

52°07.30'N
006°03.72'E

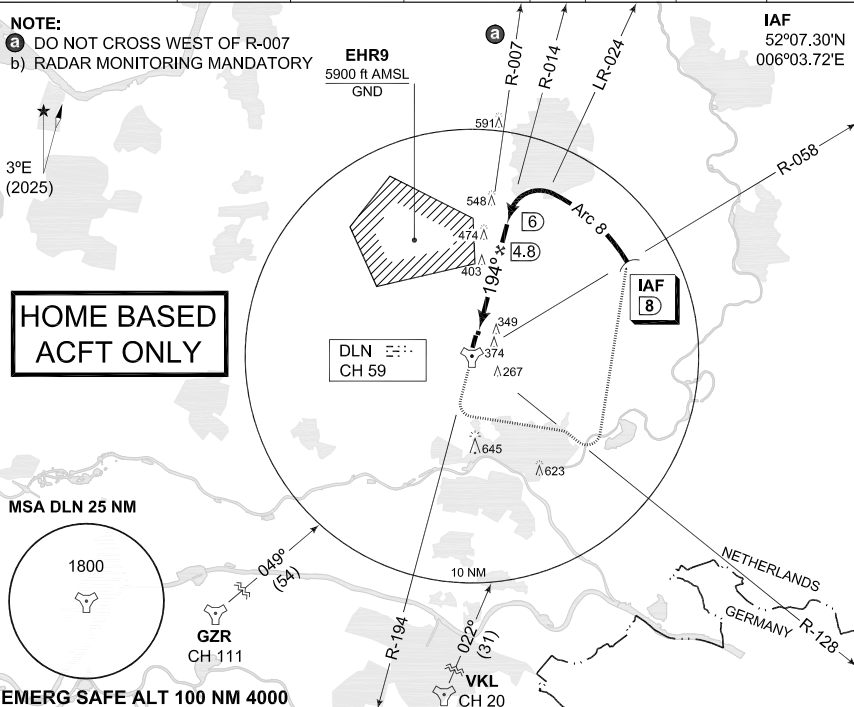

DME DLN	2	3	4	4.8
ALT	MDA	850	1160	1500

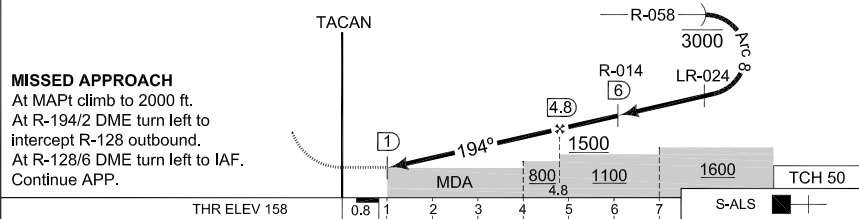

CATEGORY	COPTER	A	B	C
S-TACAN 19	650 -400 492 (500-0.4/0.8)	650 -1800 492 (500-1.8/2.3)		
CIRCLING	NOT AUTHORIZED			

TACAN RWY 19

52°03.58'N
005°52.32'E

DEELEN (EHDL)

CHANGES: EDITORIAL

MIPS

RNLASF 16 APR 2026

MIPS
INSTRUMENT APPROACH CHART

ILS or LOC RWY 19
DEELEN (EHDL)

AD ELEV 158

DUTCH MIL 259.250 128.355		RAPCON WEST 399.725 123.580		DEELEN TWR 312.400 129.930				
LOCALIZER / DME DNS 108.700 / CH 24X		APP COURSE 194°	GS INTCEPT ALT 1500 FT	GS 3°	DA SEE CAT	THR ELEV 158	ALS 420 m	LDA 2536 FT

NOTES:

- a) PROCEDURE ONLY ALLOWED FOR HOMEBASED HELICOPTERS UNDER VMC
- b) DO NOT CROSS WEST OF R-007
- c) RADAR MONITORING MANDATORY PRIOR PERMISSION REQUIRED

IAF
52°07.30'N
006°03.72'E

EHR9
5900 ft AMSL
GND

3°E
(2025)

**HOME BASED
ACFT ONLY**

DLN CH 59X

LOCALIZER
DNS 108.700
CH 24X

IAF
B

DME REQUIRED

MSA DLN 25 NM

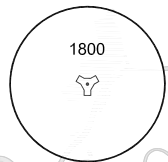

EMERG SAFE ALT 100 NM 4000

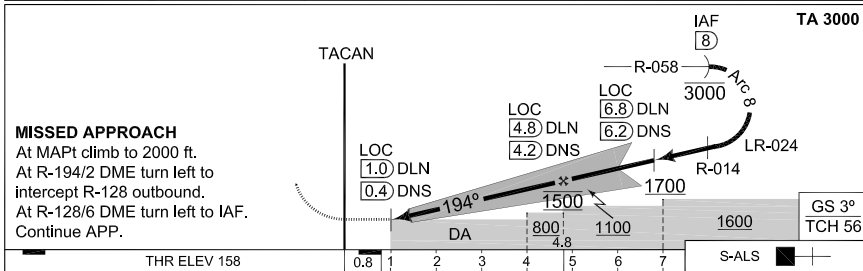

THR ELEV 158	0.8	1	2	3	4	5	6	7	S-ALS
--------------	-----	---	---	---	---	---	---	---	-------

CATEGORY	COPTER	A	B	C
S-ILS 20	388 -400 230 (300-0.4/0.8)	404 -800 246 (300-0.8/1.2)	414 -800 256 (300-0.8/1.3)	424 -900 266 (300-0.9/1.3)
S-LOC 20	640 -400 482 (500-0.4/0.8)	640 -1800 482 (500-1.8/2.3)		
CIRCLING	NOT AUTHORIZED			

ILS or LOC RWY 19

52°03.58'N
005°52.32'E

DEELEN (EHDL)

CHANGES: EDITORIAL

RNLASF 16 APR 2026

MIPS
INSTRUMENT APPROACH CHART

COPTER TACAN RWY 19
DEELEN (EHDL)

AD ELEV 158

DUTCH MIL 259.250 128.355		RAPCON WEST 399.725 123.580		DEELEN TWR 312.400 129.930			
TACAN DLN CH 59	APP COURSE 194°	FAF ALT 1500 FT	Descent GR 5.2%	MDA 650	THR ELEV 158	ALS 420 m	LDA 2536 FT

NOTE:

- a) DO NOT CROSS WEST OF R-007
- b) RADAR MONITORING MANDATORY

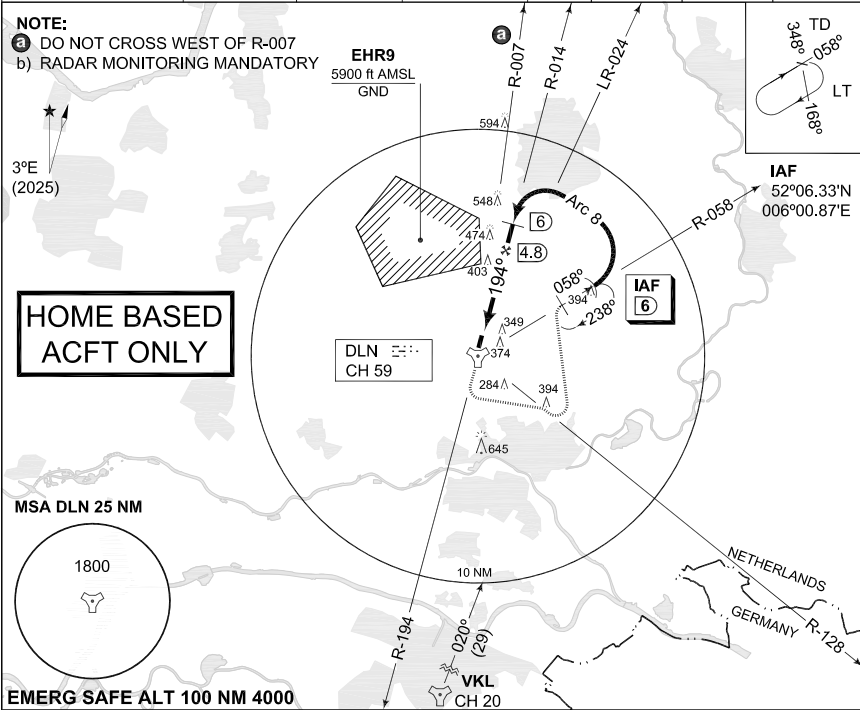

DME DLN	2	3	4	4.8
ALT	MDA	850	1160	1500

MISSED APPROACH
At MAP climb to 2000 ft.
At R-194/2 DME turn left to intercept R-128 outbound.
At R-128/4 DME turn left to intercept R-058/6 DME.
Continue APP.

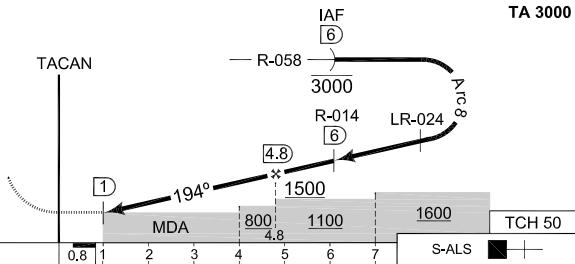

CATEGORY	COPTER
S-TACAN 19	650-400 492 (500-0.4/0.8)
CIRCLING	NOT AUTHORIZED

COPTER TACAN RWY 19

52°03.58'N
005°52.32'E

DEELEN (EHDL)

MIPS
AERODROME CHART

EINDHOVEN (EHEH)

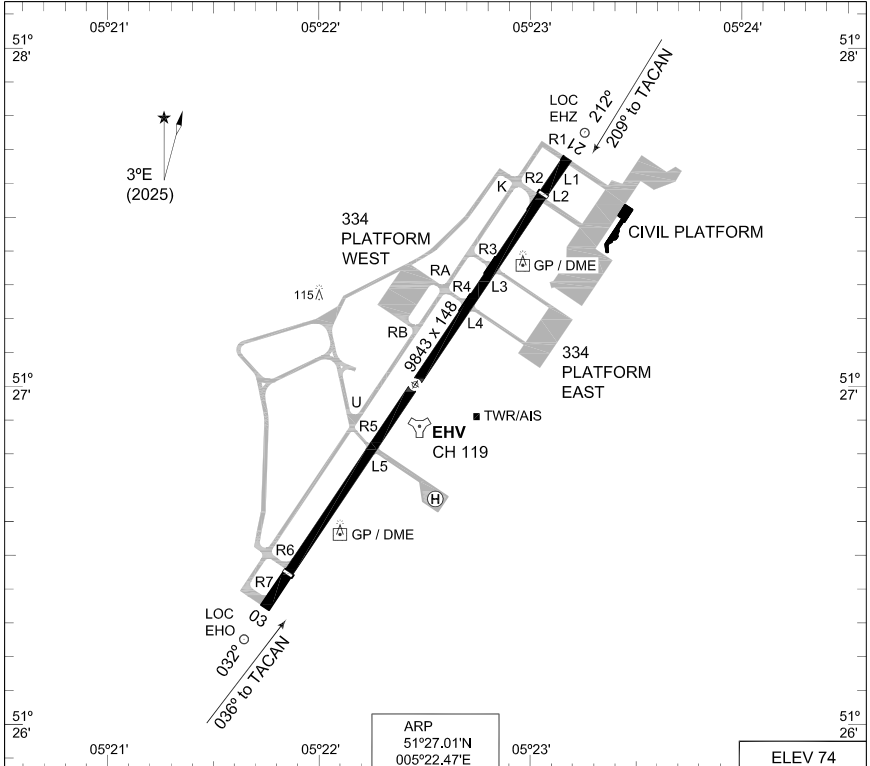

ARP
51°27.01'N
005°22.47'E

ELEV 74

RWY	PCN	TORA	ASDA	TODA	LDA	PAPI	THR ELEV	THR PSN
21	62 F/A/W/T	9844	9844	10041	9044	3.0°	67	51°27.56'N 005°23.09'E
03	62 F/A/W/T	9844	9844	10041	9044	3.0°	74	51°26.45'N 005°21.85'E

EINDHOVEN TWR 241.550 131.005 (Ground Control) 335.750 121.930
 EINDHOVEN ARRIVAL 265.975 124.530
 RAPCON SOUTH 388.525 123.180

PROC. CRITERIA	RWY	GS	TCH	OTCH	RPI	CAT	MINIMA CRITERIA	MINIMA

CHANGES: EDITORIAL

RNLASF 16 APR 2026

AERODROME CHART

EINDHOVEN (EHEH)

**MIPS
INSTRUMENT DEPARTURE CHART**

**EH1
EINDHOVEN (EHEH)**

AD ELEV 74

GND CTL 335.750 121.930		EINDHOVEN TWR 241.550 131.005		RAPCON SOUTH 388.525 123.180			DUTCH MIL 336.325 125.930		
RWY 21	Knots	120	180	240	300	360	to		
	V/V (fpm)	500	750	1000	1250	1500	3000 ft		
	V/V (fpm)	600	900	1200	1500	1800	FL 150		

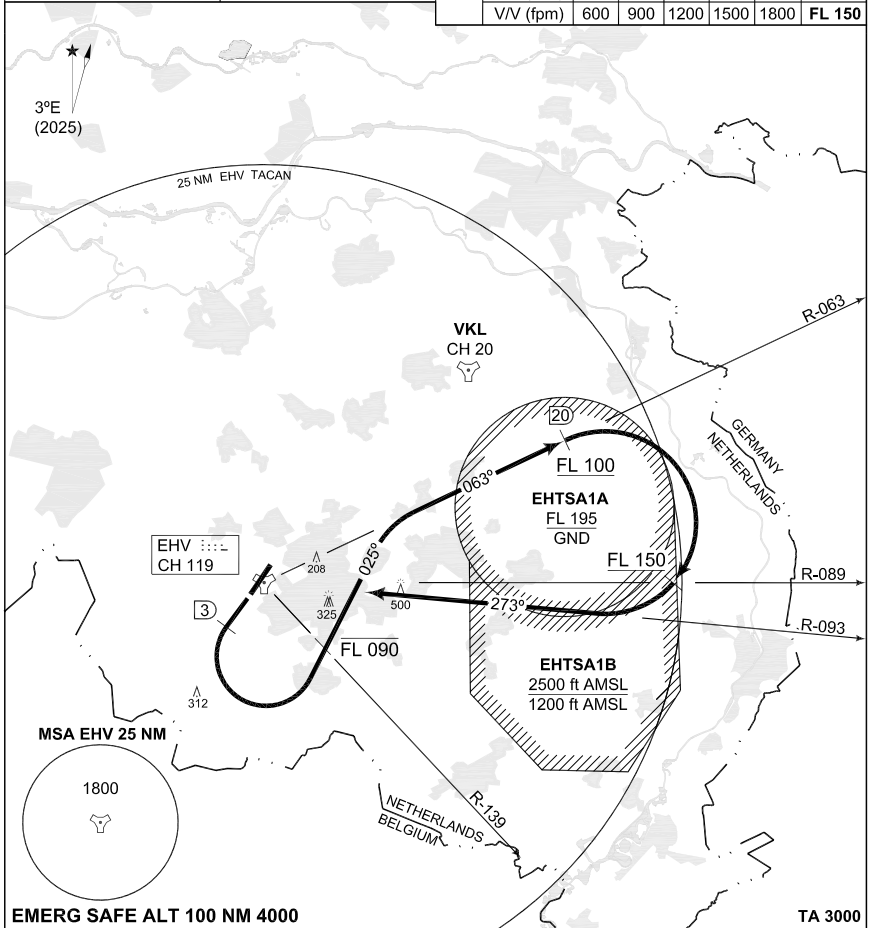

**EINDHOVEN 1
(RWY 21)**

- Climb straight ahead.
- At 3 DME and at least at 1000 ft from Eindhoven TACAN turn left, heading 025° to intercept R-063 outbound.
- FLIGHT LEVEL RESTRICTION: Cross R-139 at FL 090 or below.
- At 20 DME turn right to intercept R-093 inbound Eindhoven TACAN.
- FLIGHT LEVEL RESTRICTION: Pass 20 DME/R-064 at FL 100 or above, cross R-089 at FL 150 or above.

CHANGES: EDITORIAL

RNLASF 16 APR 2026

EH1

51°27.01'N
005°22.47'E

EINDHOVEN (EHEH)

**MIPS
INSTRUMENT DEPARTURE CHART**

**EH3
EINDHOVEN (EHEH)**

AD ELEV 74

GND CTL 335.750 121.930		EINDHOVEN TWR 241.550 131.005		RAPCON SOUTH 388.525 123.180			DUTCH MIL 336.325 125.930		
RWY 03	Knots	120	180	240	300	360	to		
	V/V (fpm)	960	1440	1920	2400	2880	FL 100		
	V/V (fpm)	720	1080	1440	1800	2160	FL 150		

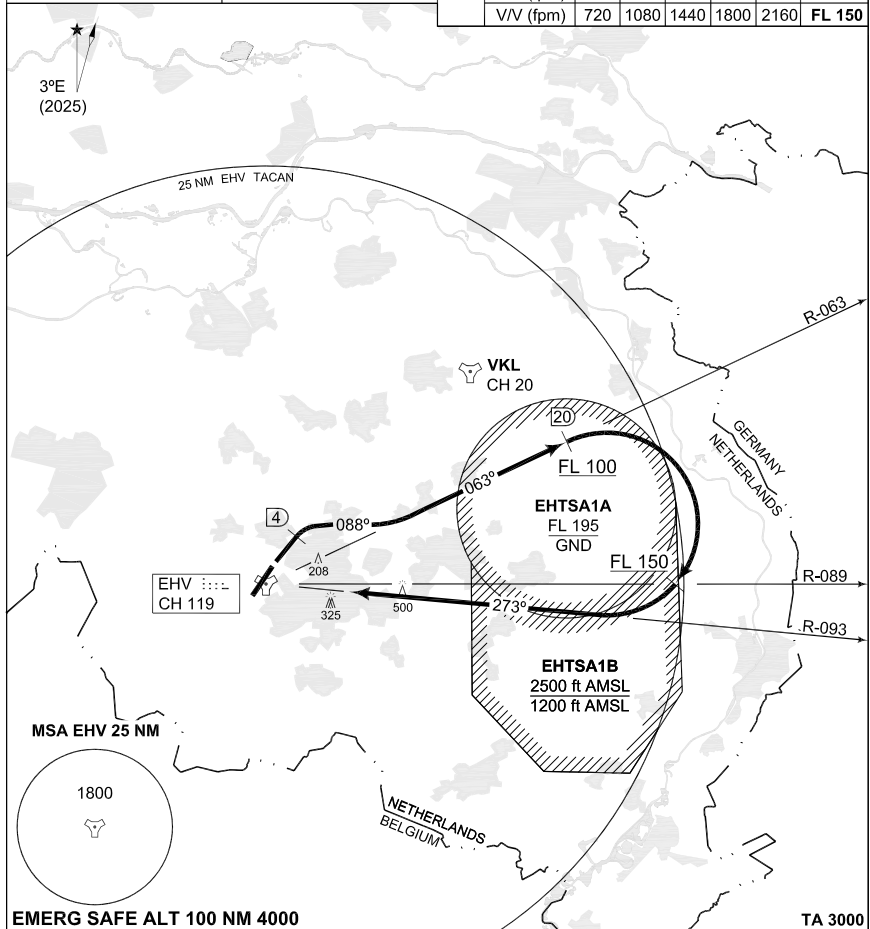

EINDHOVEN 3 (RWY 03)

- Climb straight ahead.
- At 4 DME and at least at 1000 ft from Eindhoven TACAN turn right, heading 088° to intercept R-063 outbound.
- At 20 DME turn right to intercept R-093 inbound Eindhoven TACAN.

FLIGHT LEVEL RESTRICTION: Pass 20 DME/R-063 at FL 100 or above, cross R-089 at FL 150 or above.

NOTE: ATC required minimum climb rate exceeds 300 ft/NM.

CHANGES: EDITORIAL

RNLASF 16 APR 2026

EH3

51°27.01'N
005°22.47'E

EINDHOVEN (EHEH)

MIPS
INSTRUMENT DEPARTURE CHART

EH5
EINDHOVEN (EHEH)

AD ELEV 74

GND CTL		EINDHOVEN TWR		RAPCON SOUTH			DUTCH MIL				
335.750	121.930	241.550	131.005	388.525	123.180		336.325	125.930			
EINDHOVEN ARRIVAL				RWY	Knots	120	180	240	300	360	to
265.975	124.530			21	V/V (fpm)	860	1290	1720	2150	2580	FL 180
					V/V (fpm)	800	1200	1600	2000	2400	FL 220

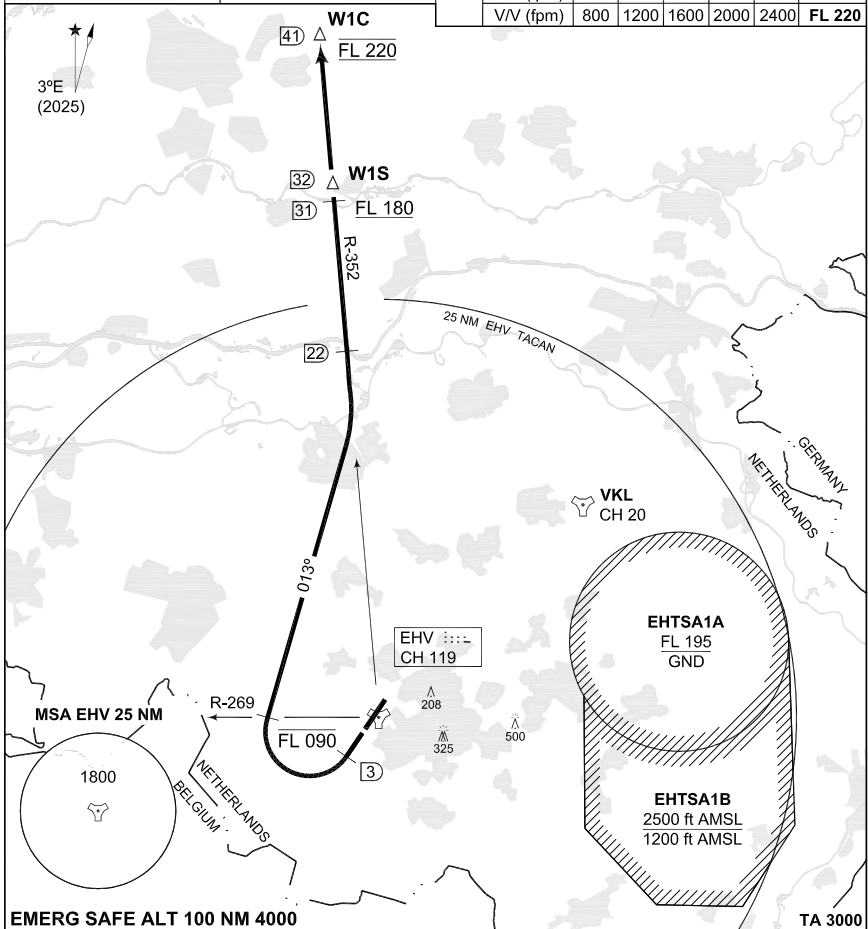

EMERG SAFE ALT 100 NM 4000

TA 3000

- EINDHOVEN 5 (RWY 21)**
- Climb straight ahead to 3 DME from Eindhoven TACAN (EHV).
 - Turn right heading 013° to intercept EHV R-352 outbound.
 - **FLIGHT LEVEL RESTRICTION:** Cross EHV R-269 at FL 090 or below.
 - Cross EHV R-352 outbound, 31 DME at FL 180 or above.
 - Cross EHV R-352 outbound, 41 DME at FL 220, unless instructed otherwise by ATC.

- NOTES:**
- Departure end crossing height: RWY 21: 74 ft.
 - If no radiocontact with Dutch Mil at EHV 22 DME turn right inbound EHV TACAN and contact RAPCON SOUTH.

CHANGES: EDITORIAL

RNLASF 16 APR 2026

EH5

51°27.01'N
005°22.47'E

EINDHOVEN (EHEH)

MIPS
INSTRUMENT DEPARTURE CHART

E7
EINDHOVEN (EHEH)

AD ELEV 74

GND CTL		EINDHOVEN TWR		RAPCON SOUTH				DUTCH MIL			
335.750	121.930	241.550	131.005	388.525	123.180			336.325	125.930		
EINDHOVEN ARRIVAL				RWY	Knots	120	180	240	300	360	to
265.975	124.530			03	V/V (fpm)	1140	1710	2280	2840	3410	FL 180
					V/V (fpm)	800	1200	1600	2000	2400	FL 220

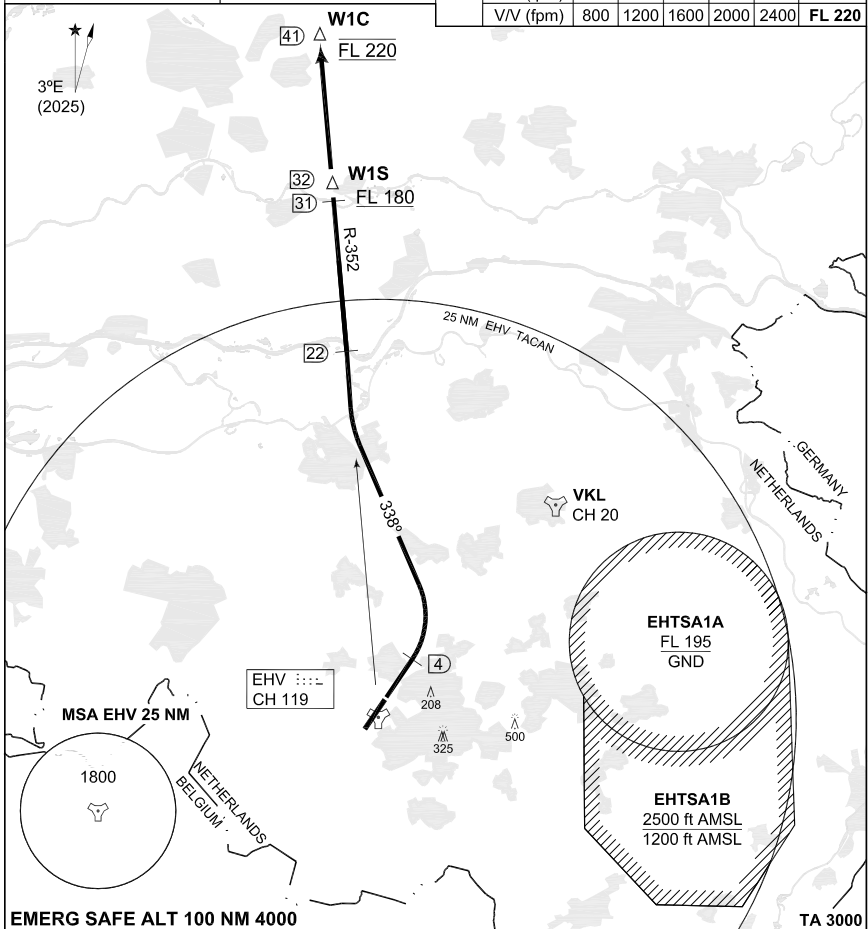

EMERG SAFE ALT 100 NM 4000

TA 3000

EINDHOVEN 7 (RWY 03)

- Climb straight ahead to 4 DME from Eindhoven TACAN (EHV).
- Turn left heading 338° to intercept EHV R-352 outbound.
- Cross EHV R-352 outbound, 31 DME at FL 180 or above.
- Cross EHV R-352 outbound, 41 DME at FL 220, unless instructed otherwise by ATC.

NOTES:

- Departure end crossing height: RWY 03: 66 ft.
- If no radiocontact with Dutch Mil at EHV 22 DME turn right inbound EHV TACAN and contact RAPCON SOUTH.

CHANGES: EDITORIAL

RNLASF 16 APR 2026

E7

51°27.01'N
005°22.47'E

EINDHOVEN (EHEH)

MIPS
INSTRUMENT APPROACH CHART

HI-LS or LOC RWY 03
EINDHOVEN (EHEH)

AD ELEV 74

DUTCH MIL 336.325 125.930		RAPCON SOUTH 388.525 123.180		EINDHOVEN TWR 241.550 131.005		GND CTL 335.750 121.930		ATIS* 126.030
LOCALIZER / DME EHZ 109.750 / CH 34Y		APP COURSE 032°	FAF ALT 2000 FT	GS 3°	DA SEE CAT	THR ELEV 74	ALS 892 m	LDA 9044 FT

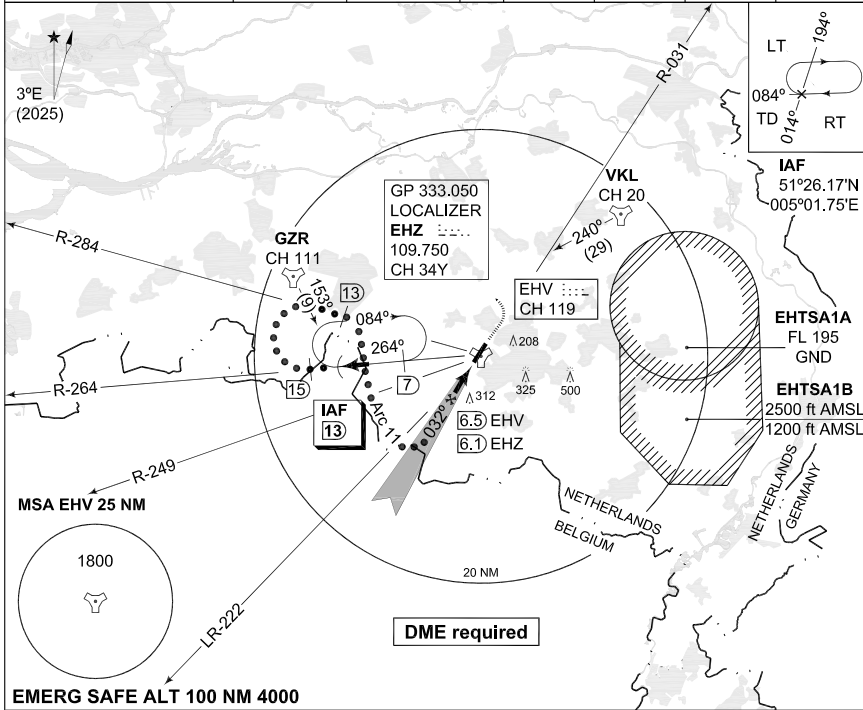

EMERG SAFE ALT 100 NM 4000

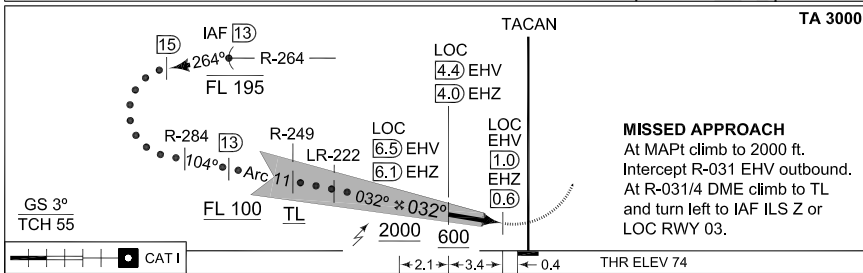

MISSED APPROACH

At MAPt climb to 2000 ft.
Intercept R-031 EHV outbound.
At R-031/4 DME climb to TL
and turn left to IAF ILS Z or
LOC RWY 03.

CATEGORY	C	D	E
S-ILS 03	274-800 200 (200-0.8)		288-800 214 (300-0.8)
S-LOC 03	420-800 346 (400-0.8)		420-1200 346 (400-1.2)
CIRCLING	NOT AUTHORIZED		

HI-ILS or LOC RWY 03

51°27.01'N
005°22.47'E

EINDHOVEN (EHEH)

CHANGES: EDITORIAL

MIPS

RNLASF 16 APR 2026

MIPS
INSTRUMENT APPROACH CHART

ILS Z or LOC RWY 03
EINDHOVEN (EHEH)

AD ELEV 74

DUTCH MIL 336.325 125.930		RAPCON SOUTH 388.525 123.180		EINDHOVEN TWR 241.550 131.005		GND CTL 335.750 121.930		ATIS* 126.030
LOCALIZER / DME EHZ 109.750 / CH 34Y		APP COURSE 032°	FAF ALT 2000 FT	GS 3°	DA SEE CAT	THR ELEV 74	ALS 892 m	LDA 9044 FT

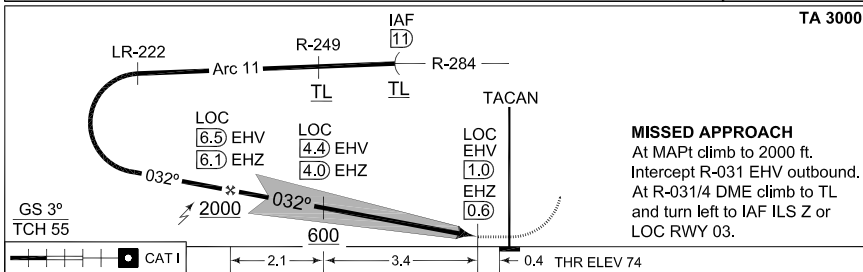
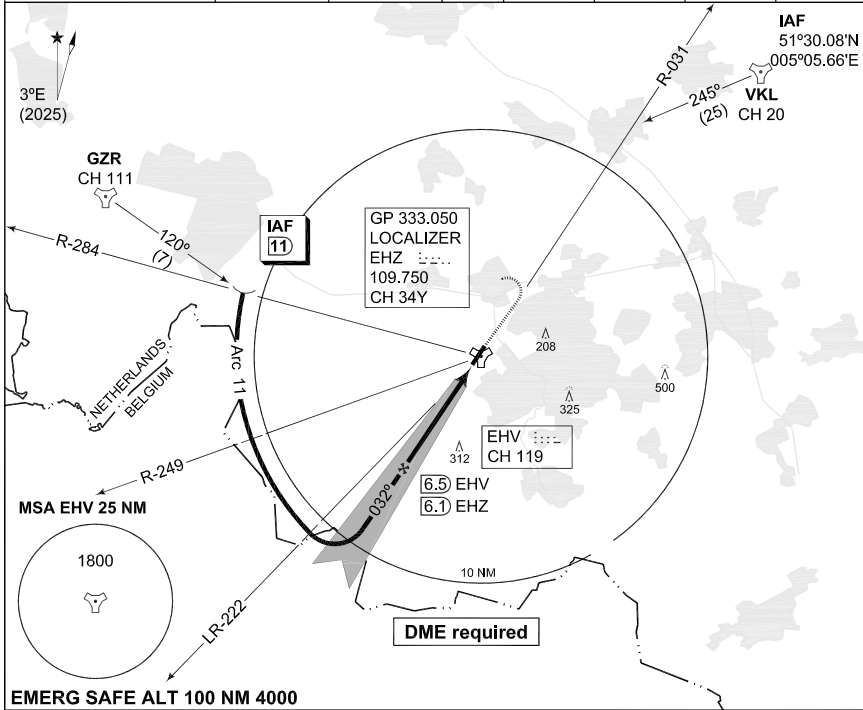

CATEGORY	A	B	C	D	E
S-ILS 03	274-800 200 (200-0.8)				288-800 214 (300-0.9)
S-LOC 03	420-800 346 (400-0.8)			420-1200 346 (400-1.2)	
CIRCLING	NOT AUTHORIZED				

ILS Z or LOC RWY 03

51°27.01'N
005°22.47'E

EINDHOVEN (EHEH)

CHANGES: EDITORIAL

MIPS

RNLASF 16 APR 2026

MIPS
INSTRUMENT APPROACH CHART

AD ELEV 74

HI-TACAN RWY 03
EINDHOVEN (EHEH)

DUTCH MIL 336.325 125.930		RAPCON SOUTH 388.525 123.180		EINDHOVEN TWR 241.550 131.005		GND CTL 335.750 121.930		ATIS* 126.030
TACAN EHV CH 119	APP COURSE 036°	FAF ALT 2000 FT	Descent GR	MDA 420	THR ELEV 74	ALS 892 m	LDA 9044 FT	

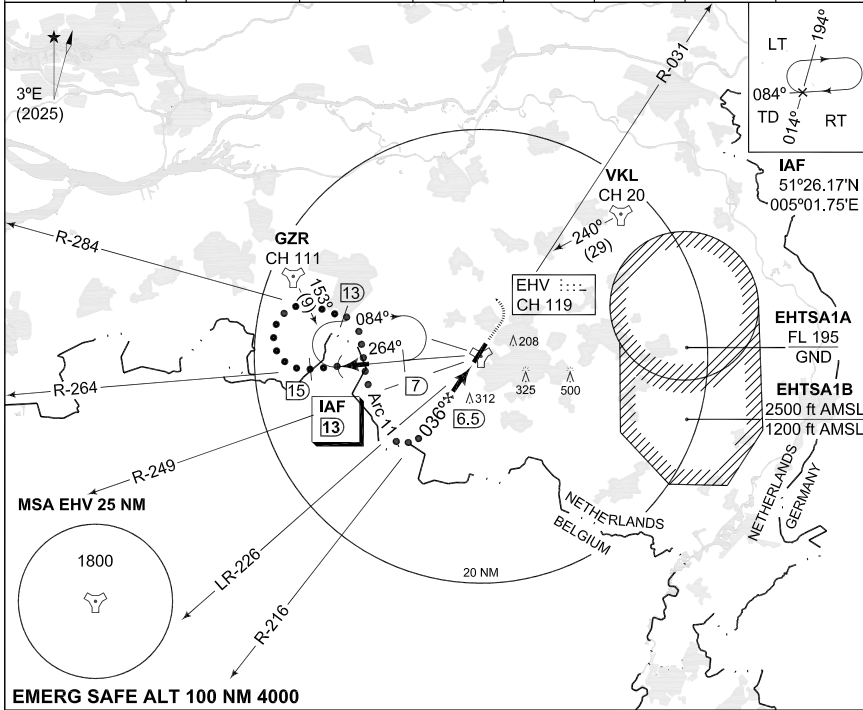

EMERG SAFE ALT 100 NM 4000

TA 3000

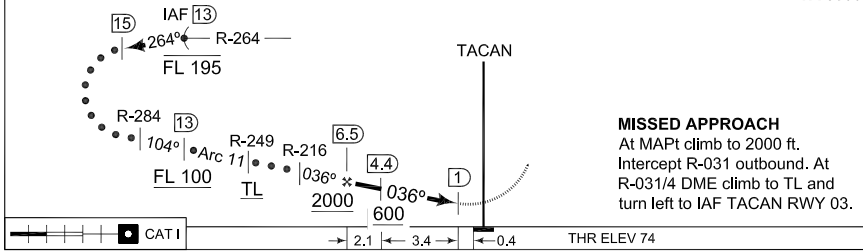

CATEGORY	C	D	E
S-TACAN 03	420-800 346 (400-0.8)	420-1200 346 (400-1.2)	
CIRCLING	NOT AUTHORIZED		

HI-TACAN RWY 03

51°27.01'N
005°22.47'E

EINDHOVEN (EHEH)

MIPS
INSTRUMENT APPROACH CHART

AD ELEV 74

TACAN RWY 03
EINDHOVEN (EHEH)

DUTCH MIL 336.325 125.930		RAPCON SOUTH 388.525 123.180		EINDHOVEN TWR 241.550 131.005		GND CTL 335.750 121.930		ATIS* 126.030
TACAN EHV CH 119		APP COURSE 036°	FAF ALT 2000 FT	Descent GR 5.24%	MDA 420	THR ELEV 74	ALS 892 m	LDA 9044 FT

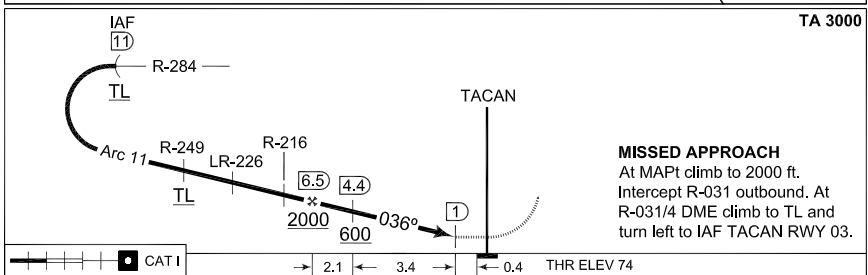
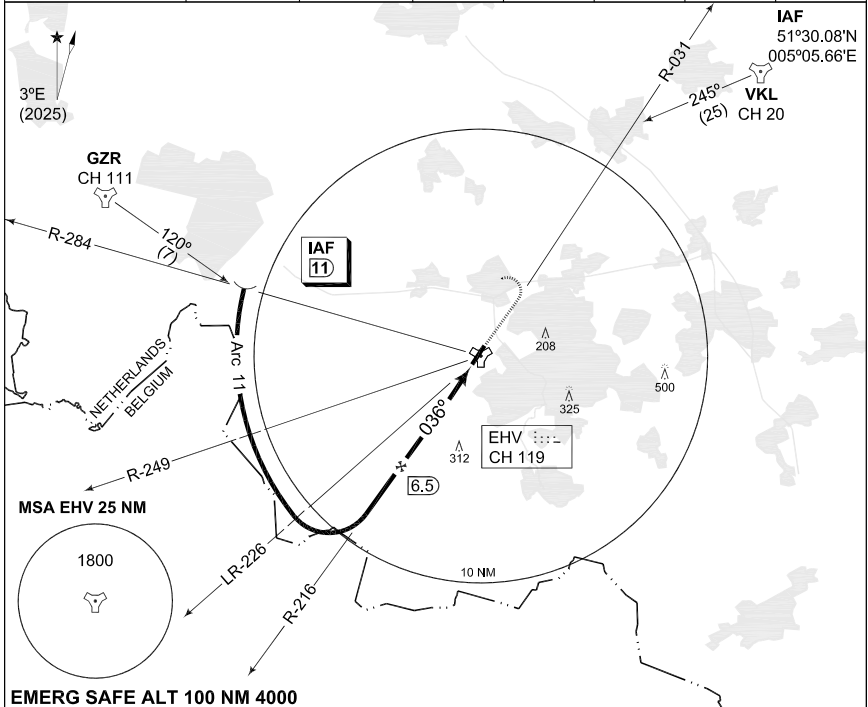

CATEGORY	A	B	C	D	E
S-TACAN 03	420-800 346 (400-0.8)			420-1200 346 (400-1.2)	
CIRCLING	NOT AUTHORIZED				

TACAN RWY 03

51°27.01'N
005°22.47'E

EINDHOVEN (EHEH)

CHANGES: EDITORIAL

RNLASF 16 APR 2026

**PANS OPS
INSTRUMENT APPROACH CHART**

**RNP Z RWY 03
EINDHOVEN (EHEH)**

AD ELEV 74

DUTCH MIL 336.325 125.930		RAPCON SOUTH 388.525 123.180		EINDHOVEN TWR 241.550 131.005		GND CTL 335.750 121.930		ATIS* 126.030	
EGNOS CHANNEL 89942 E03A	APP COURSE 032°	FAF ALT 2000 FT	Descent GR 5.24% / 3°	MDA 420	DA SEE CAT	THR ELEV 74	ALS 892 m	LDA 9044 FT	

NOTE:

- a) ALL DISTANCES ARE RELATED TO THRESHOLD
- b) MINIMUM TEMPERATURE -20°C

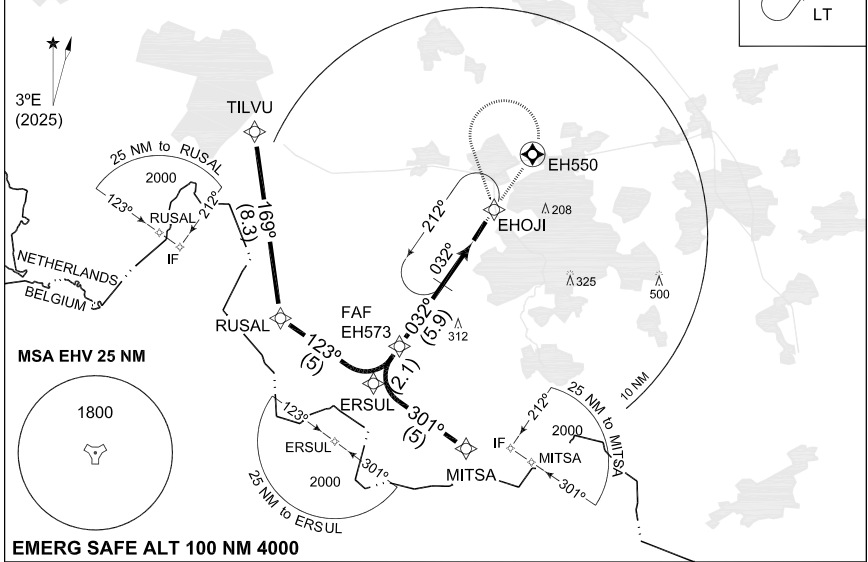
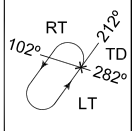

EMERG SAFE ALT 100 NM 4000

TA 3000

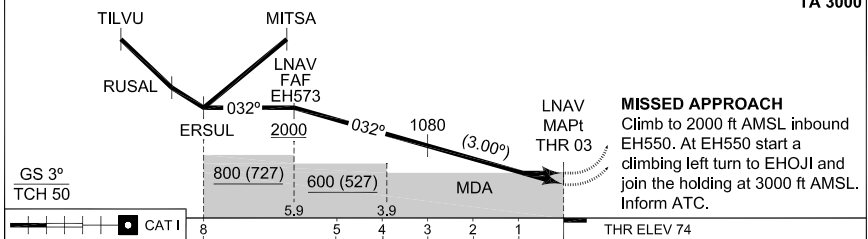

MISSED APPROACH

Climb to 2000 ft AMSL inbound EH550. At EH550 start a climbing left turn to EHOJI and join the holding at 3000 ft AMSL. Inform ATC.

CATEGORY		A	B	C	D		
EIL-OPS	DA(H) LPV	274 -550 200 (200-0.8/1.2)			278 -550 204 (300-0.8/1.2)		
	DA(H) LNAV / VNAV	324 -550 250 (300-0.8/1.3)			329 -600 255 (300-0.8/1.3)		
	MDA(H) LNAV	420 -900 346 (400-0.9/1.6)					
IAWP	TILVU	51°31.07'N	005°06.23'E	FAWP	EH573	51°21.63'N	005°16.46'E
WP	RUSAL	51°22.85'N	005°08.09'E	MAWP	THR 03	51°26.45'N	005°21.85'E
IAWP	MITSa	51°17.13'N	005°21.16'E	MATWP	EH550	51°30.21'N	005°26.06'E
IWP	ERSUL	51°19.91'N	005°14.54'E	HF	EHOJI	51°28.07'N	005°23.69'E

RNP Z RWY 03

51°27.01'N
005°22.47'E

EINDHOVEN (EHEH)

CHANGES: EDITORIAL

RNLASF 16 APR 2026

MIPS
INSTRUMENT APPROACH CHART

HI-ILS or LOC RWY 21
EINDHOVEN (EHEH)

AD ELEV 74

DUTCH MIL 336.325 125.930		RAPCON SOUTH 388.525 123.180		EINDHOVEN TWR 241.550 131.005		GND CTL 335.750 121.930		ATIS* 126.030
LOCALIZER / DME EHO 109.750 / CH 34Y		APP COURSE 212°	FAF ALT 2000 FT	GS 3°	DA SEE CAT	THR ELEV 67	ALS 869 m	LDA 9044 FT

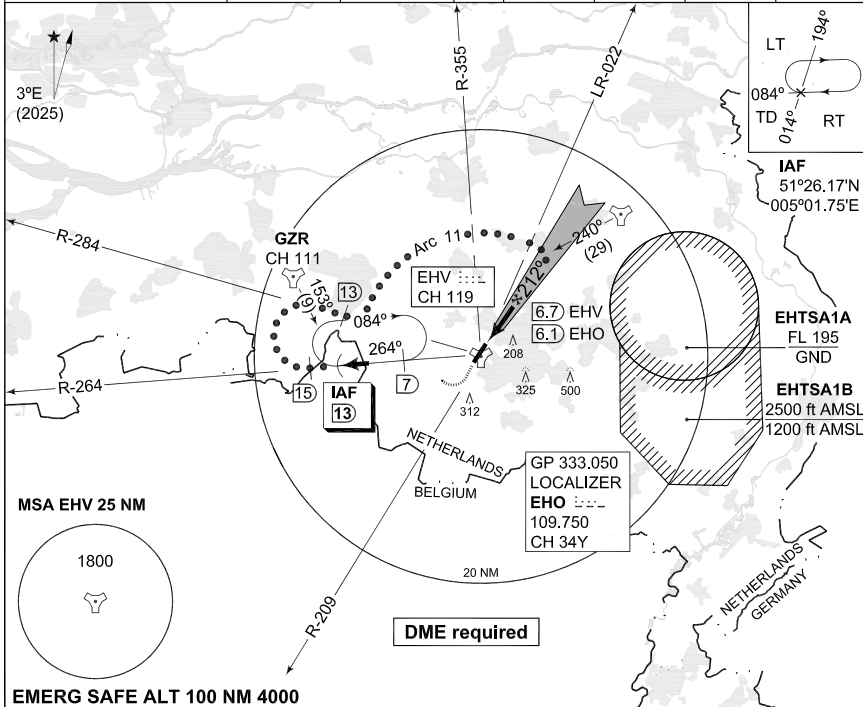

EMERG SAFE ALT 100 NM 4000

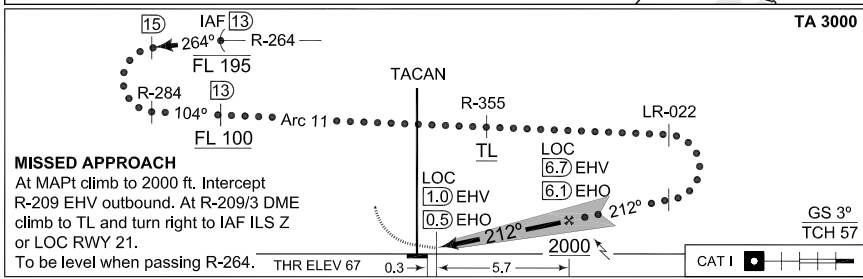

MISSED APPROACH

At MAPt climb to 2000 ft. Intercept R-209 EHV outbound. At R-209/3 DME climb to TL and turn right to IAF ILS Z or LOC RWY 21.
To be level when passing R-264.

CATEGORY	C	D	E
S-ILS 21	267-800 200 (200-0.8)		275-800 208 (300-0.8)
S-LOC 21	500-1200 433 (500-1.2)		500-1600 433 (500-1.6)
CIRCLING	NOT AUTHORIZED		

HI-ILS or LOC RWY 21

51°27.01'N
005°22.47'E

EINDHOVEN (EHEH)

CHANGES: EDITORIAL

MIPS

RNLASF 16 APR 2026

MIPS
INSTRUMENT APPROACH CHART

ILS Z or LOC RWY 21
EINDHOVEN (EHEH)

AD ELEV 74

DUTCH MIL 336.325 125.930		RAPCON SOUTH 388.525 123.180		EINDHOVEN TWR 241.550 131.005		GND CTL 335.750 121.930		ATIS* 126.030
LOCALIZER / DME EHO 109.750 / CH 34Y		APP COURSE 212°	FAF ALT 2000 FT	GS 3°	DA SEE CAT	THR ELEV 67	ALS 869 m	LDA 9044 FT

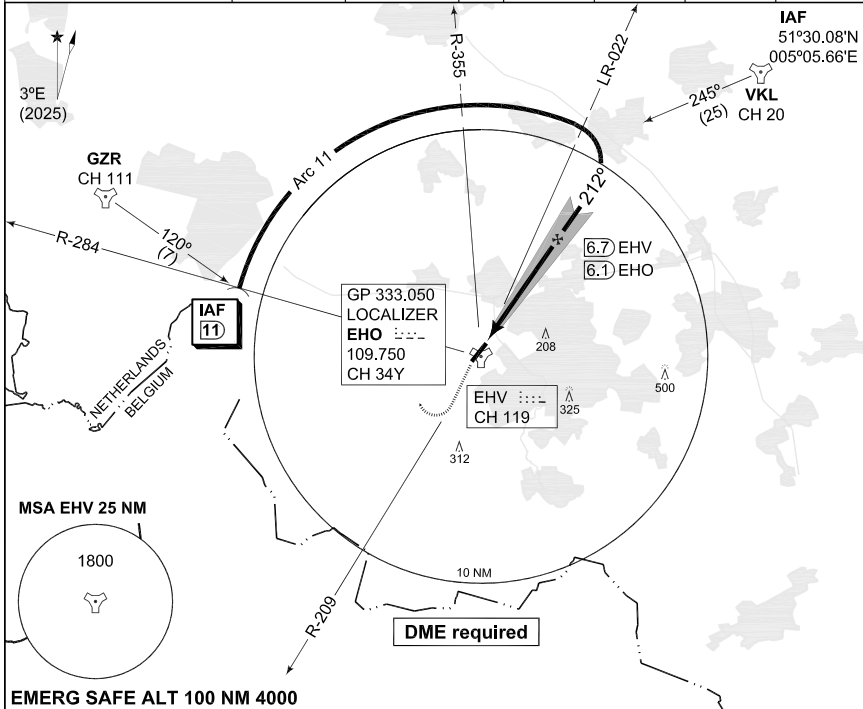

TA 3000

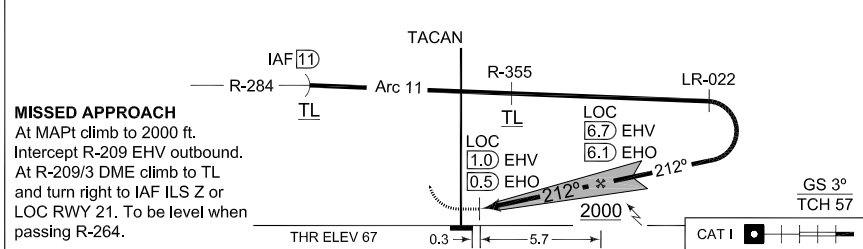

CATEGORY	A	B	C	D	E
S-ILS 21		267-800 200 (200-0.8)			275-800 208 (300-0.8)
S-LOC 21	500-800 433 (500-0.8)		500-1200 433 (500-1.2)	500-1600 433 (500-1.6)	
CIRCLING	NOT AUTHORIZED				

ILS Z or LOC RWY 21

51°27.01'N
005°22.47'E

EINDHOVEN (EHEH)

CHANGES: EDITORIAL

MIPS

RNLASF 16 APR 2026

MIPS
INSTRUMENT APPROACH CHART

HI-TACAN RWY 21
EINDHOVEN (EHEH)

AD ELEV 74

DUTCH MIL 336.325 125.930		RAPCON SOUTH 388.525 123.180		EINDHOVEN TWR 241.550 131.005		GND CTL 335.750 121.930		ATIS* 126.030
TACAN EHV CH 119	APP COURSE 209°	FAF ALT 2000 FT	Descent GR 5.24%	MDA 500	THR ELEV 67	ALS 869 m	LDA 9044 FT	

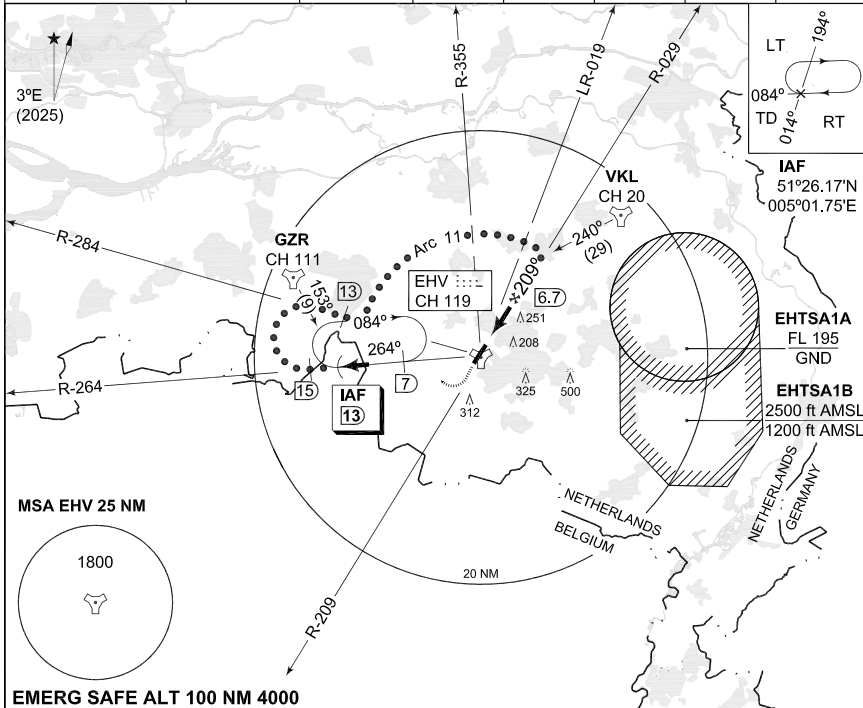

EMERG SAFE ALT 100 NM 4000

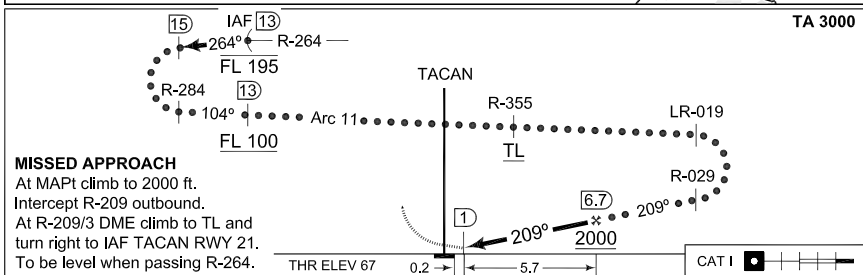

CATEGORY	C	D	E
S-TACAN 21	500-1200 433 (500-1.2)	500-1600 433 (500-1.6)	
CIRCLING	NOT AUTHORIZED		

HI-TACAN RWY 21

51°27.01'N
005°22.47'E

EINDHOVEN (EHEH)

MIPS
INSTRUMENT APPROACH CHART

TACAN RWY 21
EINDHOVEN (EHEH)

AD ELEV 74

DUTCH MIL 336.325 125.930		RAPCON SOUTH 388.525 123.180		EINDHOVEN TWR 241.550 131.005		GND CTL 335.750 121.930		ATIS* 126.030
TACAN EHV CH 119	APP COURSE 209°	FAF ALT 2000 FT	Descent GR 5.24%	MDA 500	THR ELEV 67	ALS 869 m	LDA 9044 FT	

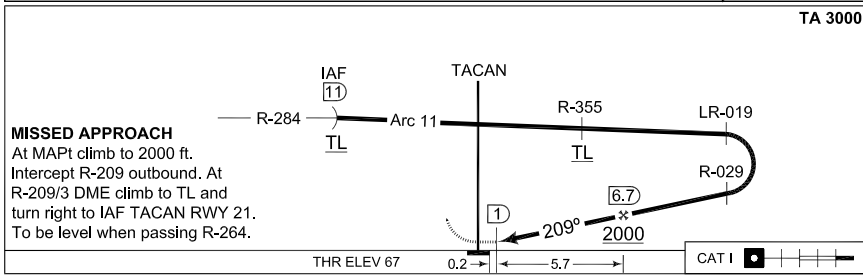
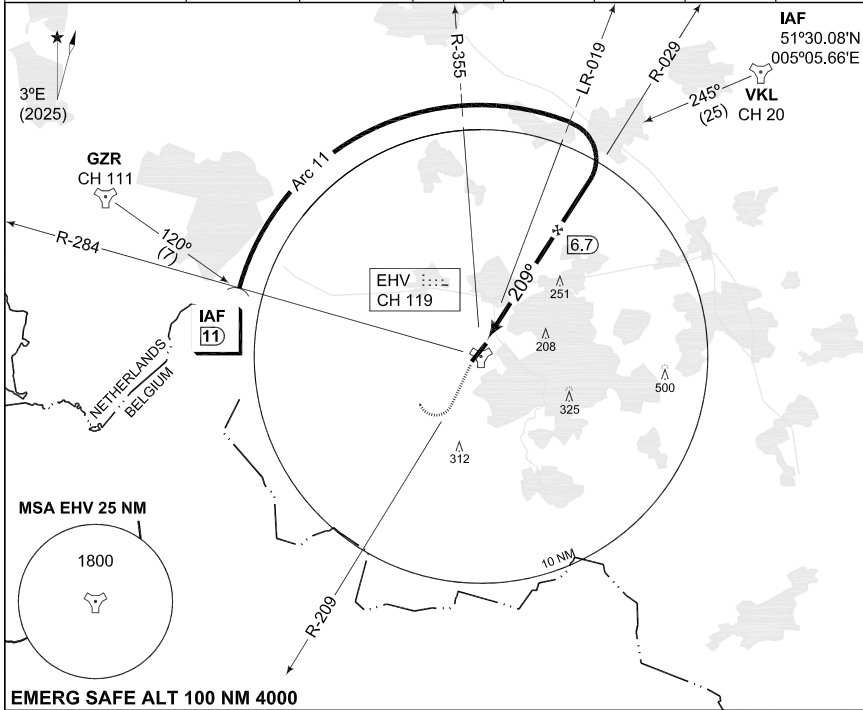

CATEGORY	A	B	C	D	E
S-TACAN 21	500-800 433 (500-0.8)		500-1200 433 (500-1.2)	500-1600 433 (500-1.6)	
CIRCLING	NOT AUTHORIZED				

TACAN RWY 21

51°27.01'N
005°22.47'E

EINDHOVEN (EHEH)

CHANGES: EDITORIAL
MIPS

RNLASF 16 APR 2026

**PANS OPS
INSTRUMENT APPROACH CHART**

AD ELEV 74

**RNP Z RWY 21
EINDHOVEN (EHEH)**

DUTCH MIL 336.325 125.930		RAPCON SOUTH 388.525 123.180		EINDHOVEN TWR 241.550 131.005		GND CTL 335.750 121.930		ATIS* 126.030	
EGNOS CHANNEL 42264 E21A	APP COURSE 212°	FAF ALT 2000 FT	Descent GR 5.24% / 3°	MDA 450	DA SEE CAT	THR ELEV 67	ALS 869 m	LDA 9044 FT	

NOTE:

- a) ALL DISTANCES ARE RELATED TO THRESHOLD
- b) MINIMUM TEMPERATURE -20°C

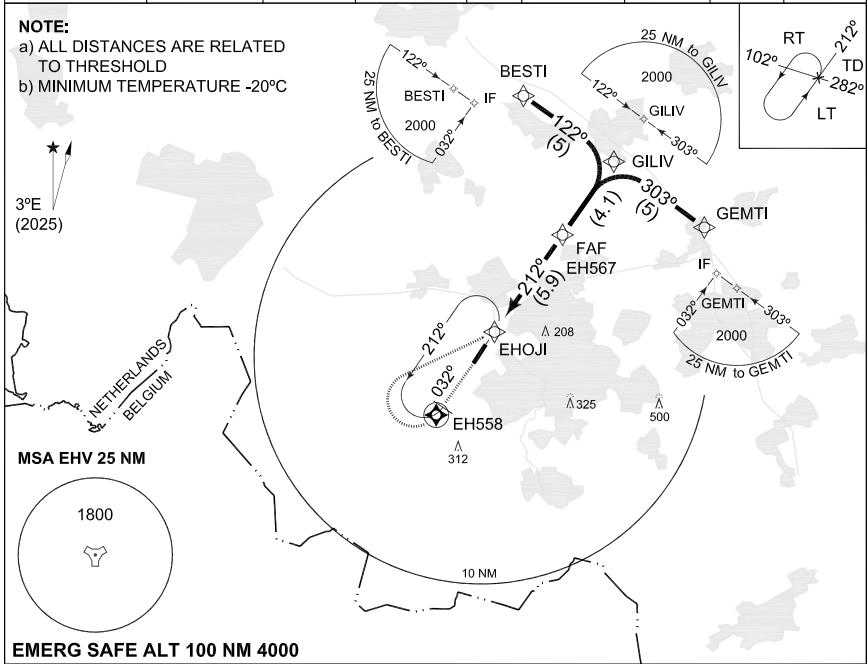

EMERG SAFE ALT 100 NM 4000

MISSED APPROACH

Climb to 2000 ft AMSL inbound EH558. At EH558 start a climbing right turn to EHOJI and join the holding at 3000 ft AMSL. Inform ATC.

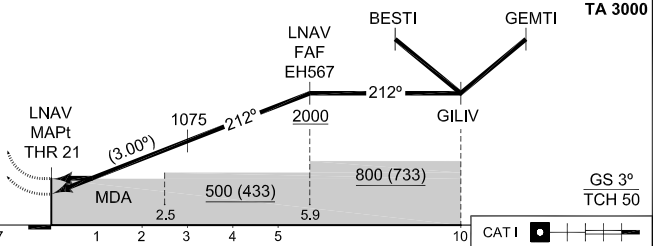

CATEGORY		A	B	C	D
EU-OPS	DA(H) LPV	278-550 211 (300-0.8/1.2)	288-550 221 (300-0.8/1.2)	298-550 231 (300-0.8/1.2)	308-550 241 (300-0.8/1.3)
	DA(H) LNAV / VNAV	334-600 267 (300-0.8/1.3)	344-600 277 (300-0.8/1.3)	354-650 287 (300-0.8/1.4)	364-650 297 (300-0.8/1.4)
	MDA(H) LNAV	450-1100 383 (400-1.1/1.8)			

IAWP	BESTI	51°38.54'N	005°25.66'E	MAWP	THR 21	51°27.56'N	005°23.09'E
IAWP	GEMTI	51°32.80'N	005°38.77'E	MATWP	EH558	51°24.48'N	005°19.65'E
IWP	GILIV	51°35.74'N	005°32.29'E	HF	EHOJI	51°28.07'N	005°23.69'E
FAWP	EH567	51°32.40'N	005°28.53'E				

RNP Z RWY 21

51°27.01'N
005°22.47'E

EINDHOVEN (EHEH)

CHANGES: EDITORIAL

RNLASF 16 APR 2026

AERODROME CHART

ESBJERG (EKEB)

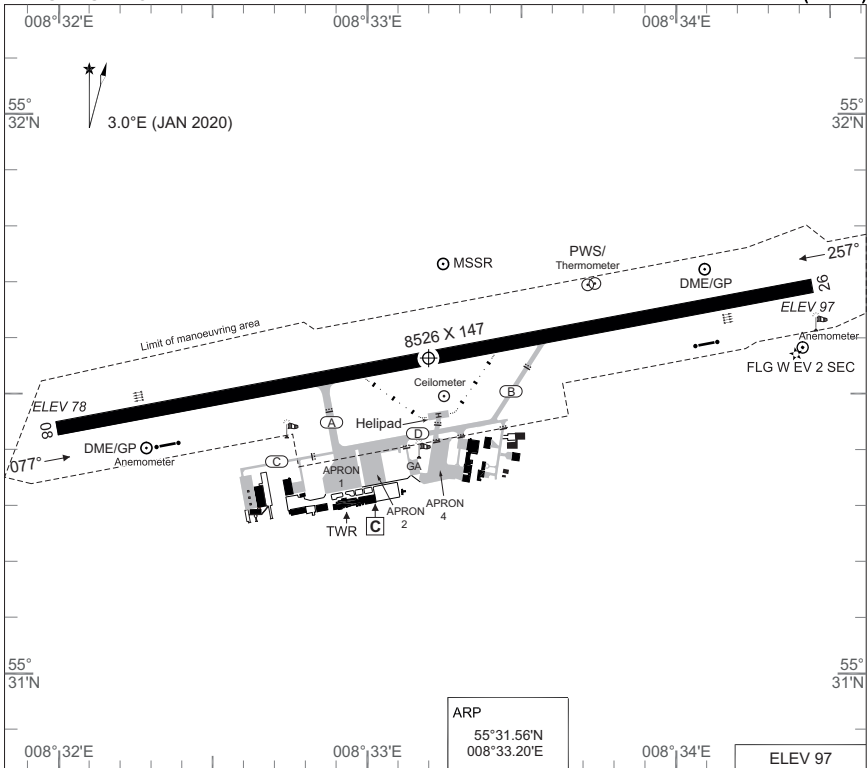

RWY	PCN	DECLARED DISTANCES					PAPI	THR ELEV	THR PSN		
		PSN	TORA	TODA	ASDA	LDA					
08	60 F/A/W/T		8526	8526	8526	8526	3°	79	55°31.43'N 008°32.01'E		
		A	5479	5479	5479						
		B	3021	3021	3021						
26				8526	8526	8526	8526	3°		97	55°31.69'N 008°34.44'E
		B	5410	5410	5410						
		A	2969	2969	2969						

ESBJERG INFORMATION 120.155

Flight procedures:

- Aircraft will normally be cleared by ACC Copenhagen to TOMMO HLDG.
- Navigation fix designated for radio communication failure during IMC is: TOMMO

- Omnidirectional departures:

RWY 08/26: Climb straight ahead to at least 500 FT AMSL before turn is commenced.

	PROC. CRITERIA	RWY	GS	TCH	OTCH	RPI	CAT	MINIMA CRITERIA	MINIMA
PAR	INTENTIONALLY LEFT BLANK								
SRA	INTENTIONALLY LEFT BLANK								

AERODROME CHART

ESBJERG (EKEB)

CHANGES: ARRIVAL & COMMUNICATION FAILURE PROCEDURES CHANGED.

AIR COMMAND DENMARK - MIL AIN 20 MAR 2025

MIPS

INSTRUMENT APPROACH CHART

AD ELEV 97

**ILS Y or LOC Y RWY 08
ESBJERG (EKEB)**

COPENHAGEN CONTROL 362.750 136.555		BILLUND ATIS 118.780		BILLUND APPROACH 127.580		ESBJERG INFORMATION 120.155	
LOC OO 109.10	DME ES CH38y	APP COURSE 077°	GS INTCP ALT 2000 FT	GS 3.00°	DA 278	THR ELEV 78	ALS LENGTH 900 M
						LDA 8526 FT	

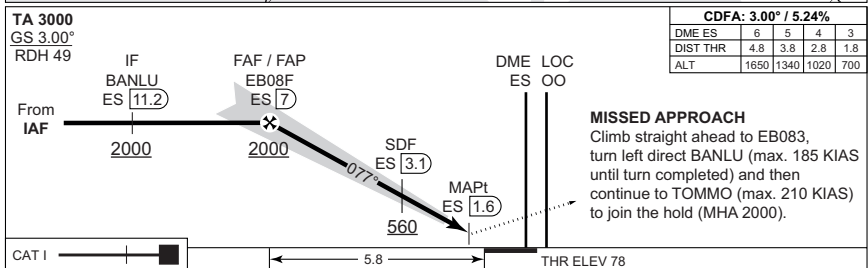
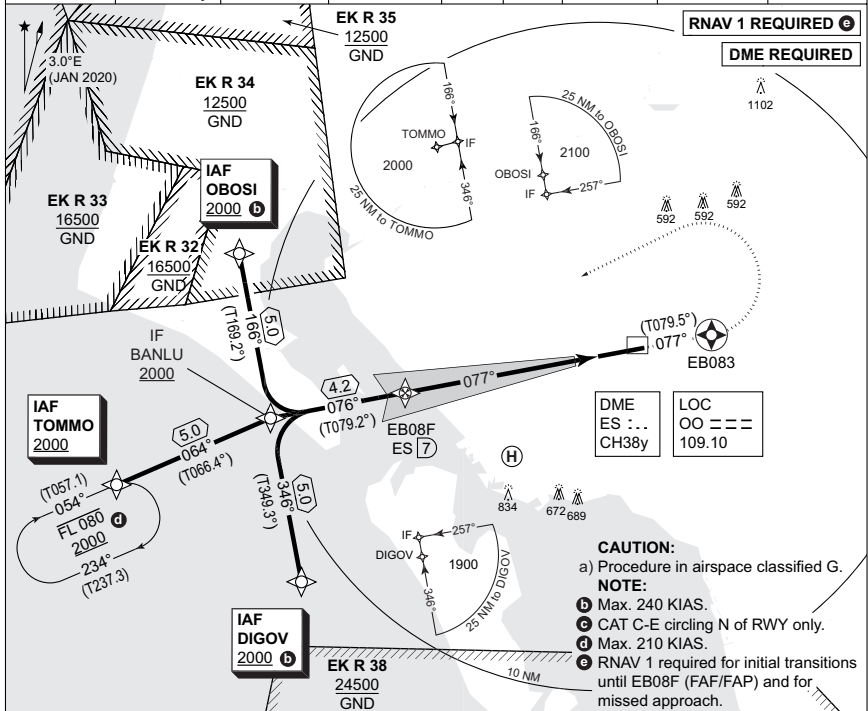

CATEGORY	A	B	C	D	E
S-ILS CAT I	278 - 550 200 (200-0.8/1.2)				
S-LOC 08	460 - 1100 382 (400-1.1/1.8)				
CIRCLING c	590 -1.5 493 (500-1.5)	600 -1.6 503 (600-1.6)	840 -2.4 743 (800-2.4)	990 -3.6 893 (900-3.6)	1090 -3.6 993 (1000-3.6)

ILS Y or LOC Y RWY 08

55°31.56'N
008°33.20'E

ESBJERG (EKEB)

CHANGES: EDITORIAL

AIR COMMAND DENMARK - MIL A1M 16 APR 2028

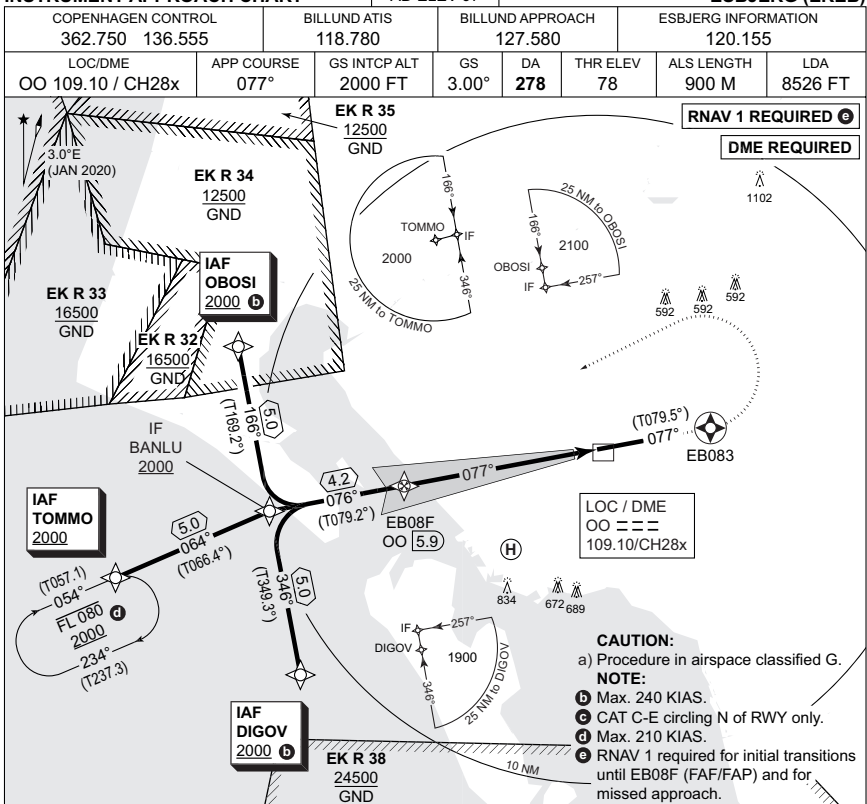

TA 3000
GS 3.00°
RDH 49

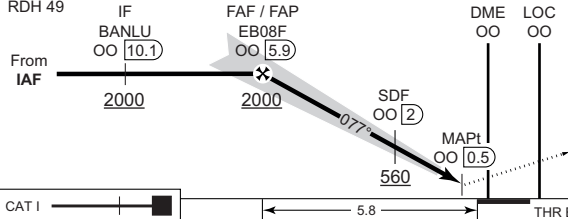

MISSED APPROACH
Climb straight ahead to EB083, turn left direct BANLU (max. 185 KIAS until turn completed) and then continue to TOMMO (max. 210 KIAS) to join the hold (MHA 2000).

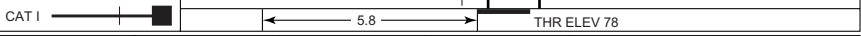

CATEGORY	A	B	C	D	E
S-ILS CAT I	278 - 550 200 (200-0.8/1.2)				
S-LOC 08	460 - 1100 382 (400-1.1/1.8)				
CIRCLING c	590 -1.5 493 (500-1.5)	600 -1.6 503 (600-1.6)	840 -2.4 743 (800-2.4)	990 -3.6 893 (900-3.6)	1090 -3.6 993 (1000-3.6)

MIPS

INSTRUMENT APPROACH CHART

AD ELEV 97

**ILS Y or LOC Y RWY 26
ESBJERG (EKEB)**

COPENHAGEN CONTROL 362.750 136.555		BILLUND ATIS 118.780		BILLUND APPROACH 127.580		ESBJERG INFORMATION 120.155	
LOC ES 110.15	DME OO 28x	APP COURSE 257°	GS INTCP ALT 2000 FT	GS 3.00°	DA 297	THR ELEV 97	LDA 8526 FT

CAUTION:

a) Procedure in airspace classified G.

NOTE:

- b) Max. 240 KIAS.
- c) CAT C-E circling N of RWY only.
- d) Max. 210 KIAS.
- e) RNAV 1 required for initial transitions until EB26F (FAF/FAP) and for missed approach.

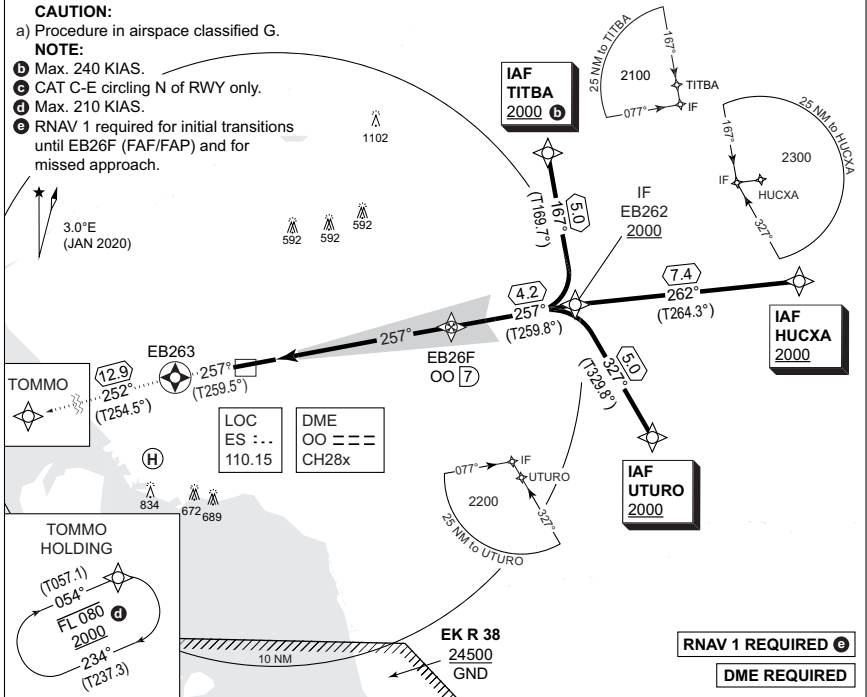

RNAV 1 REQUIRED
DME REQUIRED

CDFA: 3.00° / 5.24%				
DME OO	3	4	5	6
DIST THR	1.8	2.8	3.8	4.8
ALT	710	1030	1350	1660

TA 3000
GS 3.00°
RDH 51

MISSED APPROACH

Climb straight ahead to EB263, turn left to TOMMO to join the hold (MHA 2000).

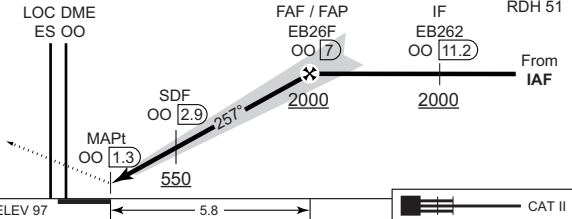

CATEGORY	A	B	C	D	E
S-ILS CAT I			297 - 550 200 (200-0.8/1.2)		
S-LOC 26			430 - 800 333 (400-0.8/1.5)		
CIRCLING	590 -1.5 493 (500-1.5)	600 -1.6 503 (600-1.6)	840 -2.4 743 (800-2.4)	990 -3.6 893 (900-3.6)	1090 -3.6 993 (1000-3.6)

ILS 8 Y or LOC Y RWY 26

55°31.56'N
008°33.20'E

ESBJERG (EKEB)

CHANGES: EDITORIAL

AIR COMMAND DENMARK - MIL-AIM 16 APR 2026

MIPS

INSTRUMENT APPROACH CHART

AD ELEV 97

ILS Z or LOC Z RWY 26
ESBJERG (EKEB)

COPENHAGEN CONTROL 362.750 136.555		BILLUND ATIS 118.780	BILLUND APPROACH 127.580	ESBJERG INFORMATION 120.155		
LOC/DME ES 110.15 / CH38y	APP COURSE 257°	GS INTCP ALT 2000 FT	GS 3.00°	DA 297	THR ELEV 97	LDA 8526 FT

CAUTION:

a) Procedure in airspace classified G.

NOTE:

- b) Max. 240 KIAS.
- c) CAT C-E circling N of RWY only.
- d) Max. 210 KIAS.
- e) RNAV 1 required for initial transitions until EB26F (FAF/FAP) and for missed approach.

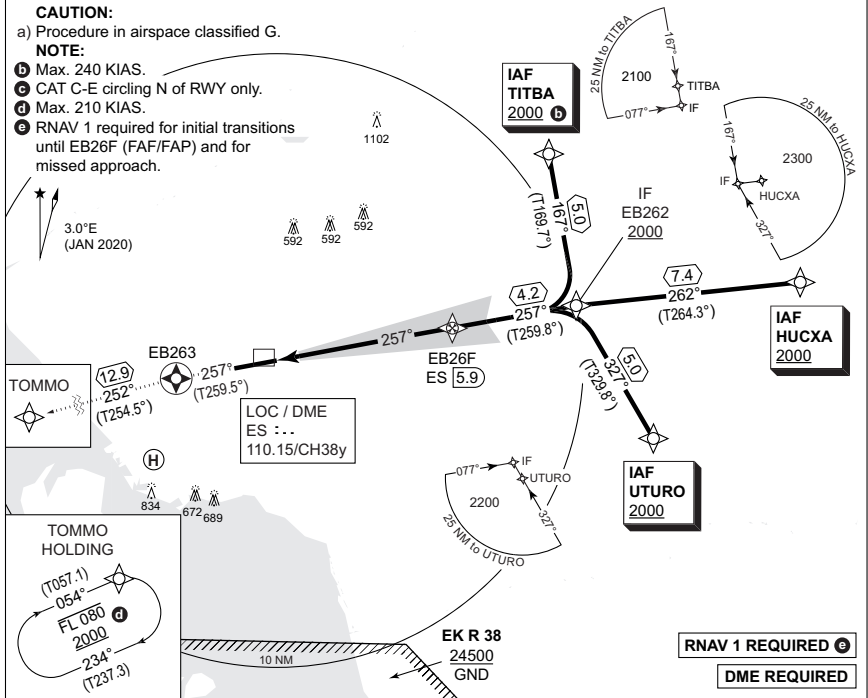

CDFA: 3.00° / 5.24%				
DME ES	2	3	4	5
DIST THR	1.8	2.8	3.8	4.8
ALT	730	1050	1360	1680

TA 3000
GS 3.00°
RDH 51

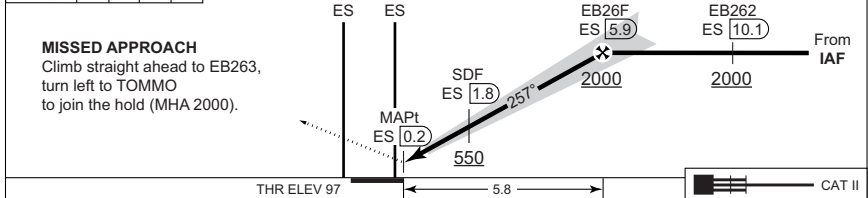

THR ELEV 97 5.8 CAT II

CATEGORY	A	B	C	D	E
S-ILS CAT I		297 - 550 200 (200-0.8/1.2)			
S-LOC 26		430 - 800 333 (400-0.8/1.5)			
CIRCLING e	590 -1.5 493 (500-1.5)	600 -1.6 503 (600-1.6)	840 -2.4 743 (800-2.4)	990 -3.6 893 (900-3.6)	1090 -3.6 993 (1000-3.6)

ILS Z or LOC Z RWY 26

55°31.56'N
008°33.20'E

ESBJERG (EKEB)

CHANGES: EDITORIAL

AIR COMMAND DENMARK - MIL-AIM 16 APR 2026

AERODROME CHART

EVENES (ENEV)

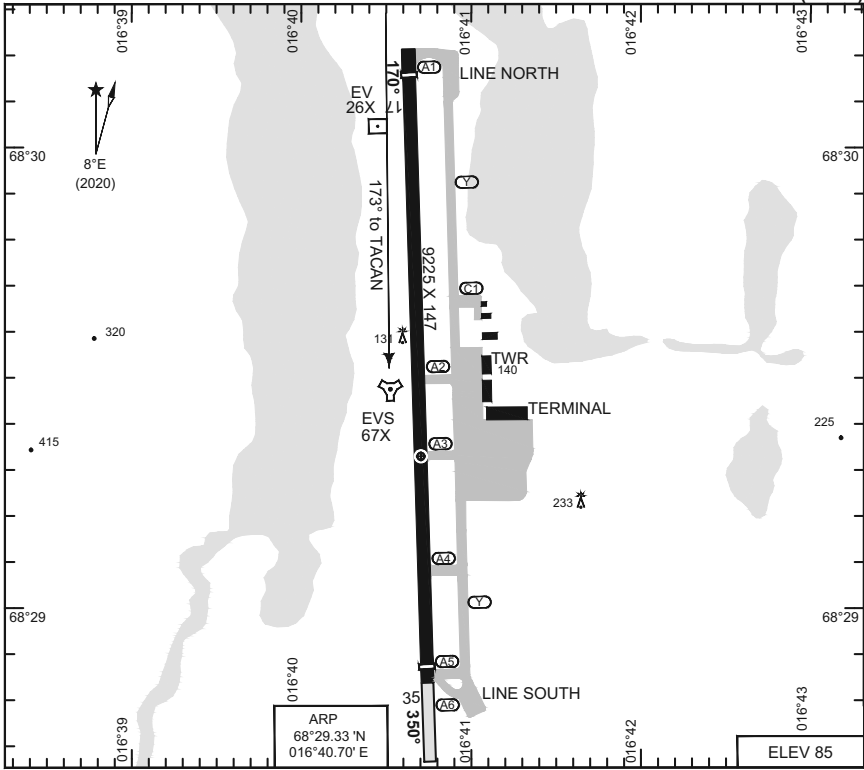

RWY	PCN	TORA	ASDA	TODA	LDA	PAPI	THR ELEV	THR PSN
17	65 F/A/W/U	9225	9225	10144	8917	3.4°	82	68°30.18' N - 016°40.61' E
35	65 F/A/W/U	9225	9225	10006	9028	3.5°	81	68°28.76' N - 016°40.77' E

ATIS 126.030
 EVENES TWR 118.005 120.105 308.775 257.800
 DE-ICE 121.780

CHANGES: FREQUENCIES.

RNSAF 30 OCT 2025

AERODROME CHART

EVENES (ENEV)

MIPS
INSTRUMENT DEPARTURE CHART

HPMA SID RWY 17 / 35
EVENES (ENEV)

ATIS 126.030	EVENES TWR 118.005 120.105 308.775 257.800			EVENES APP 120.105 369.325				POLARIS CONTROL 126.455 278.050				
AD ELEV 85	RWY 17 / 35	MIN CLIMB 8.75%	GS (kt) 5.0°	V/V (fpm)	60	120	180	240	300	360	to	reason
					540	1070	1600	2130	2660	3190	7000	HPMA

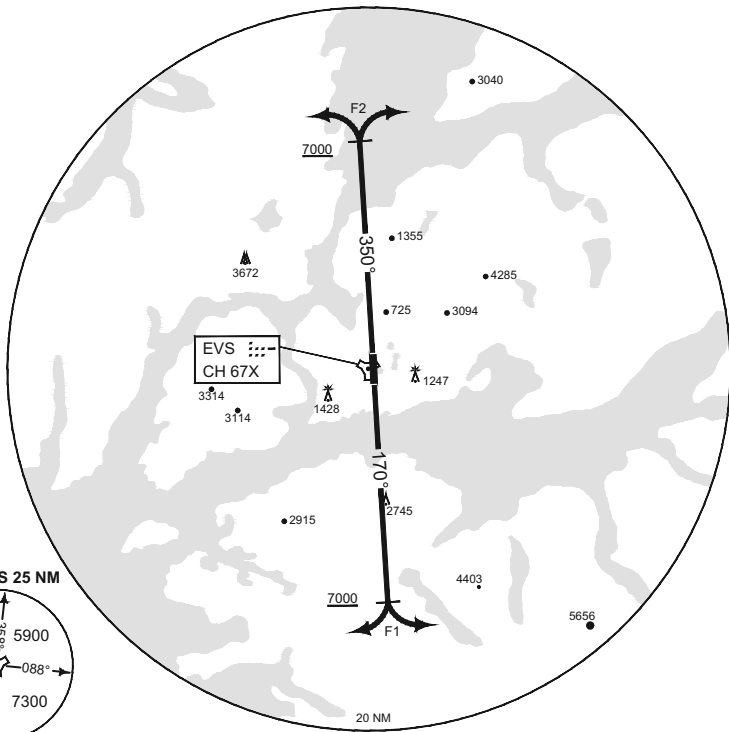

MSA EVS 25 NM

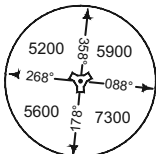

EMERG SAFE ALT 100 NM 9000

TA 7000

HPMA F1
(RWY 17)

- Climb track 170°. Passing 7000 ft turn according to ATC clearance, and continue climb to FL 090.
- Maximum 450 KIAS.

HPMA F2
(RWY 35)

- Climb track 350°. Passing 7000 ft turn according to ATC clearance, and continue climb to FL 090.
- Maximum 450 KIAS.

CHANGES: POLARIS CONTROL FREQUENCIES.

RNAAF 25 DEC 2025

HPMA SID RWY 17 / 35

68°29.33' N
016°40.70' E

EVENES (ENEV)

**MIPS
INSTRUMENT DEPARTURE CHART**

**TACAN SID RWY 17 / 35
EVENES (ENEV)**

ATIS 126.030	EVENES TWR 118.005 120.105 308.775 257.800			EVENES APP 120.105 369.325			POLARIS CONTROL 126.455 278.050			
AD ELEV 85		RWY	GS (kt)	FROM-TO	60	120	180	240	300	REASON
		17	V/V (fpm)	DER-3500	420	830	1240	1660	2070	TERRAIN
		35	V/V (fpm)	DER-1000	340	680	1020	1370	1710	
			V/V (fpm)	1000-1800	230	450	680	900	1130	

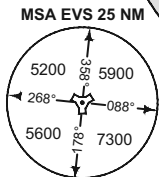
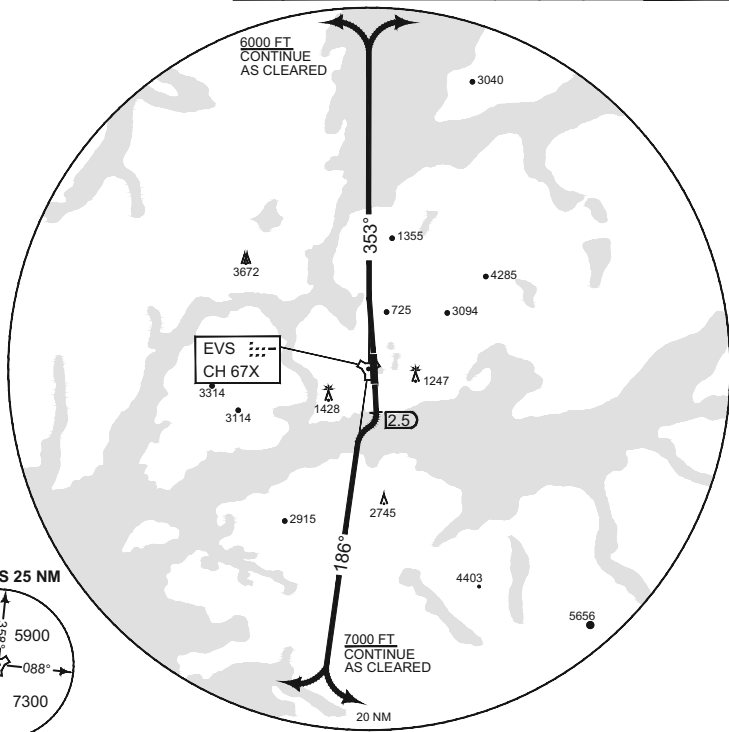

EMERG SAFE ALT 100 NM 9000 **TA 7000**

RWY 17	<ul style="list-style-type: none"> - Climb to FL 90. Maximum 300 KIAS. - Minimum climb gradient 6.8% (3.9°) to 3500 ft. - Climb straight ahead to EVS 2.5 DME, then turn right to intercept EVS R-186 outbound. Climb to 7000 ft before turning according to ATC clearance.
RWY 35	<ul style="list-style-type: none"> - Climb to FL 90. Maximum 300 KIAS. - Minimum climb gradient 5.6% (3.2°) to 1000 ft, then 3.7% (2.2°) to 1800 ft. - Climb straight ahead and intercept EVS R-353 outbound. Climb to 6000 ft before turning according to ATC clearance.

CHANGES: POLARIS CONTROL FREQUENCIES

RNOAF 25 DEC 2025

MIPS
INSTRUMENT APPROACH CHART

HPMA TACAN RWY 17
EVENES (ENEV)

AD ELEV 85

ATIS 126.030	EVENES APPROACH 120.105 369.325		EVENES TOWER 118.005 120.105 308.775 257.800				
TACAN EVS CH 67X	APP COURSE 173°	FAF ALT 2400	Descent GR 3.4°	MDA 1010	THR ELEV 82	ALS 720 m	LDA 8917

CAUTION:

a) FINAL OFFSET 3° EAST OF RWY CENTERLINE.

● CIRCLING NOT AUTHORIZED EAST OF RWY.

NOTE:

c) VSS PENETRATED E OF FINAL 2.8 NM FM THR 17.

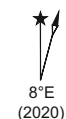

MSA EVS 25 NM

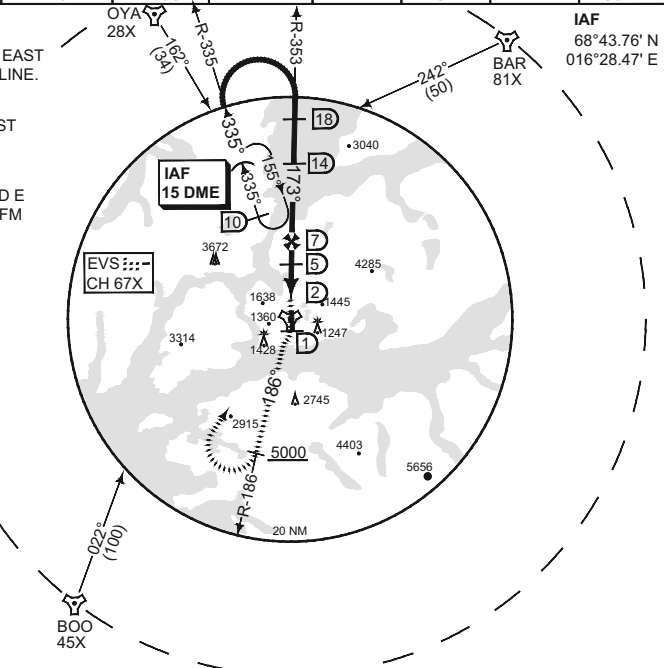
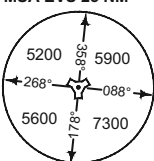

IAF
68°43.76' N
016°28.47' E

EMERG SAFE ALT 100NM 9000

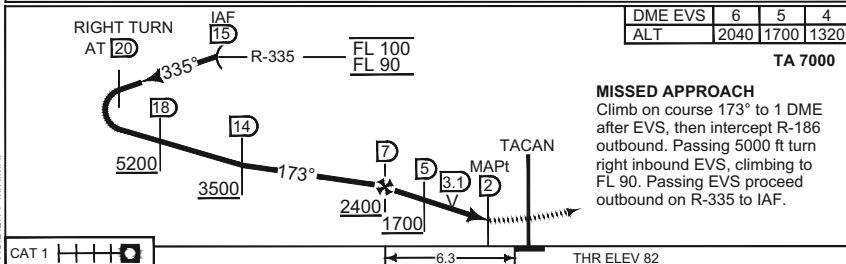

DME EVS	6	5	4
ALT	2040	1700	1320

TA 7000

MISSED APPROACH

Climb on course 173° to 1 DME after EVS, then intercept R-186 outbound. Passing 5000 ft turn right inbound EVS, climbing to FL 90. Passing EVS proceed outbound on R-335 to IAF.

CAT 1	6.3	THR ELEV 82
-------	-----	-------------

HPMA	
CATEGORY	HPMA
S-TAC 17	1010 - 3.6 928 (1000 - 3.6/4.3)
● CIRCLING	1990 - 5.0 1905 (2000 - 5.0)

HPMA TACAN RWY 17

68°29.33N
016°40.70E

EVENES (ENEV)

CHANGES: FREQUENCIES, VISIBILITY MINIMA

RNO/AF 30 OCT 2025

MIPS INSTRUMENT APPROACH CHART

AD ELEV 85

ILS M or LOC M RWY 17 EVENES (ENEV)

ATIS 126.030	EVENES APPROACH 120.105 369.325		EVENES TOWER 118.005 120.105 308.775 257.800				
LOCALIZER/DME EV 108.900 / CH 26X	APP COURSE 170°	GS INTCP ALT 3500	GS 3.8°	DA SEE CAT	THR ELEV 82	ALS 720 m	LDA 8917

CAUTION:
 ● CIRCLING NOT AUTHORIZED EAST OF RWY 17 / 35.
 b) STEEP FINAL APPROACH.

NOTE:
 c) DME REQUIRED.
 d) DME FROM EVS UNLESS INDICATED OTHERWISE.
 e) PAPI 3.4°

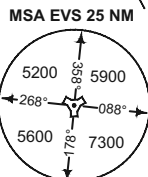
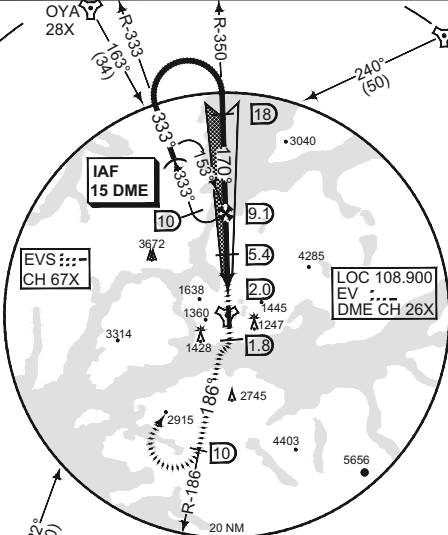

EMERG SAFE ALT 100 NM 9000

DME	8	7	6	5	4	3	2
ALT EVS	3120	2700	2290	1880	1470	1060	650
ALT EV	3360	2940	2520	2110	1700	1290	880

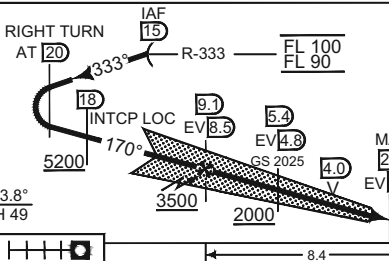

MISSED APPROACH TA 7000
 Climb on track 169°. At 1.8 DME after EVS / EV 2.4 DME turn right (max 185 kt) and intercept R-186 outbound climbing to FL 90. Passing 5000 ft or EVS 10 DME, whichever occurs first, turn right direct EVS. Passing EVS proceed on R-333 outbound to IAF.

CAT 1	8.4		THR ELEV 82
-------	-----	--	-------------

CATEGORY	A	B	C	D
S-ILS 17	1345 - 5.0 1263 (1300 - 5.0/5.0)	1363 - 5.0 1281 (1300 - 5.0/5.0)	1375 - 5.0 1293 (1300 - 5.0/5.0)	1391 - 5.0 1309 (1400 - 5.0/5.0)
2.5% MA CLMB				
S-ILS 17	352 - 600 270 (300 - 0.8/1.3)	371 - 650 289 (300 - 0.8/1.4)	383 - 700 301 (400 - 0.8/1.4)	398 - 750 316 (400 - 0.8/1.4)
5.0% MA CLMB				
S-LOC 17	1480 - 5.0 1398 (1400 - 5.0/5.0)	1500 - 5.0 1418 (1500 - 5.0/5.0)	1530 - 5.0 1448 (1500 - 5.0/5.0)	1540 - 5.0 1458 (1500 - 5.0/5.0)
2.5% MA CLMB				
● CIRCLING	1480 - 5.0 1395 (1400 - 5.0)	1690 - 5.0 1605 (1700 - 5.0)	2090 - 5.0 2005 (2100 - 5.0)	2140 - 5.0 2055 (2100 - 5.0)

ILS M or LOC M RWY 17

68°29.33N
016°40.70E

EVENES (ENEV)

CHANGES: FREQUENCIES, EDITORIALS.

RN04AF 30 OCT 2025

MIPS
INSTRUMENT APPROACH CHART

HPMA TACAN RWY 35
EVENES (ENEV)

AD ELEV 85

ATIS 126.030	EVENES APPROACH 120.105 369.325			EVENES TOWER 118.005 120.105 308.775 257.800			
TACAN EVS CH 67X	APP COURSE 347°	FAF ALT 3300	Descent GR ● 4.8°	MDA 740	THR ELEV 81	ALS 600 m	LDA 9028

WARNING:

● VERY STEEP FINAL APPROACH. DECENT GRADIENT EXCEEDS MAXIMUM SPECIFIED IN AATCP-1.

CAUTION:

- CIRCLING NOT AUTHORIZED EAST OF RWY 35 / 17.
- c) DO NOT USE PAPI RWY 35 OUTSIDE 5 NM.
- d) FINAL OFFSET 3° EAST.

IAF
68°15.04' N
016°30.08' E

8°E
(2020)

MSA EVS 25 NM

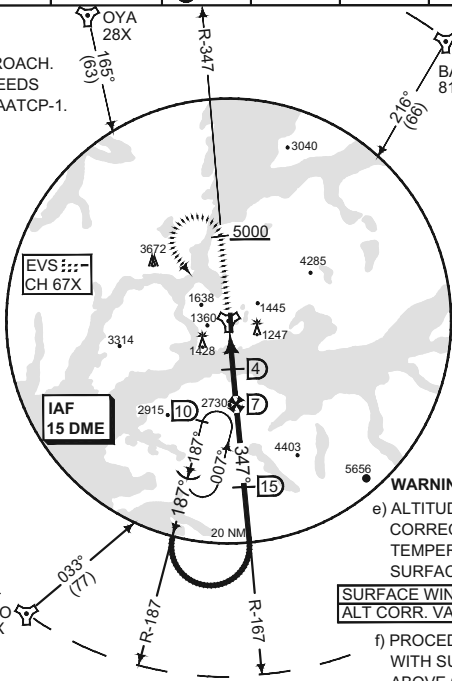
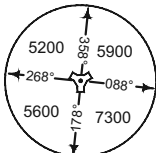

WARNING:

e) ALTITUDES MUST BE CORRECTED FOR LOW TEMPERATURE AND HIGH SURFACE WIND VELOCITY.

SURFACE WIND (kts)	20	40	60
ALT CORR. VALUE	50	200	450

f) PROCEDURE NOT AUTH. WITH SURFACE WIND ABOVE 60 KTS.

SAFE ALT 100NM 9000

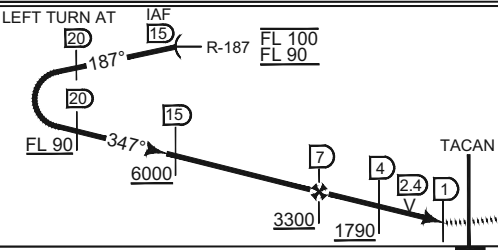

DME EVS	6	5	4	3	2
ALT	2800	2290	1790	1280	780

TA 7000

MISSED APPROACH

Climb straight ahead to EVS and track R-347 outbound. Passing 5000 ft turn left inbound EVS, climbing to FL 90. Passing EVS proceed outbound on R-187 and enter holding at IAF.

CATEGORY	HPMA
● S-TAC 35	740 - 2.3 659 (700 - 2.3/3.0)
● CIRCLING	1990 - 5.0 1905 (2000 - 5.0)

HPMA TACAN RWY 35

68°29.33N
016°40.70E

EVENES (ENEV)

CHANGES: FREQUENCIES, VISIBILITY MINIMA.

RNGAF 30 OCT 2025

**MIPS
INSTRUMENT APPROACH CHART**

AD ELEV 85

**HPMA TACAN A
EVENES (ENEV)**

ATIS 126.030	EVENES APPROACH 120.105 369.325		EVENES TOWER 118.005 120.105 308.775 257.800			
TACAN EVS CH 67X	APP COURSE 004°	FAF ALT 4300	MDA 1990			

CAUTION:

● CIRCLING NOT AUTHORIZED EAST OF RWY 35 / 17.

b) DO NOT USE PAPI RWY 35 OUTSIDE 5 NM.



MSA EVS 25 NM

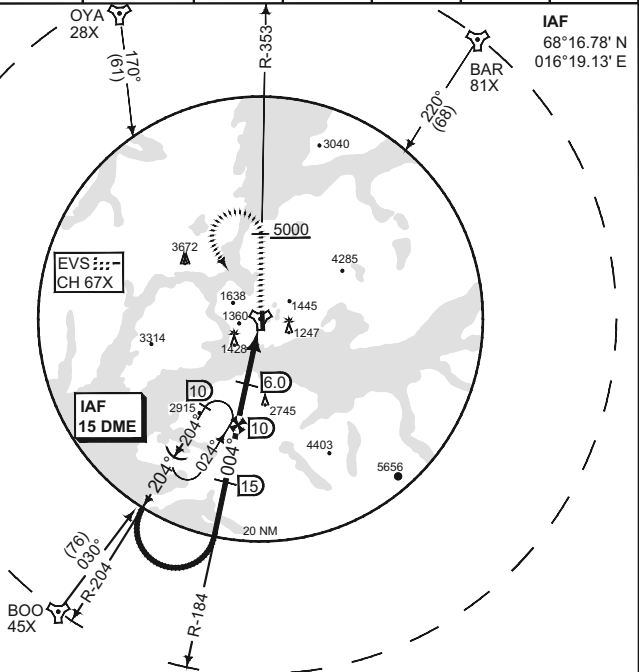
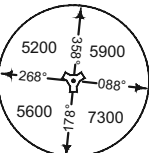

SAFE ALT 100NM 9000

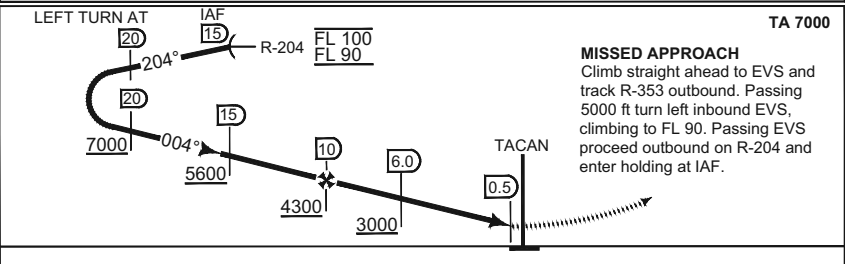

CATEGORY	HPMA
● CIRCLING	1990 - 5.0 1905 (2000 - 5.0)

CHANGES: FREQUENCIES, VISIBILITY, MINIMA

HPMA TACAN A

68°29.33N
016°40.70E

EVENES (ENEV)

RIP/CAF 30 OCT 2025

MIPS INSTRUMENT APPROACH CHART

AD ELEV 85

**TACAN A
EVENES (ENEV)**

ATIS 126.030	EVENES APPROACH 120.105 369.325		EVENES TOWER 118.005 120.105 308.775 257.800			
TACAN EVS CH 67X	APP COURSE 004°	FAF ALT 4300	MDA SEE CAT			

CAUTION:
● CIRCLING NOT AUTHORIZED EAST OF RWY 35 / 17.
b) DO NOT USE PAPI RWY 35 OUTSIDE 5 NM.



MSA EVS 25 NM

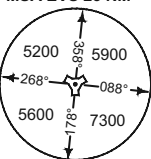

SAFE ALT 100NM 9000

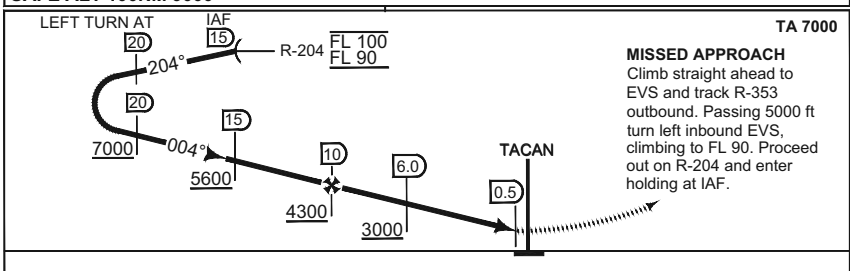

CATEGORY	A	B	C	D
● CIRCLING	1130 - 4.9 1045 (1100 - 4.9)	1690 - 5.0 1605 (1700 - 5.0)	2090 - 5.0 2005 (2100 - 5.0)	2140 - 5.0 2055 (2100 - 5.0)

TACAN A

68°29.33N
016°40.70E

EVENES (ENEV)

CHANGES: FREQUENCIES MIPS

RNO/AF 30 OCT 2025

AERODROME CHART

FLORENNES (EBFS)

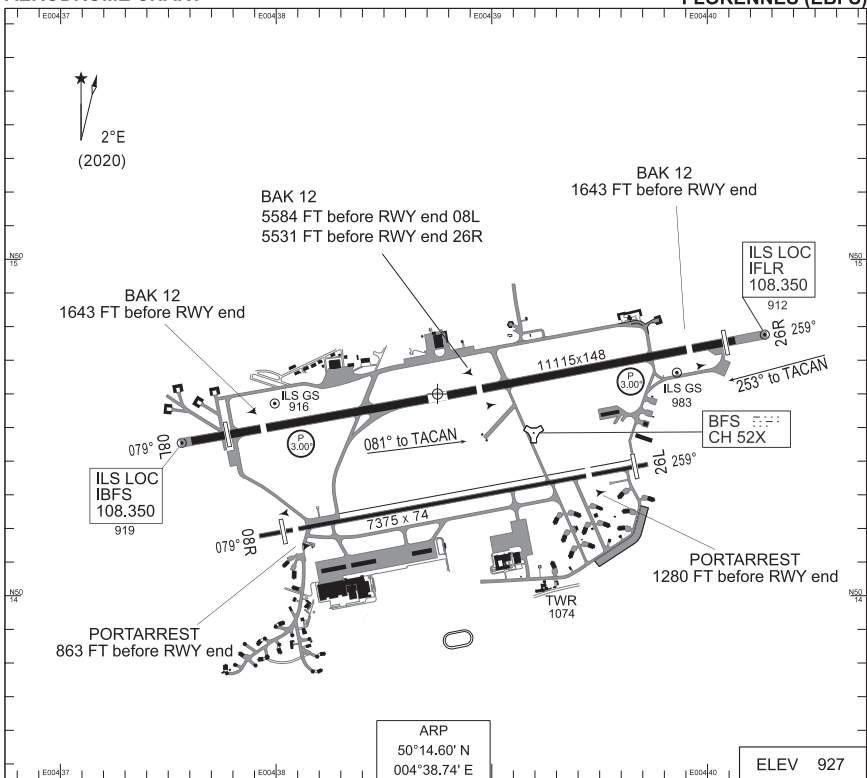

RWY	PCN	TORA	ASDA	TODA	LDA	PAPI	THR	TDZE	THR PSN
08L	71 F/A/X/T	9160	9160	10131	9160	3.00°	900	906	50°14.48' N - 004°37.77' E
26R	71 F/A/X/T	9160	9160	10144	9160	3.00°	924	927	50°14.75' N - 004°40.08' E
08R	67 F/A/X/T	6404	6404	6886	6404	-	901	911	50°14.19' N - 004°38.04' E
26L	67 F/A/X/T	6404	6404	6896	6404	-	903	911	50°14.38' N - 004°39.65' E

FLORENNES APP	372.275	362.300	377.800	124.380	122.505	FLORENNES TWR	234.800	257.800	125.880	122.100
						FLORENNES GND	122.100	356.925		

	PROC. CRITERIA	RWY	GS	TCH	OTCH	RPI	CAT	MINIMA CRITERIA	MINIMA

CHANGE: Editorial

BEL DEFENSE / AIR COMPONENT 16-APR-2026 - THS

AERODROME CHART

FLORENNES (EBFS)

MIPS
INSTRUMENT DEPARTURE CHART

FS 08A - 26A
FLORENNES (EBFS)

AD ELEV 927

FLORENNES GND		FLORENNES TWR		FLORENNES APP			BELGA RADAR			
356.925	122.100	234.800	125.880	372.275	124.380	374.400	129.325			
TACAN		RWY	PDG	From-To	120	180	240	300	360	Reason
BFS - CH 52X		08	4.46%	2.55°	DER - 2500	550	820	1090	1360	1630
		26	4.67%	2.67°	DER - 2500	570	860	1140	1420	1710
ATC										

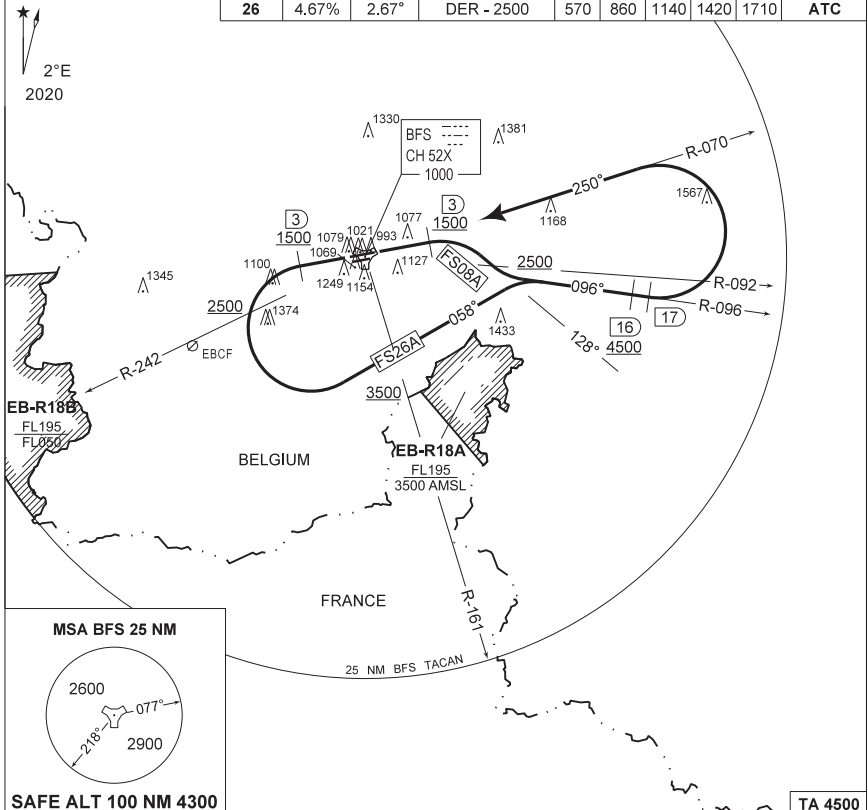

SAFE ALT 100 NM 4300

TA 4500

- | | |
|------------------------|---|
| FS 08A
(RWY 08)
 | <ul style="list-style-type: none"> - Climb straight ahead and contact EBFS APP. - At 3 DME at or above 1500 FT AMSL, turn right on track 128°. - Pass R-092 at or above 2500 FT AMSL. Intercept R-096 outbound BFS TACAN. - Pass 16 DME / R-096 at or above 4500 FT AMSL. Contact BELGA RADAR as directed. - At 17 DME turn left to intercept R-070 inbound BFS TACAN. - SID is terminated overhead BFS. |
| FS 26A
(RWY 26)
 | <ul style="list-style-type: none"> - Climb straight ahead and contact EBFS APP. - At 3 DME at or above 1500 FT AMSL, turn left on track 058°. - Pass R-242 at or above 2500 FT AMSL. - Pass R-161 at or above 3500 FT AMSL, intercept R-096 outbound BFS TACAN. - Pass 16 DME / R-096 at or above 4500 FT AMSL. Contact BELGA RADAR as directed. - At 17 DME turn left to intercept R-070 inbound BFS TACAN. - SID is terminated overhead BFS. |

CHANGE: Editorial

BEL DEFENCE. AIR COMPONENT 16-APR-2026 - THIS

FS 08A - 26A

50°14,60' N
004°38,74' E

FLORENNES (EBFS)

MIPS
INSTRUMENT DEPARTURE CHART

FS 08B - 26B
FLORENNES (EBFS)

AD ELEV 927

FLORENNES GND 356.925 122.100		FLORENNES TWR 234.800 125.880		FLORENNES APP 372.275 124.380			BELGA RADAR 374.400 129.325				
TACAN BFS - CH 52X		RWY	PDG	From-To	120	180	240	300	360	Reason	
		08	4.46%	2.55°	DER - 4500	550	820	1090	1360	1630	ATC
		26	4.67%	2.67°	DER - 2500	570	860	1140	1420	1710	ATC

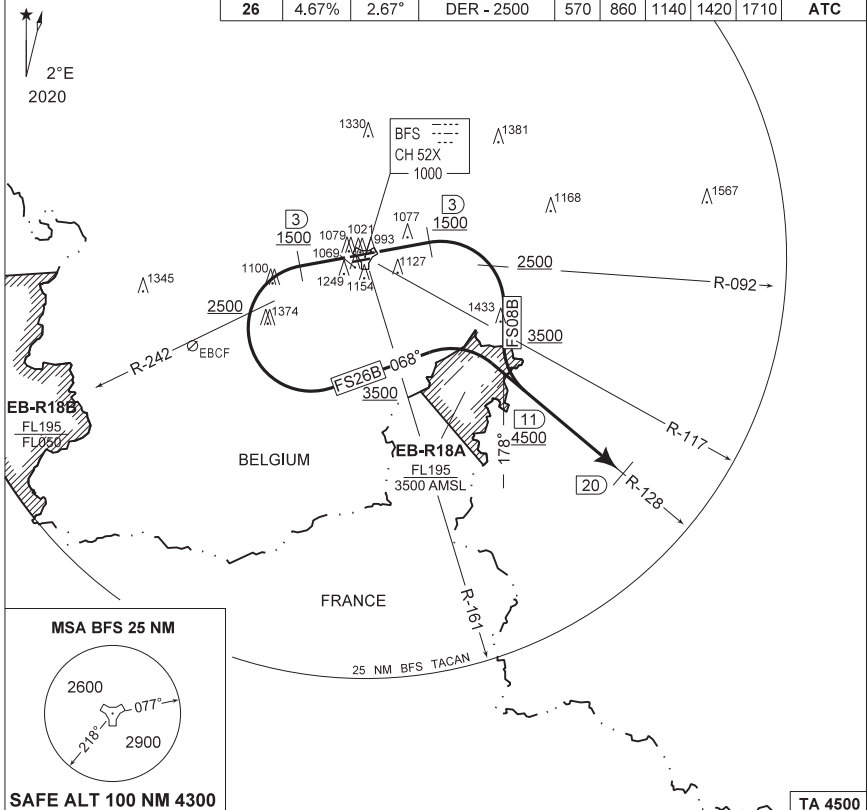

<p>FS 08B (RWY 08)</p> <p>22</p>	<ul style="list-style-type: none"> - Climb straight ahead and contact EBFS APP. - At 3 DME at or above 1500 FT AMSL, turn right on track 178°. - Pass R-092 at or above 2500 FT AMSL. - Pass R-117 at or above 3500 FT AMSL. - Intercept R-128 outbound BFS TACAN. - Pass 11 DME / R-128 at or above 4500 FT AMSL. - Contact BELGA RADAR as directed. Continue R-128 outbound till 20 DME BFS TACAN.
<p>FS 26B (RWY 26)</p> <p>31</p>	<ul style="list-style-type: none"> - Climb straight ahead and contact EBFS APP. - At 3 DME at or above 1500 FT AMSL, turn left on track 068°. - Pass R-242 at or above 2500 FT AMSL. - Pass R-161 at or above 3500 FT AMSL. - Intercept R-128 outbound BFS TACAN. - Pass 11 DME / R-128 at or above 4500 FT AMSL. - Contact BELGA RADAR as directed. Continue R-128 outbound till 20 DME BFS TACAN.

FS 08B - 26B

50°14,60' N
004°38,74' E

FLORENNES (EBFS)

CHANGE: Editorial

BEL DEFENCE, AIR COMPONENT 16-APR-2026 - THIS

MIPS
INSTRUMENT DEPARTURE CHART

FS 08C - 26C
FLORENNES (EBFS)

AD ELEV 927

FLORENNES GND		FLORENNES TWR		FLORENNES APP			BELGA RADAR				
356.925	122.100	234.800	125.880	372.275	124.380	374.400	129.325				
TACAN		RWY	PDG	From-To	120	180	240	300	360	Reason	
BFS - CH 52X		08	4.46%	2.55°	DER - 3500	550	820	1090	1360	1630	
		26	4.67%	2.67°	DER - 2500	570	860	1140	1420	1710	ATC

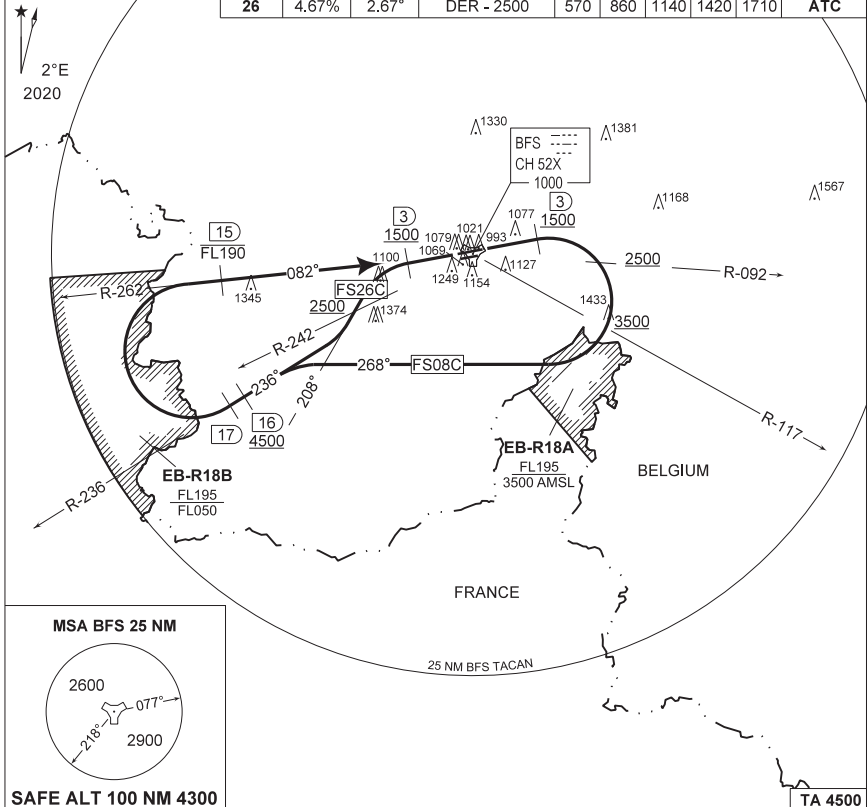

MSA BFS 25 NM

SAFE ALT 100 NM 4300

<p>FS 08C (RWY 08)</p> <p>65</p>	<ul style="list-style-type: none"> - Climb straight ahead and contact EBFS APP. - At 3 DME at or above 1500 FT AMSL, turn right on track 268°. - Pass R-092 at or above 2500 FT AMSL. - Pass R-117 at or above 3500 FT AMSL. Intercept R-236 outbound BFS TACAN. - Pass 16 DME / R-236 at or above 4500 FT AMSL. Contact BELGA RADAR as directed. - At 17 DME turn right to intercept R-262 inbound BFS TACAN. - Pass 15 DME / R-262 at or below FL190. Proceed overhead BFS.
<p>FS 26C (RWY 26)</p> <p>51</p>	<ul style="list-style-type: none"> - Climb straight ahead and contact EBFS APP. - At 3 DME at or above 1500 FT AMSL, turn left on track 208°. - Pass R-242 at or above 2500 FT AMSL. - Intercept R-236 outbound BFS TACAN. - Pass 16 DME / R-236 at or above 4500 FT AMSL. Contact BELGA RADAR as directed. - At 17 DME turn right to intercept R-262 inbound BFS TACAN. - Pass 15 DME / R-262 at or below FL190. Proceed overhead BFS.

FS 08C - 26C

50°14,60' N
004°38,74' E

FLORENNES (EBFS)

CHANGE: Editorial

BEL DEFENCE. AIR COMPONENT 16-APR-2026 - THS

MIPS
INSTRUMENT DEPARTURE CHART

AD ELEV 927

HPMA FS 08D - 08E
FLORENNES (EBFS)

FLORENNES GND 356.925 122.100	FLORENNES TWR 234.800 125.880		FLORENNES APP 372.275 124.380			BELGA RADAR 374.400 129.325				
TACAN BFS - CH 52X	RWY 08	PDG 8.75%	5.00°	From-To DER - 15.3/R-201	120 1070	180 1600	240 2130	300 2660	360 3190	Reason ATC
TACAN BBE - CH 107X										
NOTE: a) MAX 300 KT IAS.										

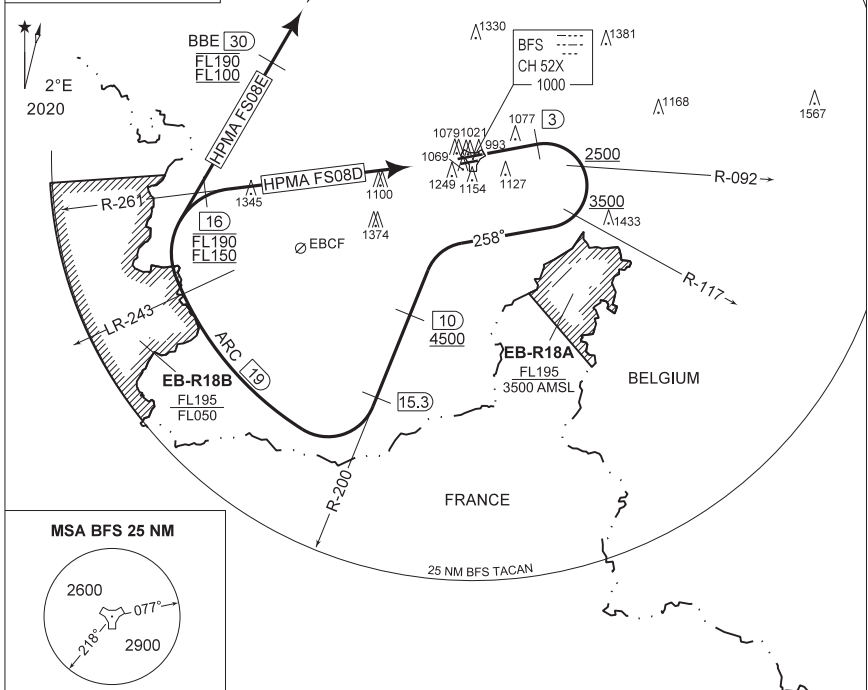

MSA BFS 25 NM

SAFE ALT 100 NM 4300

HPMA FS 08D (RWY 08) 62	<ul style="list-style-type: none"> - Climb straight ahead and contact EBFS APP. - At 3 DME turn right on track 258° to intercept R-200 outbound. - Pass R-092 at or above 2500 FT AMSL and R-117 at or above 3500 FT AMSL. - Pass 10 DME / R-200 at 4500 FT AMSL or above. - Contact BELGA RADAR passing 4500 FT AMSL. - Turn right on the 19 DME arc to intercept R-261 inbound. - Pass 16 DME / R-261 between FL150 and FL190. Climb as directed.
HPMA FS 08E (RWY 08) 58	<ul style="list-style-type: none"> - Climb straight ahead and contact EBFS APP. - At 3 DME turn right on track 258° to intercept R-200 outbound. - Pass R-092 at or above 2500 FT AMSL and R-117 at or above 3500 FT AMSL. - Pass 10 DME / R-200 at 4500 FT AMSL or above. - Contact BELGA RADAR passing 4500 FT AMSL. - Turn right on the 19 DME arc to intercept BBE R-212 inbound. - Pass BBE 30 DME / R-212 between FL100 and FL190. Climb as directed.

HPMA FS 08D - 08E

50°14,60' N
004°38,74' E

FLORENNES (EBFS)

CHANGE: Editorial

BEL DEFENCE. AIR COMPONENT 16-APR-2026 - THIS

MIPS
INSTRUMENT DEPARTURE CHART

AD ELEV 927

HPMA FS 26D - 26E
FLORENNES (EBFS)

FLORENNES GND 356.925 122.100	FLORENNES TWR 234.800 125.880		FLORENNES APP 372.275 124.380			BELGA RADAR 374.400 129.325				
TACAN BFS - CH 52X	RWY 26	PDG 8.75%	5.00°	From-To DER - 15.3/R-201	120 1070	180 1600	240 2130	300 2660	360 3190	Reason ATC
TACAN BBE - CH 107X										
NOTE: a) MAX 300 KT IAS.										

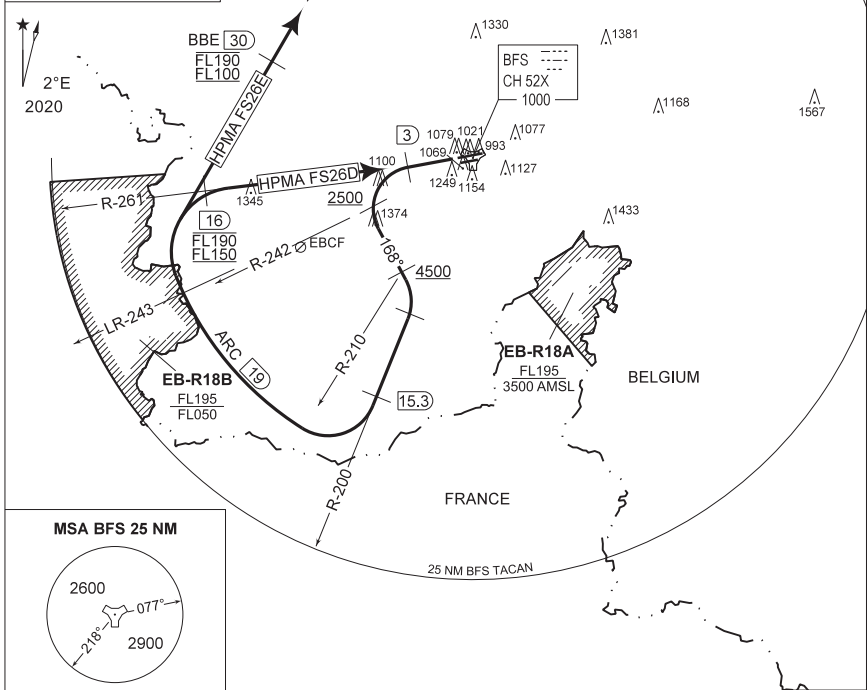

SAFE ALT 100 NM 4300

TA 4500

HPMA FS 26D (RWY 26) 51	<ul style="list-style-type: none"> - Climb straight ahead and contact EBFS APP. - At 3 DME turn left on track 168° to intercept R-200 outbound. - Pass R-242 at 2500 FT AMSL or above. - Pass R-210 at 4500 FT AMSL or above. - Contact BELGA RADAR passing 4500 FT AMSL. - Turn right on the 19 DME arc to intercept R-261 inbound. - Pass 16 DME / R-261 between FL150 and FL190. Climb as directed.
HPMA FS 26E (RWY 26) 49	<ul style="list-style-type: none"> - Climb straight ahead and contact EBFS APP. - At 3 DME turn left on track 168° to intercept R-200 outbound. - Pass R-242 at 2500 FT AMSL or above. - Pass R-210 at 4500 FT AMSL or above. - Contact BELGA RADAR passing 4500 FT AMSL. - Turn right on the 19 DME arc to intercept BBE R-212 inbound. - Pass BBE 30 DME / R-212 between FL100 and FL190. Climb as directed.

HPMA FS 26D - 26E

50°14,60' N
004°38,74' E

FLORENNES (EBFS)

CHANGE: Editorial

BEL DEFENCE. AIR COMPONENT 16-APR-2026 - THS

MIPS
INSTRUMENT APPROACH CHART

HPMA-TACAN RWY 08L
FLORENNES (EBFS)

AD ELEV 927

BELGA RADAR		FLORENNES APP		FLORENNES TWR		FLORENNES GND	
374.400	129.325	372.275	124.380	234.800	125.880	356.925	122.100
TACAN	APP COURSE	FAF ALT	DESCENT GR	MDA	THR	ALS	LDA
BFS CH 52X	081°	2500 FT	5.24%(3.00°)	1400	900 FT	750 M	9160 FT

CAUTION:

a) LOCALIZER ANTENNA 1000 FT IN FRONT OF THR RWY 08L, 10 FT ABOVE THR ELEV.

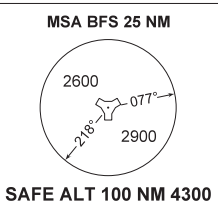
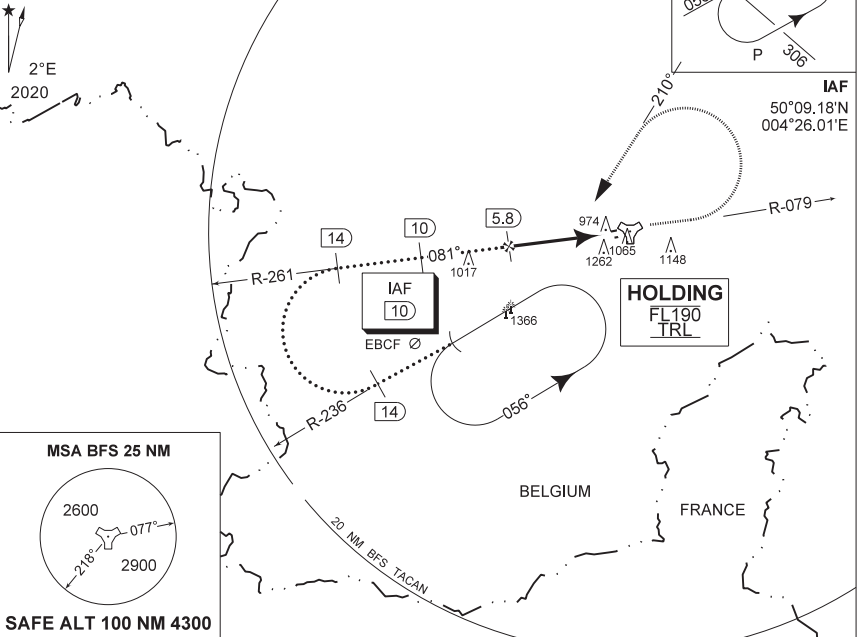

DME BFS	5	4	3
Altitude	2260	1950	1630
Height	(1360)	(1050)	(730)

MISSED APPROACH
Climb to 2000 FT on R-079. Passed 2.5 DME TACAN, continue the climb to 3000 FT and turn left on track 210° at MAX 300 KIAS to intercept IAF TACAN RWY 08L.

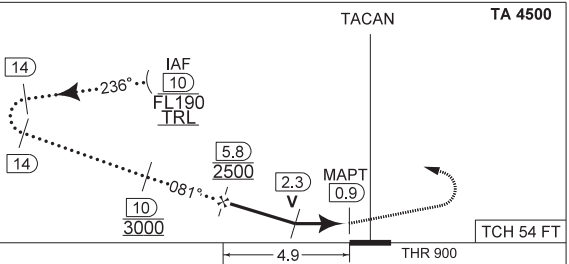

CAT I

HPMA	TCH 54 FT	THR 900
HPMA	4.9	
HPMA		
S-TAC 08L	1400 - 1.9 500 (500 - 1.9 / 2.6)	
CIRCLING	1560 - 3.2 633 (700 - 3.2)	

CHANGE: Editorial
MIPS

HPMA-TACAN RWY 08L

N50 14 36
E004 38 45

FLORENNES (EBFS)

BEL DEFENCE. AIR COMPONENT 16-APR-2026 - THS

MIPS INSTRUMENT APPROACH CHART

AD ELEV 927

TACAN RWY 08L FLORENNES (EBFS)

BELGA RADAR 374.400 129.325		FLORENNES APP 372.275 124.380		FLORENNES TWR 234.800 125.880		FLORENNES GND 356.925 122.100	
TACAN BFS CH 52X	APP COURSE 081°	FAF ALT 2500 FT	DESCENT GR 5.24%(3.00°)	MDA 1400	THR 900 FT	ALS 750 M	LDA 9160 FT

CAUTION:

a) LOCALIZER ANTENNA 1000 FT IN FRONT OF THR RWY 08L, 10 FT ABOVE THR ELEV.

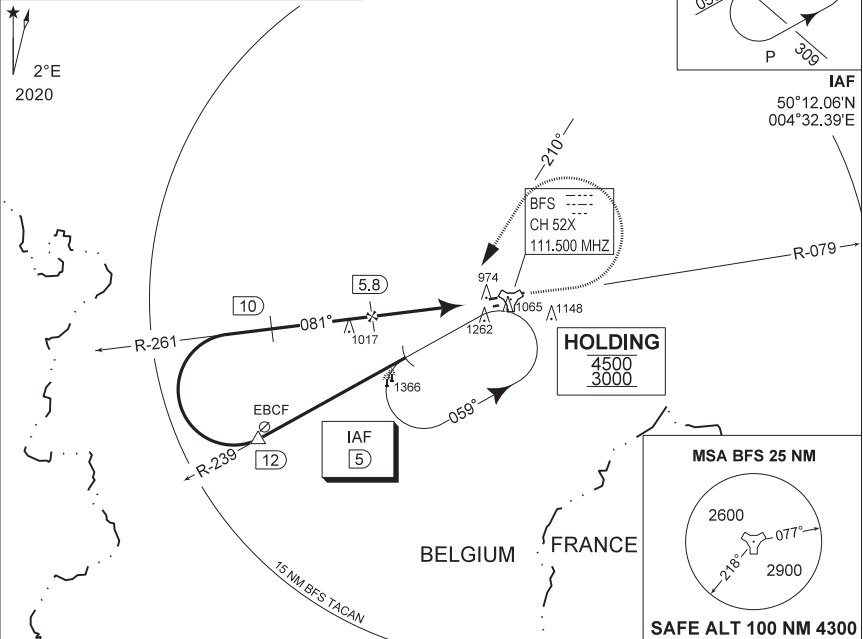
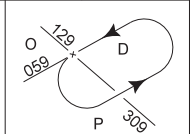

DME BFS	5	4	3
Altitude	2260	1950	1630
Height	(1360)	(1050)	(730)

MISSED APPROACH
Climb to 2000 FT on R-079. Passed 2.5 DME TACAN, continue the climb to 3000 FT and turn left on track 210° at MAX 210 KIAS (MAX 300 KIAS for HPMA) to intercept IAF TACAN RWY 08L.

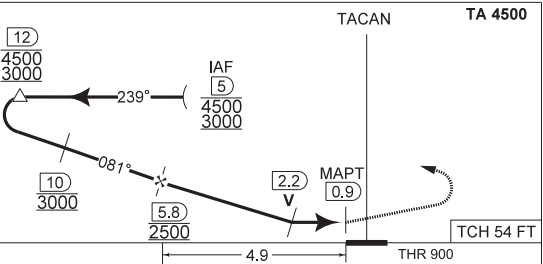

CATI

CATEGORY	A	B	C	D	HPMA
S-TAC 08L	1400 - 1.5 500 (500 - 1.5 / 2.6)		1400 - 1.9 500 (500 - 1.9 / 2.6)		
CIRCLING	1560 - 1.6 633 (700 - 1.6)		1660 - 3.6 733 (800 - 3.6)		1560 - 3.2 633 (700 - 3.2)

TACAN RWY 08L

50°14.60' N
004°38,74' E

FLORENNES (EBFS)

CHANGE: Editorial

BEL DEFENCE. AIR COMPONENT 16-APR-2026 - THIS

MIPS
INSTRUMENT APPROACH CHART

HPMA-ILS or HPMA-LOC RWY 08L
FLORENNES (EBFS)

AD ELEV 927

BELGA RADAR 374.400 129.325		FLORENNES APP 372.275 124.380		FLORENNES TWR 234.800 125.880		FLORENNES GND 356.925 122.100	
LOC/DME IFLR 108.350 / 52X	APP COURSE 077°	GS INTCP ALT 3000 FT	GS 3.00°	DA 1100	THR 900 FT	ALS 750 M	LDA 9160 FT

CAUTION:

a) LOCALIZER ANTENNA 1000 FT IN FRONT OF THR RWY 08L, 10 FT ABOVE THR ELEV.

NOTE:

a) DME INFORMATION AVAILABLE UNDER FREQUENCY 111.500 MHZ

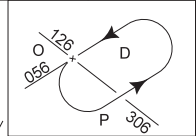

DME REQUIRED

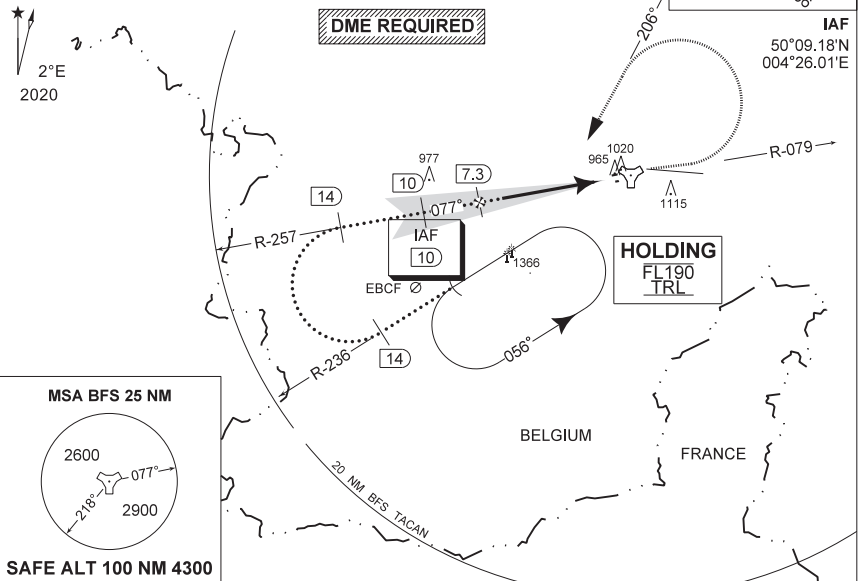

MSA BFS 25 NM

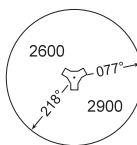

SAFE ALT 100 NM 4300

DME BFS	7	6	5	4	3	2
Altitude	2900	2580	2260	1940	1620	1310
Height	(2000)	(1680)	(1360)	(1040)	(720)	(410)

MISSED APPROACH

Climb to 2000 FT on R-079. Passed 2.5 DME TACAN, continue the climb to 3000 FT and turn left on track 206° MAX 300 KIAS to intercept IAF ILS RWY 08L.

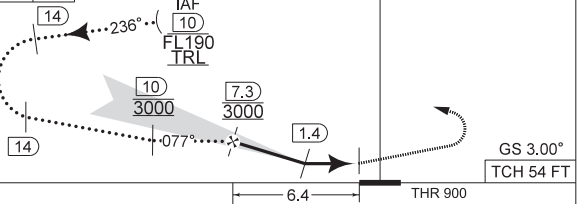

CATI

HPMA 6.4 THR 900 TCH 54 FT GS 3.00°

CATEGORY	HPMA
S-ILS 08L	1100 - 0.8 200 (200 - 0.8 / 0.9) GS 3.00°
S-LOC	1360 - 1.7 460 (500 - 1.7 / 2.4)
CIRCLING	1560 - 3.2 633 (700 - 3.2)

CHANGE: Editorial MIPS

HPMA-ILS or HPMA-LOC RWY 08L

N50 14 36
E004 38 45

FLORENNES (EBFS)

BEL DEFENCE, AIR COMPONENT 16-APR-2028 - THS

MIPS
INSTRUMENT APPROACH CHART

AD ELEV 927

ILS or LOC RWY 08L
FLORENNES (EBFS)

BELGA RADAR 374.400 129.325		FLORENNES APP 372.275 124.380		FLORENNES TWR 234.800 125.880		FLORENNES GND 356.925 122.100	
LOC/DME IFLR 108.350 / 52X	APP COURSE 077°	GS INTCP ALT 3000 FT	GS 3.00°	DA 1100	THR 900 FT	ALS 750 M	LDA 9160 FT

CAUTION:

a) LOCALIZER ANTENNA 1000 FT IN FRONT OF THR RWY 08L, 10 FT ABOVE THR ELEV.

NOTE:

a) DME INFORMATION AVAILABLE UNDER FREQUENCY 111.500 MHZ

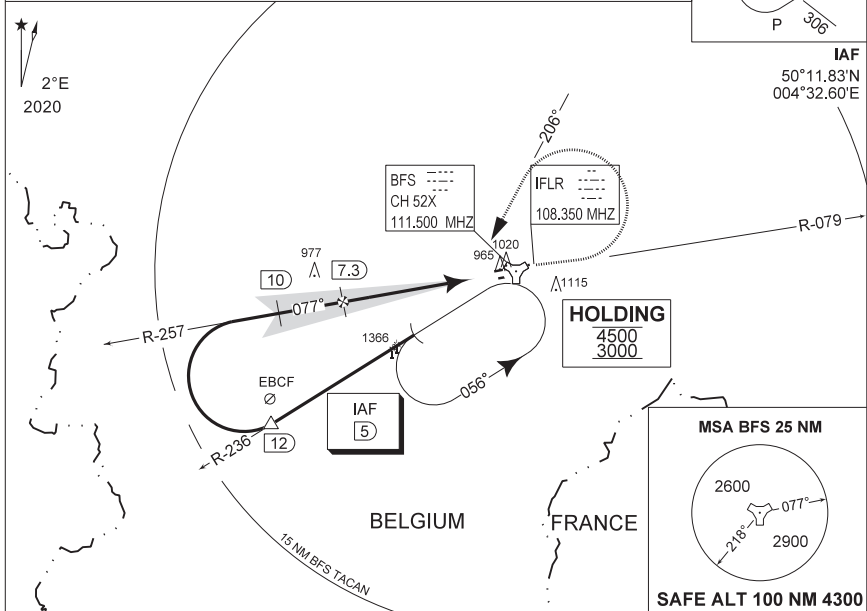
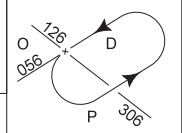

DME BFS	7	6	5	4	3	2	TACAN	TA 4500
Altitude	2900	2580	2260	1940	1620	1310		
Height	(2000)	(1680)	(1360)	(1040)	(720)	(410)		

MISSED APPROACH

Climb to 2000 FT on R-079. Passed 2.5 DME TACAN, continue the climb to 3000 FT and turn left on track 206° at MAX 210 KIAS (MAX 300 KIAS for HPMa) to intercept IAF ILS RWY 08L.

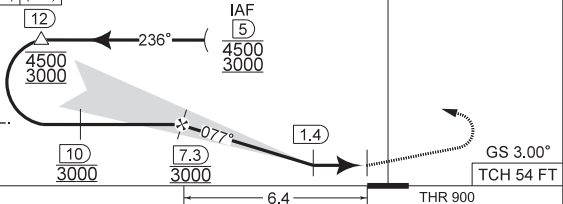

CATI

CATEGORY	A	B	C	D	HPMA
S-ILS 08L	1100 - 0.8 200 (200 - 0.8 / 0.9) GS 3.00°				
S-LOC 08L	1360 - 1.5 460 (500 - 1.5 / 2.4)	1360 - 1.7 460 (500 - 1.7 / 2.4)			
CIRCLING	1560 - 1.6 633 (700 - 1.6)	1660 - 3.6 733 (800 - 3.6)	1560 - 3.2 633 (700 - 3.2)		

ILS or LOC RWY 08L

50°14,60' N
004°38,74' E

FLORENNES (EBFS)

CHANGE: Editorial

BEL DEFENCE, AIR COMPONENT 16-APR-2028 - THS

MIPS
INSTRUMENT APPROACH CHART

HPMA-ILS or HPMA-LOC RWY 26R
FLORENNES (EBFS)

AD ELEV 927

BELGA RADAR 374.400 129.325		FLORENNES APP 372.275 124.380		FLORENNES TWR 234.800 125.880		FLORENNES GND 356.925 122.100		
LOC / DME IBFS 108.350 / 52X		APP COURSE 257°	GS INTCP ALT 3000 FT	GS 3.00°	DA 1124	THR 924 FT	ALS 900 M	LDA 9160 FT

NOTE:

a) DME INFORMATION AVAILABLE UNDER FREQUENCY 111.500 MHZ

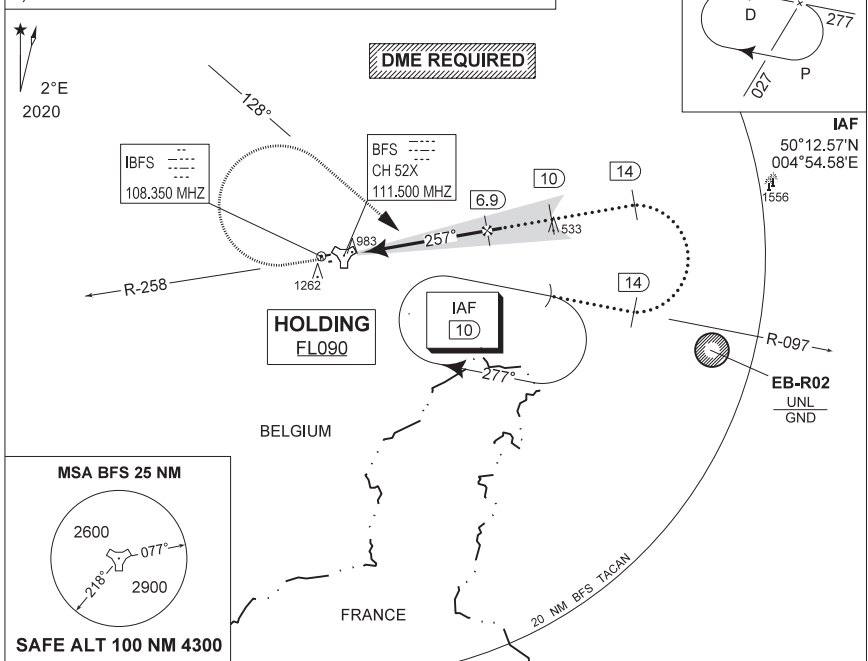

DME BFS	6	5	4	3	2	TACAN	TA 4500
Altitude	2690	2380	2060	1790	1420		
Height	(1766)	(1456)	(1136)	(816)	(496)		

MISSED APPROACH

Climb to 2000 FT on R-258. Passed 2.5 DME TACAN, continue the climb to 3000 FT and turn right on track 128° at MAX 300 KIAS to intercept IAF ILS RWY 26R.

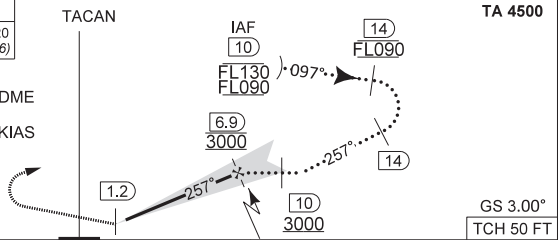

CAT I	THR 924	6.3	GS 3.00°	TCH 50 FT
-------	---------	-----	----------	-----------

CATEGORY	HPMA
S-ILS 26R	1124 - 0.8 200 (200 - 0.8 / 1.0) GS 3.00°
S-LOC 26R	1320 - 1.3 396 (400 - 1.3 / 2.2)
CIRCLING	1560 - 3.2 633 (700 - 3.2)

HPMA-ILS or HPMA-LOC RWY 26R

50°14.60' N
004°38.74' E

FLORENNES (EBFS)

CHANGE: Editorial

BEL DEFENSE. AIR COMPONENT 16-APR-2026 - THS

MIPS
INSTRUMENT APPROACH CHART

AD ELEV 927

ILS or LOC RWY 26R
FLORENNES (EBFS)

BELGA RADAR 374.400 129.325		FLORENNES APP 372.275 124.380		FLORENNES TWR 234.800 125.880		FLORENNES GND 356.925 122.100		
LOC / DME IBFS 108.350 / 52X		APP COURSE 257°	GS INTCP ALT 3000 FT	GS 3.00°	DA 1124	THR 924 FT	ALS 900 M	LDA 9160 FT

NOTE:

a) DME INFORMATION AVAILABLE UNDER FREQUENCY 111.500 MHZ

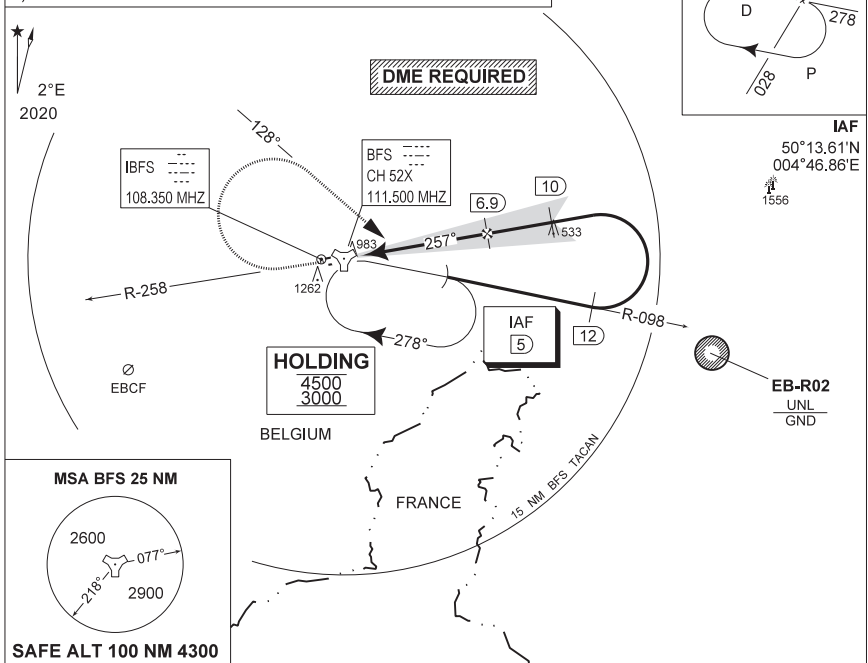

IAF

50°13.61'N
004°46.86'E

1556

EB-R02
UNL
GND

MSA BFS 25 NM

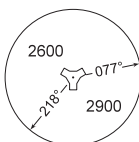

SAFE ALT 100 NM 4300

DME BFS	6	5	4	3	2
Altitude	2690	2380	2060	1790	1420
Height	(1766)	(1456)	(1136)	(816)	(496)

TACAN

TA 4500

MISSED APPROACH

Climb to 2000 FT on R-258. Passed 2.5 DME TACAN, continue the climb to 3000 FT and turn right on track 128° at MAX 210 KIAS (MAX 300 KIAS for HPMA) to intercept IAF TACAN RWY 26R or ILS RWY 26R.

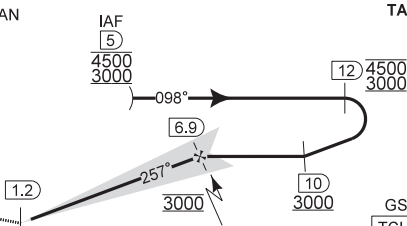

GS 3.00°
TCH 50 FT

CAT I	<input checked="" type="checkbox"/>	THR 924	6.3	
-------	-------------------------------------	---------	-----	--

CATEGORY	A	B	C	D	HPMA
S-ILS 26R	1124 - 0.8 200 (200 - 0.8 / 1.0) GS 3.00°				
S-LOC 26R	1320 - 1.3 396 (400 - 1.3 / 2.2)				
CIRCLING	1560 - 1.6 633 (700 - 1.6)		1660 - 3.6 733 (800 - 3.6)		1560 - 3.2 633 (700 - 3.2)

ILS or LOC RWY 26R

50°14.60' N
004°38.74' E

FLORENNES (EBFS)

CHANGE: Editorial

BELDEFENCE. AIR COMPONENT 16-APR-2026 - THS

MIPS INSTRUMENT APPROACH CHART

AD ELEV 927

HPMA-TACAN RWY 26R FLORENNES (EBFS)

BELGA RADAR 374.400 129.325		FLORENNES APP 372.275 124.380		FLORENNES TWR 234.800 125.880		FLORENNES GND 356.925 122.100	
TACAN BFS CH 52X	APP COURSE 253°	FAF ALT 2500 FT	DESCENT GR 5.24%(3.00°)	MDA 1320	THR 924 FT	ALS 900 M	LDA 9160 FT

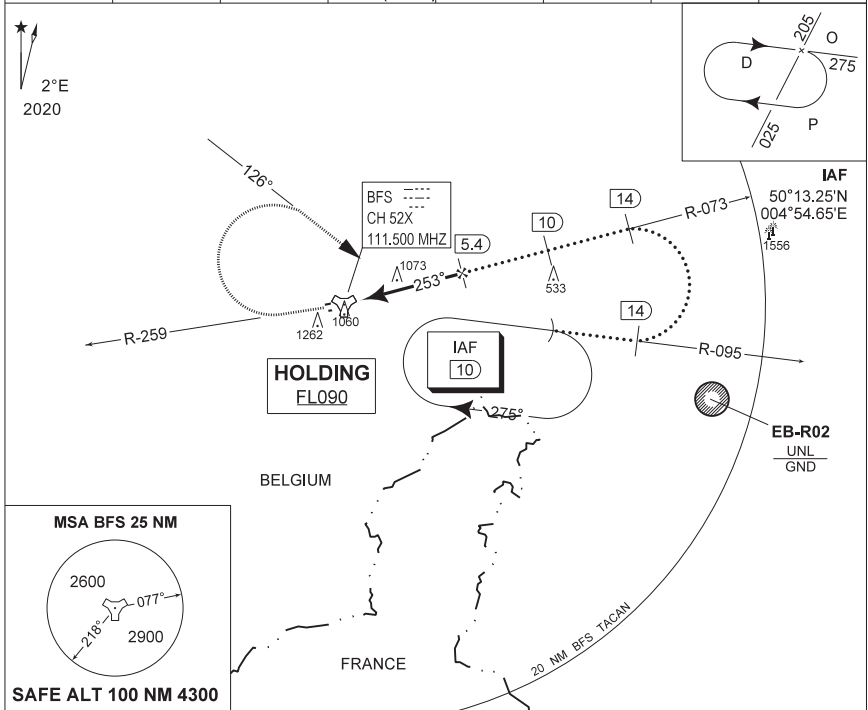

DME BFS	5	4	3	2
Altitude	2370	2050	1730	1460
Height	(1446)	(1126)	(806)	(486)

MISSSED APPROACH
Climb to 2000 FT on R-259. Passed 2.5 DME TACAN, continue the climb to 3000 FT and turn right on track 126° at MAX 300 KIAS to intercept IAF TACAN RWY 26R.

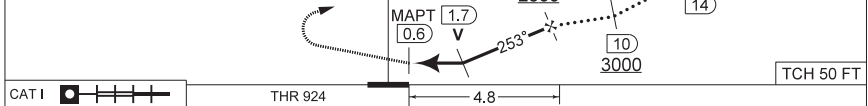

CAT I	THR 924	4.8	TCH 50 FT
CATEGORY	HPMA		
S-TAC 26R	1320 - 1.3 396 (400 - 1.3 / 2.2)		
CIRCLING	1560 - 3.2 633 (700 - 3.2)		

HPMA-TACAN RWY 26R

50°14.60' N
004°38.74' E

FLORENNES (EBFS)

CHANGE: Editorial

BELDEFENCE. AIP COMPONENT 16-APR-2026 - THIS

MIPS INSTRUMENT APPROACH CHART

AD ELEV 927

TACAN RWY 26R FLORENNES (EBFS)

BELGA RADAR 374.400 129.325		FLORENNES APP 372.275 124.380		FLORENNES TWR 234.800 125.880		FLORENNES GND 356.925 122.100	
TACAN BFS CH 52X	APP COURSE 253°	FAF ALT 2500 FT	DESCENT GR 5.24% (3.00°)	MDA 1320	THR 924 FT	ALS 900 M	LDA 9160 FT

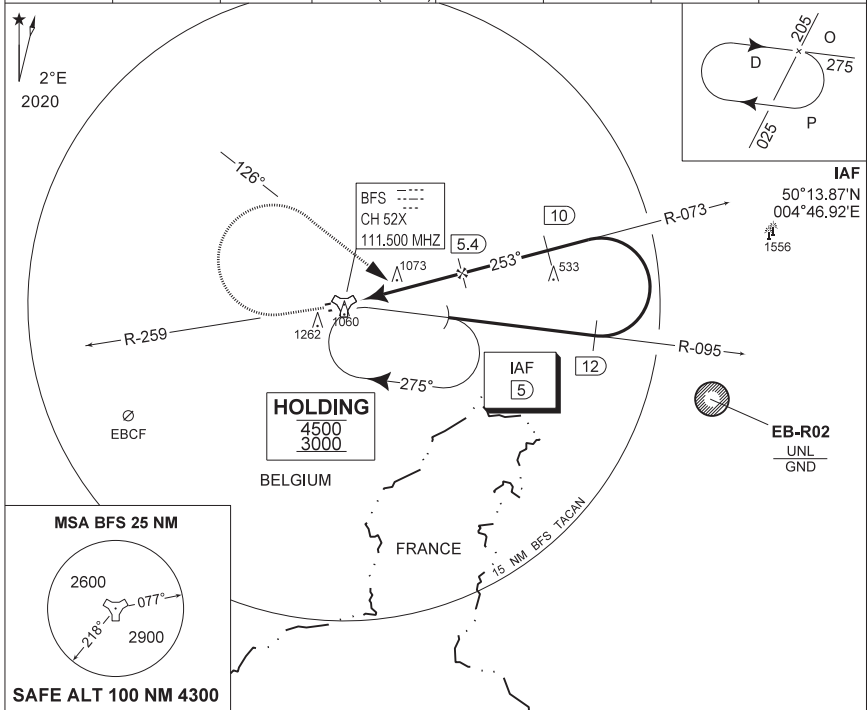

DME BFS	5	4	3	2	TACAN	REMAIN WITHIN 16 DME	TA 4500
Altitude	2370	2050	1730	1460			
Height	(1446)	(1126)	(806)	(486)			

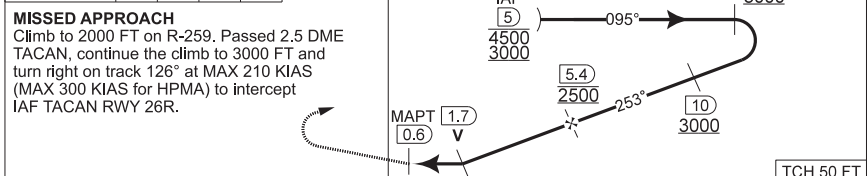

CAT I	THR 924	4.8	
-------	---------	-----	--

CATEGORY	A	B	C	D	HPMA
S-TAC 26R	1320 - 1.3 396 (400 - 1.3 / 2.2)				
CIRCLING	1560 - 1.6 633 (700 - 1.6)		1660 - 3.6 733 (800 - 3.6)		1560 - 3.2 633 (700 - 3.2)

TACAN RWY 26R 50°14.60' N **FLORENNES (EBFS)**
004°38.74' E

CHANGE: Editorial

BELDEFENCE. AIR COMPONENT 16-APR-2026 - THIS

AERODROME CHART

GARDERMOEN (ENGM)

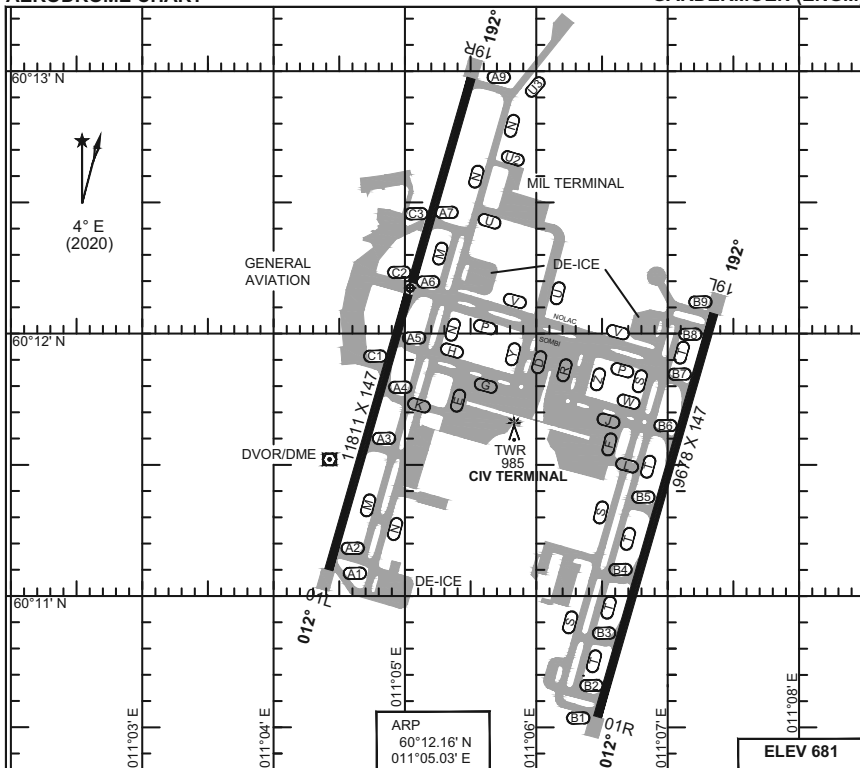

RWY	PCN	TORA	ASDA	TODA	LDA	PAPI	ALS	TDZE	THR PSN
01L	75 F/A/W/T	11811	11811	11811	11811	3.0°	BP	656	60°11.10' N - 011°04.42' E
19R	75 F/A/W/T	11811	11811	11811	11811	3.0°	BN	675	60°12.60' N - 011°05.50' E
01R	75 F/A/W/T	9678	9678	9678	9678	3.0°	BN	670	60°10.55' N - 011°06.47' E
19L	75 F/A/W/T	9678	9678	10990	9678	3.0°	BP	681	60°12.07' N - 011°07.35' E

ATIS - DEP 127.155
 ATIS - ARR 126.130
 GARDERMOEN DELIVERY DLV WEST 121.680
 DLV EAST 121.930
 GARDERMOEN GROUND GND WEST 121.605
 GND EAST 121.905
 DE-ICE COORDINATOR 121.855
 GARDERMOEN TOWER SECTOR WEST INCL ILS 01L/19R 118.305 257.800
 SECTOR EAST INCL ILS 01R/19L 120.105 257.800
 GARDERMOEN OPS (MIL) 123.275 362.800

CHANGES: FREQUENCIES

RNGAF-20 MAR 2025

AERODROME CHART

GARDERMOEN (ENGM)

MIPS
INSTRUMENT APPROACH CHART

AD ELEV 681

HPMA ILS or LOC RWY 01L
GARDERMOEN (ENGM)

ATIS	OSLO APP	DIRECTOR	FINAL	GARDERMOEN TWR		GROUND		
126.130	W 120.455 E 118.480	136.405	128.905	W 118.305	E 120.105	W 121.605	E 121.905	
LOCALIZER/DME		APP COURSE	GS INTCP ALT	GS	DA	THR ELEV	ALS	LDA
OBW 110.300 / CH40X		012°	3500	3.0°	856	656	670 m	11811

CAUTION:

● CIRCLING NOT AUTHORIZED
EAST OF RWY 01L / 19R.

NOTE:

- b) DME REQUIRED.
- c) RADAR VECTORS TO FINAL REQUIRED.
- d) MIN 160 KIAS UNTIL OBW 4.0 DME.

OGRAS
59°59.62' N
010°57.85' E

GRM
60°11.51' N
011°04.47' E

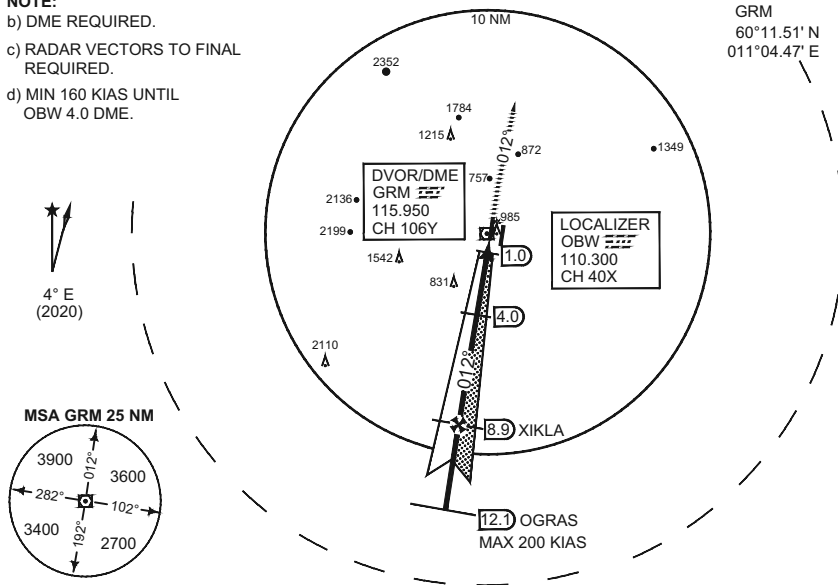

SAFE ALT 100 NM 9700

DME OBW	8	7	6	5	4	3	2
ALT	3210	2890	2570	2250	1940	1620	1300

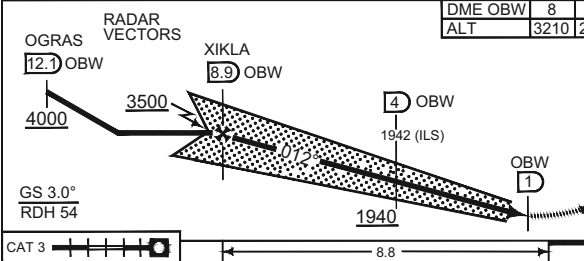

TA 7000

MISSED APPROACH

Climb on track 012° to 5000 ft. Expect vectors by Oslo App.
In case of RCF: Climb on track 012° to 5000 ft. After passing OBW 20 DME turn left DCT GRM for new approach. Remain within GRM 25 DME.

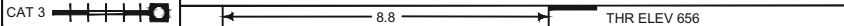

CATEGORY	HPMA
S-ILS 01L	856 -800 200 (200-0.8/1.2)
S-LOC 01L	960 -1200 304 (400-1.2/1.6)
● CIRCLING	2040 -3.2 1359 (1400-3.2)

HPMA ILS or LOC RWY 01L

60°12.16' N
011°05.03' E

GARDERMOEN (ENGM)

CHANGES: FREQUENCIES MIPS

RNOA/F 20 MAR 2025

MIPS
INSTRUMENT APPROACH CHART

AD ELEV 681

HPMA ILS or LOC RWY 01R
GARDERMOEN (ENGM)

ATIS	OSLO APP	DIRECTOR	FINAL	GARDERMOEN TWR	GROUND		
126.130	W 120.455 E 118.480	136.405	128.905	W 118.305 E 120.105	W 121.605	E 121.905	
LOCALIZER/DME	APP COURSE	GS INTCP ALT	GS	DA	THR ELEV	ALS	LDA
ONE 111.950 / CH56Y	012°	3500	3.0°	880	670	880 m	9678

CAUTION:

- CIRCLING NOT AUTHORIZED WEST OF RWY 01R / 19L.

NOTE:

- b) DME REQUIRED.
- c) RADAR VECTORS TO FINAL REQUIRED.
- d) MIN 160 KIAS UNTIL ONE 4.0 DME.

NOSLA
59°59.02' N
010°59.85' E

GRM
60°11.51' N
011°04.47' E

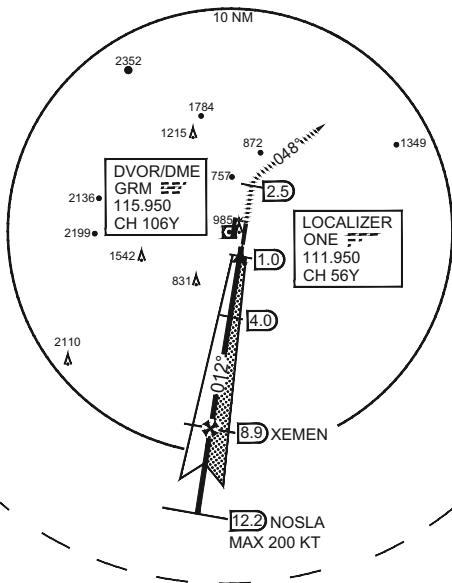

MSA GRM 25 NM

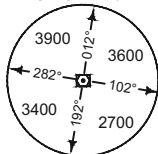

SAFE ALT 100 NM 9700

DME ONE	8	7	6	5	4	3	2
ALT	3220	2900	2590	2270	1950	1630	1310

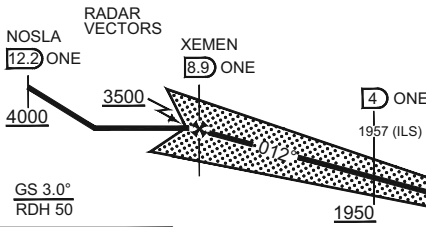

MISSED APPROACH

TA 7000

Climb on track 012° to DME 2.5 after ONE. Turn right (MAX 265 KIAS) and proceed on HDG 048° to 4000 ft. Expect vectors.

In case of RCF: Climb to 4000 ft on HDG 048°. After passing ONE 20 DME turn right DCT GRM for new approach. Remain within GRM 25 DME.

CAT 3

8.7 THR ELEV 670

CATEGORY	HPMA	
	S-ILS 01R	880
S-LOC 01R	970	-1200 300 (300-1.2/1.6)
● CIRCLING	1570	- 3.2 889 (900-3.2)

HPMA ILS or LOC RWY 01R

60°12.16' N
011°05.03' E

GARDERMOEN (ENGM)

CHANGES, FREQUENCIES
MIPS

RNOAEP 20 MAR 2025

MIPS
INSTRUMENT APPROACH CHART

AD ELEV 681

HPMA ILS or LOC RWY 19L
GARDERMOEN (ENGM)

ATIS	OSLO APP	DIRECTOR	FINAL	GARDERMOEN TWR	GROUND		
126.130	W 120.455 E 118.480	136.405	128.905	W 118.305 E 120.105	W 121.605 E 121.905		
LOCALIZER/DME	APP COURSE	GS INTCP ALT	GS	DA	THR ELEV	ALS	LDA
GME 110.550 / CH 42Y	192°	3500	3.0°	881	681	900 m	9678

CAUTION:

- CIRCLING NOT AUTHORIZED WEST OF RWY 19L / 01R.

NOTE:

- b) DME REQUIRED.
- c) RADAR VECTORS TO FINAL REQUIRED.
- d) MIN 160 KIAS UNTIL GME 4.0 DME.

OSPAD
60°24.06' N
011°14.32' E

GRM
60°11.51' N
011°04.47' E

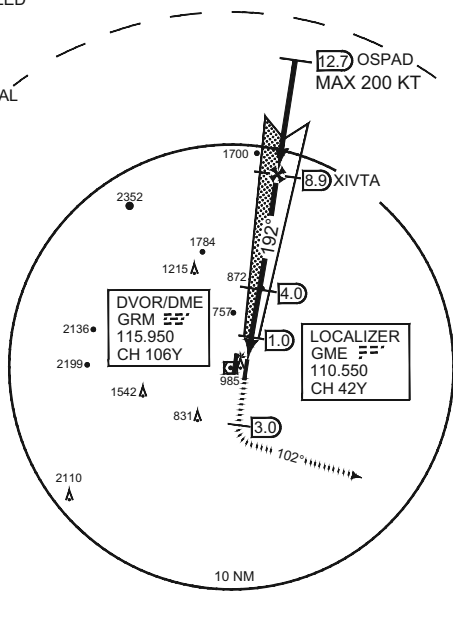

MSA GRM 25 NM

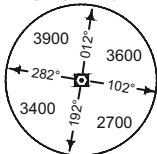

SAFE ALT 100 NM 9700

MISSED APPROACH

Climb on track 192°. At DME 3.0 after GME, turn left to track 102° (MAX 265 KIAS) climbing to 3000 ft. At DME 13.0 GME, climb to 5000 ft. Expect vectors.

In case of RCF: Continue on track 102° to 5000 ft. At DME 20 GME turn left DCT GRM for new approach. Remain within DME 25 GRM.

DME GME	2	3	4	5	6	7	8
ALT	1320	1640	1950	2270	2590	2910	3230

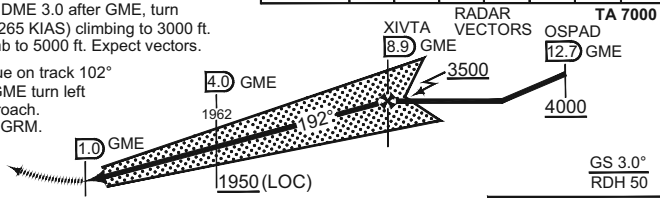

THR ELEV 681

8.7

CAT 3

MIPS	CATEGORY	HPMA
	S-ILS 19L	881 - 800 200 (200-0.8/1.2)
	S-LOC 19L	1030 - 1200 349 (400-1.2/1.6)
● CIRCLING		1570 - 3.2 889 (900-3.2)

HPMA ILS or LOC RWY 19L

60°12.16' N
011°05.03' E

GARDERMOEN (ENGM)

CHANGES: FREQUENCIES

ENGM AF 20 MAR 2025

MIPS
INSTRUMENT APPROACH CHART

HPMA ILS or LOC RWY 19R
GARDERMOEN (ENGM)

AD ELEV 681

ATIS	OSLO APP	DIRECTOR	FINAL	GARDERMOEN TWR	GROUND		
126.130	W 120.455 E 118.480	136.405	128.905	W 118.305 E 120.105	W 121.605 E 121.905		
LOCALIZER/DME	APP COURSE	GS INTCP ALT	GS	DA	THR ELEV	ALS	LDA
GSW 111.300 / CH 50X	192°	3500	3.0°	875	675	900 m	11811

CAUTION:

● CIRCLING NOT AUTHORIZED EAST OF RWY 19R / 01L.

NOTE:

- b) DME REQUIRED.
- c) RADAR VECTORS TO FINAL REQUIRED.
- d) MIN 160 KIAS UNTIL GSW 4.0 DME.

ODUDI
60°24.37' N
011°12.11' E

GRM
60°11.51' N
011°04.47' E

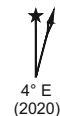

MSA GRM 25 NM

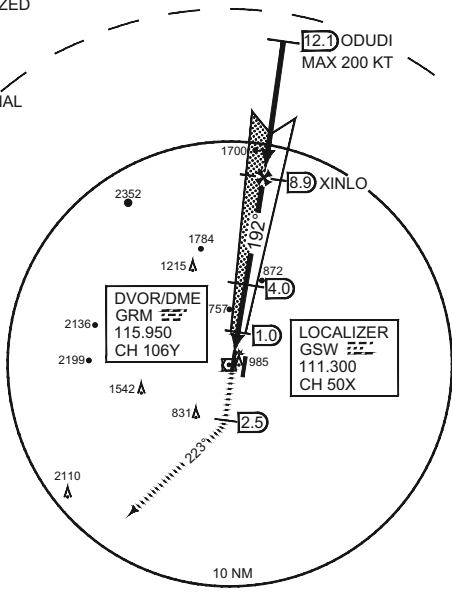
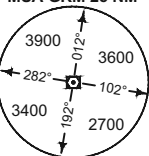

SAFE ALT 100 NM 9700

MISSED APPROACH

Climb on track 192°. At DME 2.5 after GSW, turn right to track 223° (MAX 265 KIAS) climbing to 5000 ft. Expect vectors by Oslo App.

In case of RCF: Continue on track 223°. Climb to 5000 ft. At DME 20 GSW, turn right DCT GRM for new approach. Remain within DME 25 GRM.

DME GSW	2	3	4	5	6	7	8
ALT	1320	1630	1950	2270	2590	2910	3230

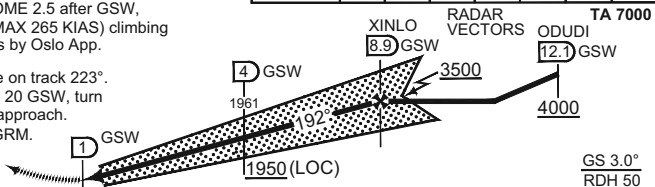

THR ELEV 675

8.7

CAT 3

CATEGORY	HPMA
S-ILS 19R	875 - 800 200 (200-0.8/1.2)
S-LOC 19R	1020 - 1200 345 (400-1.2/2.0)
● CIRCLING	1980 - 3.2 1299 (1300-3.2)

HPMA ILS or LOC RWY 19R

60°12.16' N
011°05.03' E

GARDERMOEN (ENGM)

CHANGES: FREQUENCIES, EDITORIALS

RNGAEP 20 MAR 2025

MIPS
AERODROME CHART

GILZE-RIJEN (EHGR)

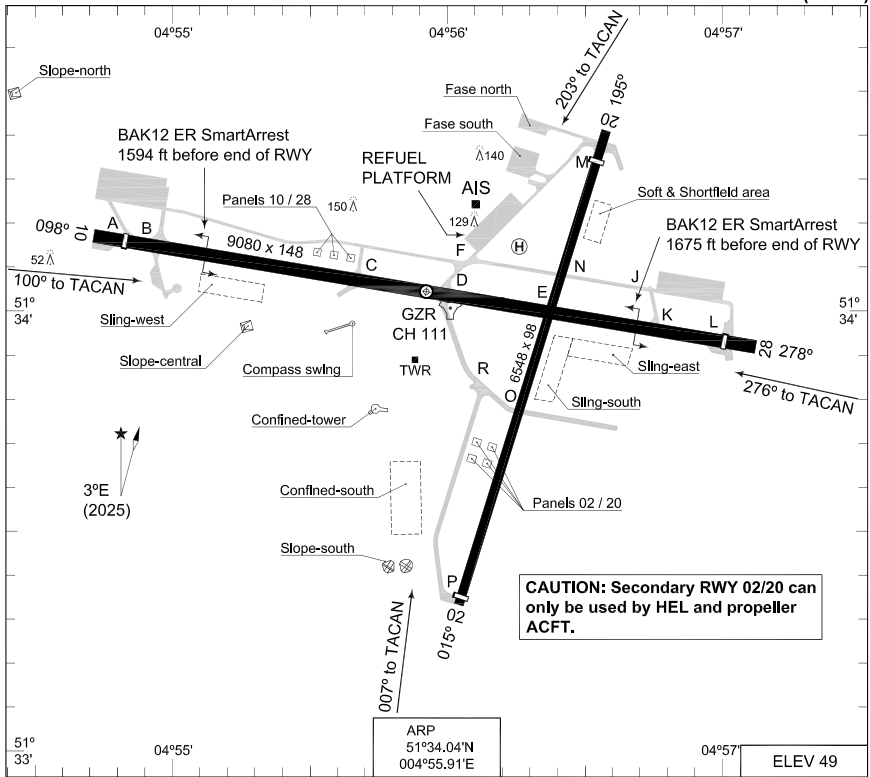

RWY	PCN	PCR	TORA	ASDA	TODA	LDA	PAPI	THR ELEV	THR PSN
28	50 R/C/W/T	527 R/C/W/T	9080	9080	9080	8806	3.0°	35	51°33.92'N 004°57.00'E
10	50 R/C/W/T	527 R/C/W/T	9080	9080	9080	8392	3.0°	41	51°34.16'N 004°54.82'E
20	45 R/C/W/T	474 R/C/W/T	6548	6548	6548	6181		36	51°34.31'N 004°56.51'E
02	45 R/C/W/T	474 R/C/W/T	6548	6548	6548	6249		48	51°33.39'N 004°56.03'E

GILZE-RIJEN TWR	277.350	125.330	(Ground Control)	278.125	123.300
GILZE-RIJEN ARRIVAL	359.975				
RAPCON WEST	399.725	123.580			

	PROC. CRITERIA	RWY	GS	TCH	OTCH	RPI	CAT	MINIMA CRITERIA	MINIMA

**TERPS
INSTRUMENT DEPARTURE CHART**

**GR1
GILZE-RIJEN (EHGR)**

GND CTL 278.125 123.300		GILZE-RIJEN TWR 277.350 125.330		AD ELEV 49				RAPCON WEST 399.725 123.580				DUTCH MIL 336.325 125.930			
				RWY	Knots	120	180	240	300	360	to				
				28V/V (fpm)		480	720	960	1200	1440	150 ft				

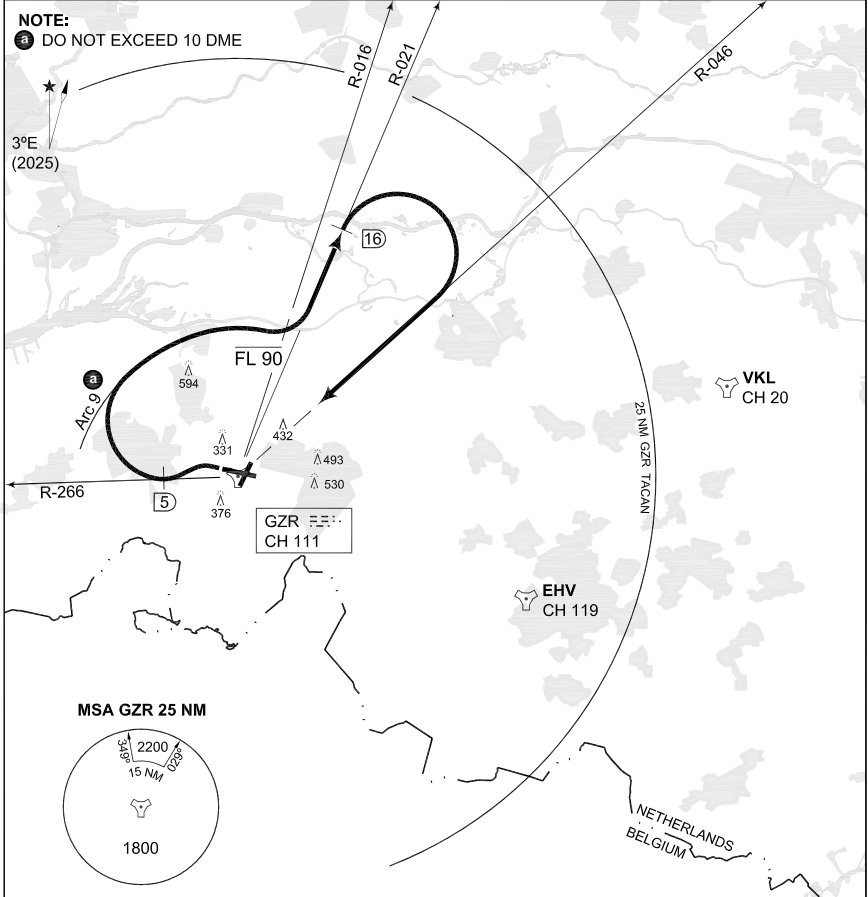

EMERG SAFE ALT 100 NM 4000

TA 3000

**GILZE-RIJEN 1
(RWY 28)**

- At 1.3 DME turn left to intercept R-266 outbound, level off at FL 90.
- At 5 DME turn right to intercept Arc 9.
- Intercept R-021 outbound, when crossing R-016 continue climb.
- At 16 DME turn right to intercept R-046 inbound.

CHANGE:EDITORIAL

RNLASF 16 APR 2026

GR1

51°34.04'N
004°55.91'E

GILZE-RIJEN (EHGR)

**TERPS
INSTRUMENT DEPARTURE CHART**

AD ELEV 49

**GR3
GILZE-RIJEN (EHGR)**

GND CTL 278.125 123.300	GILZE-RIJEN TWR 277.350 125.330	RAPCON WEST 399.725 123.580	DUTCH MIL 336.325 125.930
----------------------------	------------------------------------	--------------------------------	------------------------------

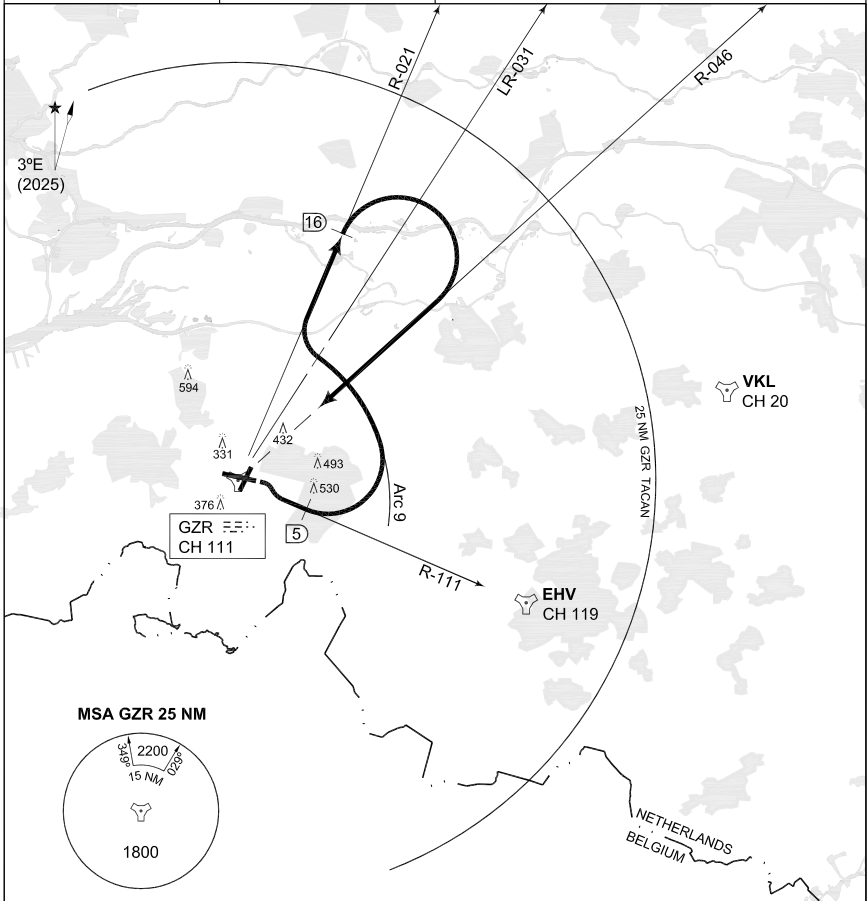

EMERG SAFE ALT 100 NM 4000

TA 3000

**GILZE-RIJEN 3
(RWY 10)**

- At 1 DME turn right to intercept R-111 outbound.
- At 5 DME turn left to intercept Arc 9.
- When crossing R-031 turn right to intercept R-021 outbound.
- At 16 DME turn right to intercept R-046 inbound.

CHANGE-EDITORIAL

RNLASF 16 APR 2026

GR3

51°34.04'N
004°55.91'E

GILZE-RIJEN (EHGR)

MIPS
INSTRUMENT APPROACH CHART

COPTER TACAN 007
GILZE-RIJEN (EHGR)

AD ELEV 49

DUTCH MIL 336.325 125.930		RAPCON WEST 399.725 123.580		GILZE-RIJEN TWR 277.350 125.330		GND CTL 278.125 123.300	
TACAN GZR CH 111	APP COURSE 007°	FAF ALT 800 FT	Descent GR	MDA 460	THR ELEV 48	ALS -	LDA 6249 FT

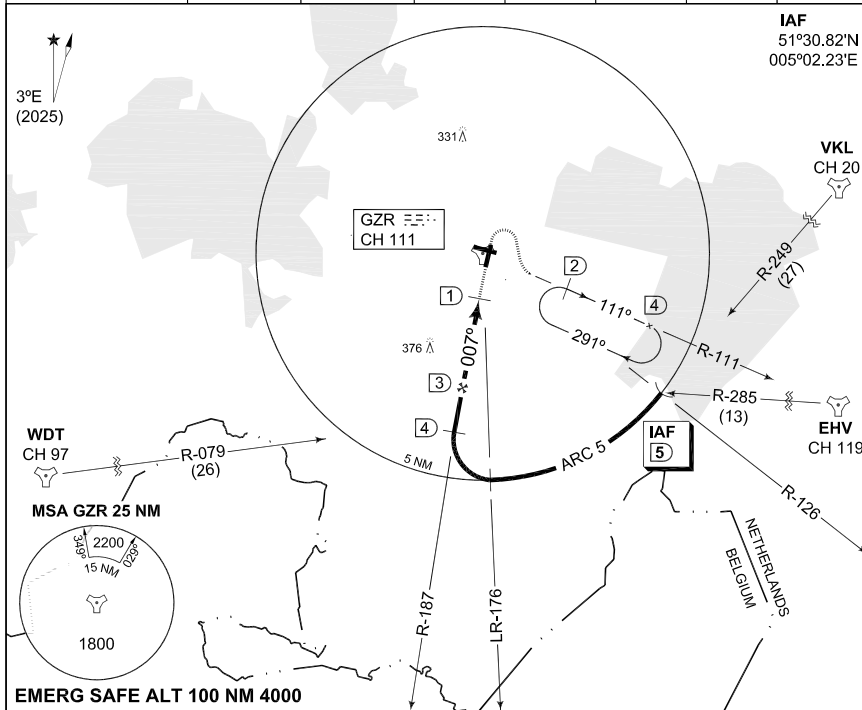

IAF
51°30.82'N
005°02.23'E

EMERG SAFE ALT 100 NM 4000

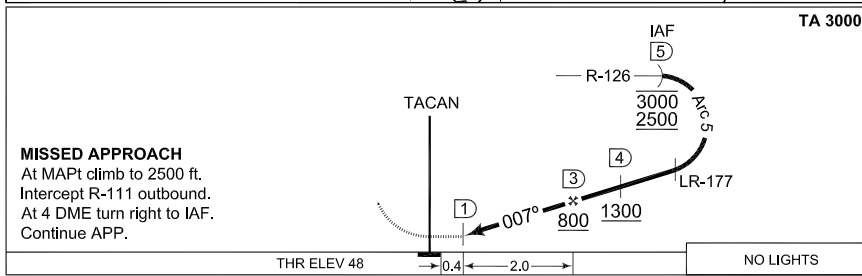

MISSED APPROACH
At MAPt climb to 2500 ft.
Intercept R-111 outbound.
At 4 DME turn right to IAF.
Continue APP.

CATEGORY	COPTER	THR ELEV 48	NO LIGHTS
S-TACAN 007	460-800 412 (500-0.8)	0.4	
CIRCLING	540-1900 491 (500-1.9)	2.0	

COPTER TACAN 007

51°34.04'N
004°55.91'E

GILZE-RIJEN (EHGR)

CHANGES: EDITORIAL

MIPS

RNLASF 16 APR 2026

MIPS
INSTRUMENT APPROACH CHART

HI-TACAN RWY 10
GILZE-RIJEN (EHGR)

AD ELEV 49

DUTCH MIL 336.325 125.930		RAPCON WEST 399.725 123.580		GILZE-RIJEN TWR 277.350 125.330		GND CTL 278.125 123.300	
TACAN GZR CH 111	APP COURSE 100°	FAF 1500 FT	Descent GR	MDA 440	THR ELEV 41	ALS 420 m	LDA 8392 FT

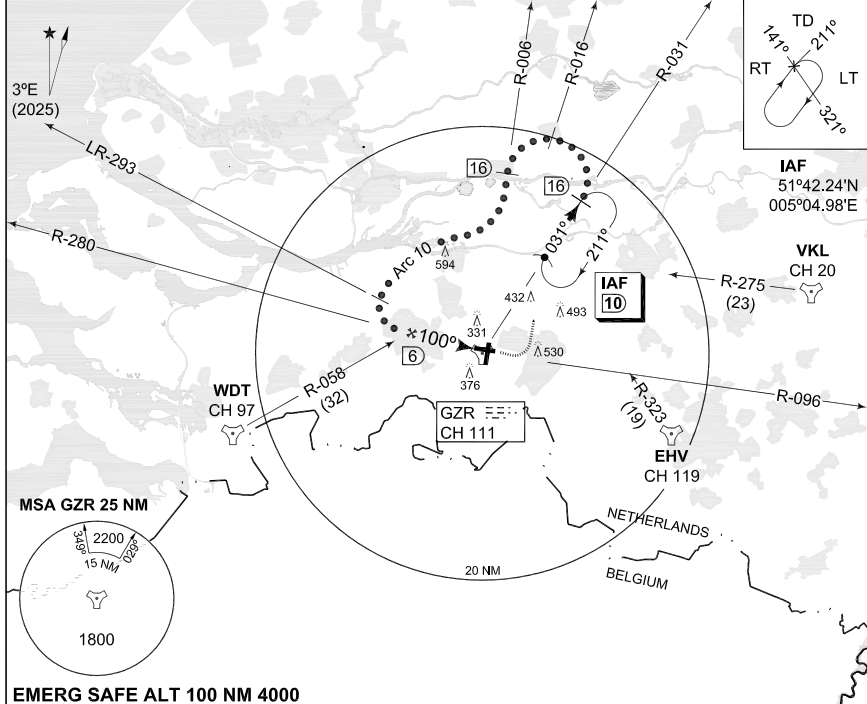

EMERG SAFE ALT 100 NM 4000

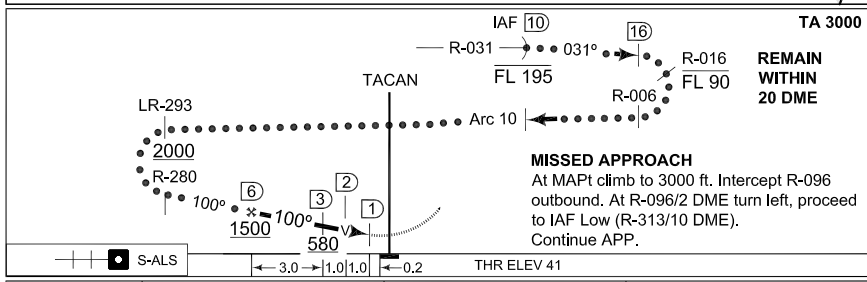

S-ALS	← 3.0 → 1.0 1.0 0.2	THR ELEV 41
-------	---------------------------	-------------

CATEGORY	C	D	E
MINIMA ACCORDING TO PANS-OPS; NOT ACCORDING TO APATC-1			
S-TACAN 10	440 -1.6 399 (400-1.6)		440 -2.0 399 (400-2.0)
CIRCLING	770 -3700 721 (800-3.7)	910 -4600 861 (900-4.6)	1000 -6500 951 (1000-6.5)

HI-TACAN RWY 10

51°34.04'N
004°55.91'E

GILZE-RIJEN (EHGR)

CHANGES: EDITORIAL

RNLASF 16 APR 2026

MIPS
INSTRUMENT APPROACH CHART

TACAN RWY 10
GILZE-RIJEN (EHGR)

AD ELEV 49

DUTCH MIL 336.325 125.930		RAPCON WEST 399.725 123.580		GILZE-RIJEN TWR 277.350 125.330		GND CTL 278.125 123.300	
TACAN GZR CH 111	APP COURSE 100°	FAF ALT 1500 FT	Descent GR	MDA 440	THR ELEV 41	ALS 420 m	LDA 8392 FT

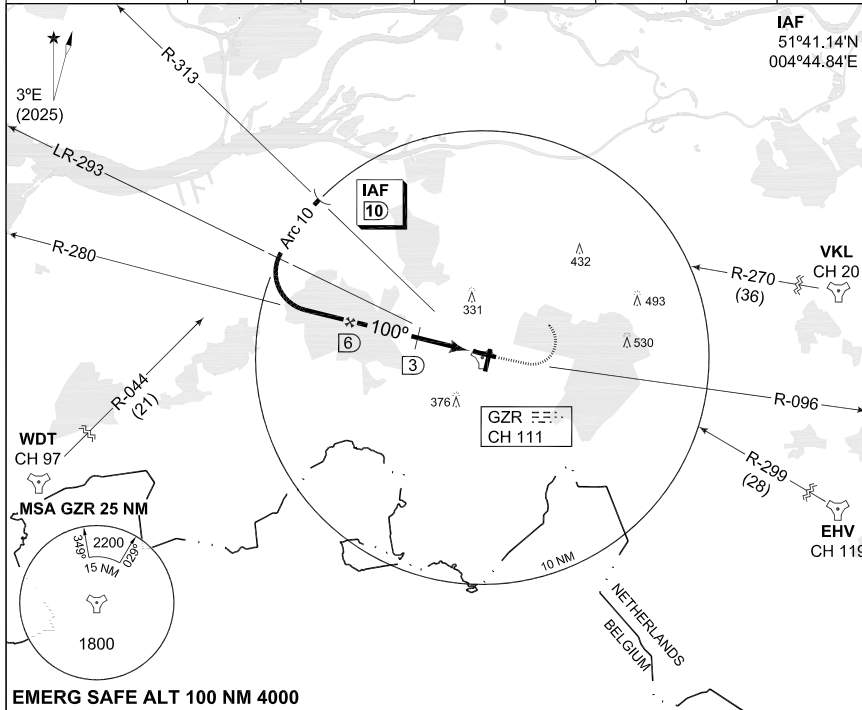

IAF
51°41.14'N
004°44.84'E

EMERG SAFE ALT 100 NM 4000

TA 3000

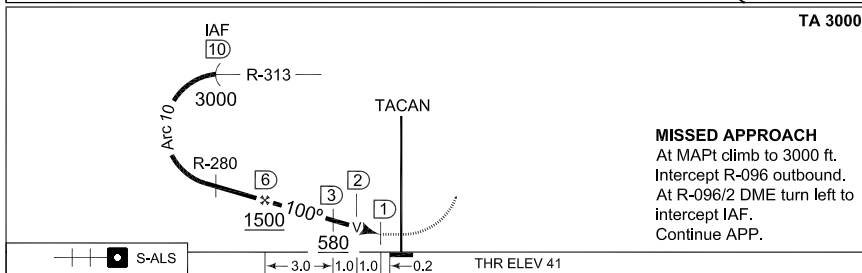

MISSED APPROACH
At MAPT climb to 3000 ft.
Intercept R-096 outbound.
At R-096/2 DME turn left to intercept IAF.
Continue APP.

CATEGORY	A	B	C	D	E
MINIMA ACCORDING TO PANS-OPS; NOT ACCORDING TO APATC-1					
S-TACAN 10	440 -1.6 399 (400-1.6)				440 -2.0 399 (400-2.0)
CIRCLING	540 -1900 491 (500-1.9)	670 -2800 621 (700-2.8)	770 -3700 721 (800-3.7)	910 -4600 861 (900-4.6)	1000 -6500 951 (1000-6.5)

TACAN RWY 10

51°34.04'N
004°55.91'E

GILZE-RIJEN (EHGR)

CHANGES: EDITORIAL
MIPS

RNLASF: 16 APR 2026

MIPS INSTRUMENT APPROACH CHART

AD ELEV 49

COPTER TACAN 100 GILZE-RIJEN (EHGR)

DUTCH MIL 336.325 125.930		RAPCON WEST 399.725 123.580		GILZE-RIJEN TWR 277.350 125.330		GND CTL 278.125 123.300	
TACAN GZR CH 111	APP COURSE 100°	FAF 1000 FT	Descent GR	MDA 440	THR ELEV 41	ALS 420 m	LDA 8392 FT

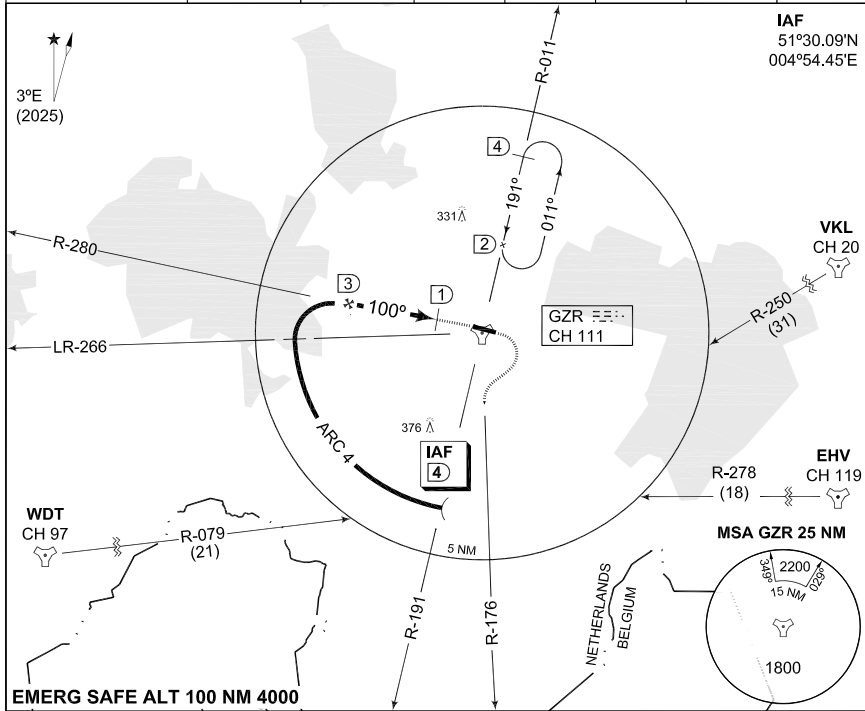

EMERG SAFE ALT 100 NM 4000

TA 3000

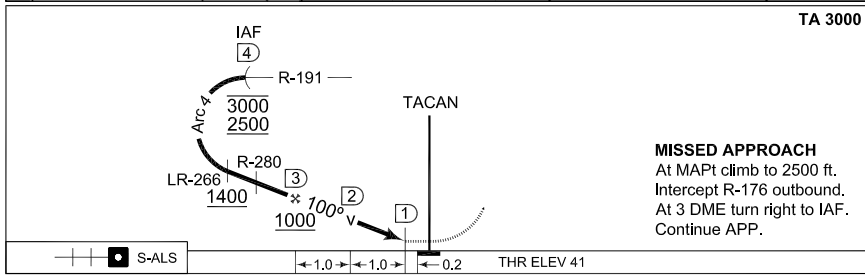

MISSED APPROACH
At MAPt climb to 2500 ft.
Intercept R-176 outbound.
At 3 DME turn right to IAF.
Continue APP.

+	+	+	+	S-ALS	← 1.0	← 1.0	← 0.2	THR ELEV 41
---	---	---	---	-------	-------	-------	-------	-------------

CATEGORY	COPTER
S-TACAN 100	440-400 399 (400-0.4)
CIRCLING	540-1900 491 (500-1.9)

COPTER TACAN 100

51°34,04'N
004°55,91'E

GILZE-RIJEN (EHGR)

CHANGES: EDITORIAL

MIPS

RNLASF 16 APR 2026

MIPS INSTRUMENT APPROACH CHART

AD ELEV 49

COPTER TACAN 203 GILZE-RIJEN (EHGR)

DUTCH MIL 336.325 125.930		RAPCON WEST 399.725 123.580		GILZE-RIJEN TWR 277.350 125.330		GND CTL 278.125 123.300	
TACAN GZR CH 111	APP COURSE 203°	FAF 1000 FT	Descent GR	MDA 420	THR ELEV 36	ALS -	LDA 6181 FT

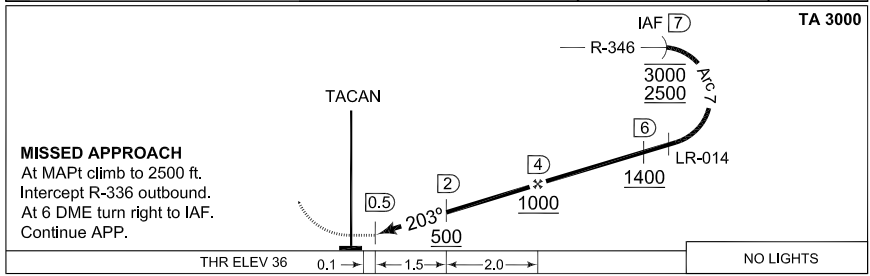
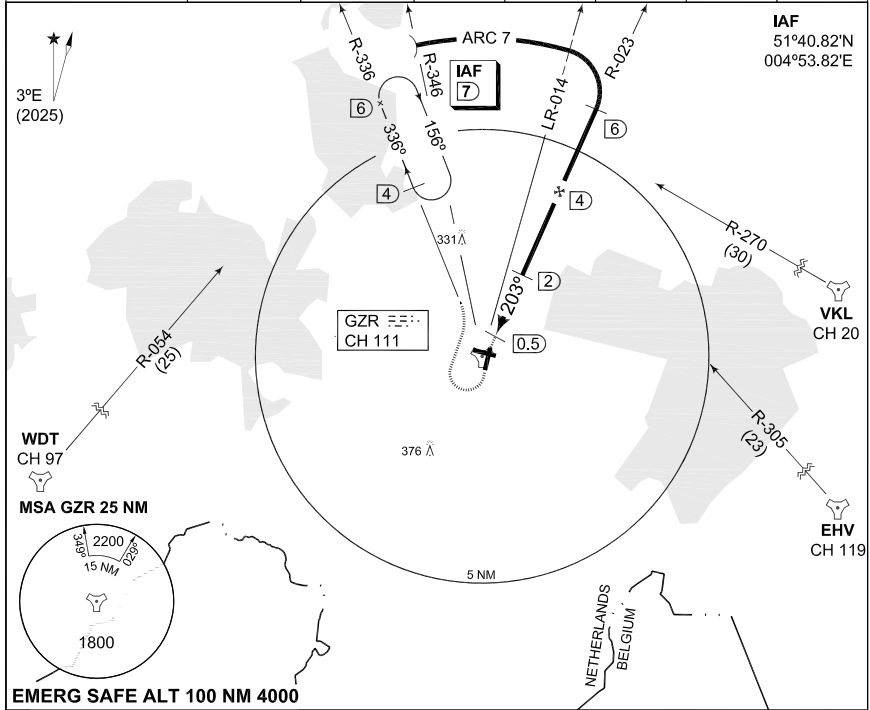

CATEGORY	COPTER
S-TACAN 203	420-800 384 (400-0.8)
CIRCLING	540-1900 491 (500-1.9)

COPTER TACAN 203

51°34.04'N
004°55.91'E

GILZE-RIJEN (EHGR)

CHANGES: EDITORIAL

MIPS

RNLASF 16 APR 2026

MIPS
INSTRUMENT APPROACH CHART

ILS or LOC RWY 28
GILZE-RIJEN (EHGR)

AD ELEV 49

DUTCH MIL 336.325 125.930		RAPCON WEST 399.725 123.580		GILZE-RIJEN TWR 277.350 125.330		GND CTL 278.125 123.300			
TACAN / LOCALIZER / DME GZR CH 111/GZO 111.900/CH 56X			APP COURSE 278°	GS INTCP ALT 1500 FT	GS 3°	MDA SEE CAT	THR ELEV 35	ALS 780 m	LDA 8806 FT

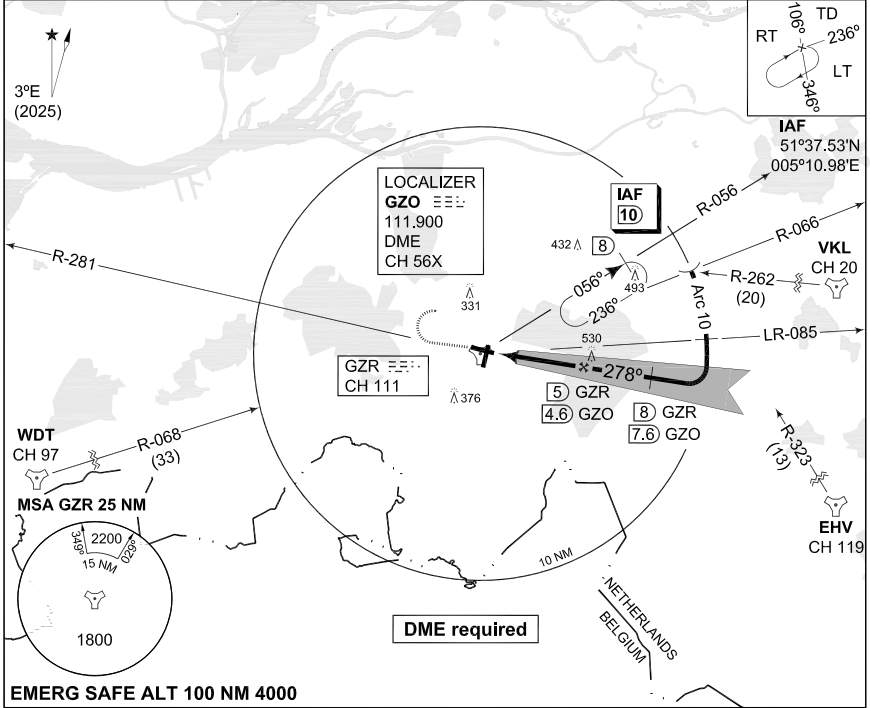

EMERG SAFE ALT 100 NM 4000

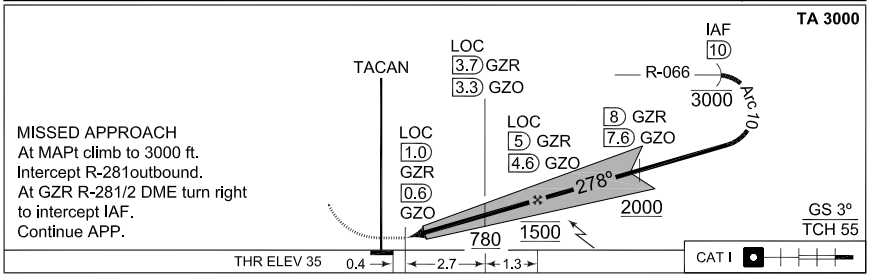

MISSED APPROACH
At MAPt climb to 3000 ft.
Intercept R-281 outbound.
At GZR R-281/2 DME turn right to intercept IAF.
Continue APP.

CATEGORY	COPTER	A	B	C	D
ILS MINIMA ACCORDING TO PANS-OPS; NOT ACCORDING TO APATC-1					
S-ILS 28	235 -400 200 (200-0.4)	235 -800 200 (200-0.8)			245 -800 210 (300-0.8)
S-LOC 28	380 -400 345 (400-0.4)	380 -1200 345 (400-1.2)			
CIRCLING	540 -1900 491 (500-1.9)	670 -2800 621 (700-2.8)	770 -3700 721 (800-3.7)	910 -4600 861 (900-4.6)	

ILS or LOC RWY 28

51°34.04'N
004°55.91'E

GILZE-RIJEN (EHGR)

CHANGES: EDITORIAL

MIPS

RNLASF 16 APR 2025

MIPS

INSTRUMENT APPROACH CHART

AD ELEV 49

**HI-TACAN RWY 28
GILZE-RIJEN (EHGR)**

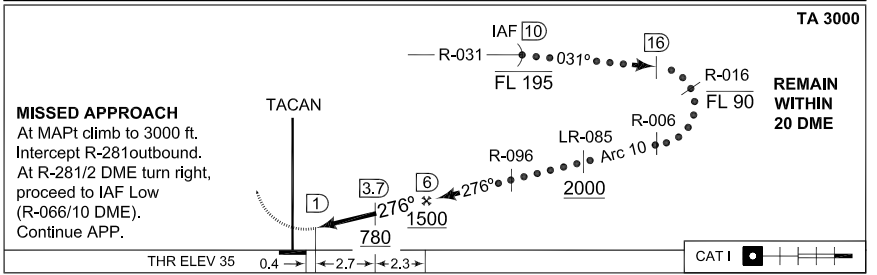
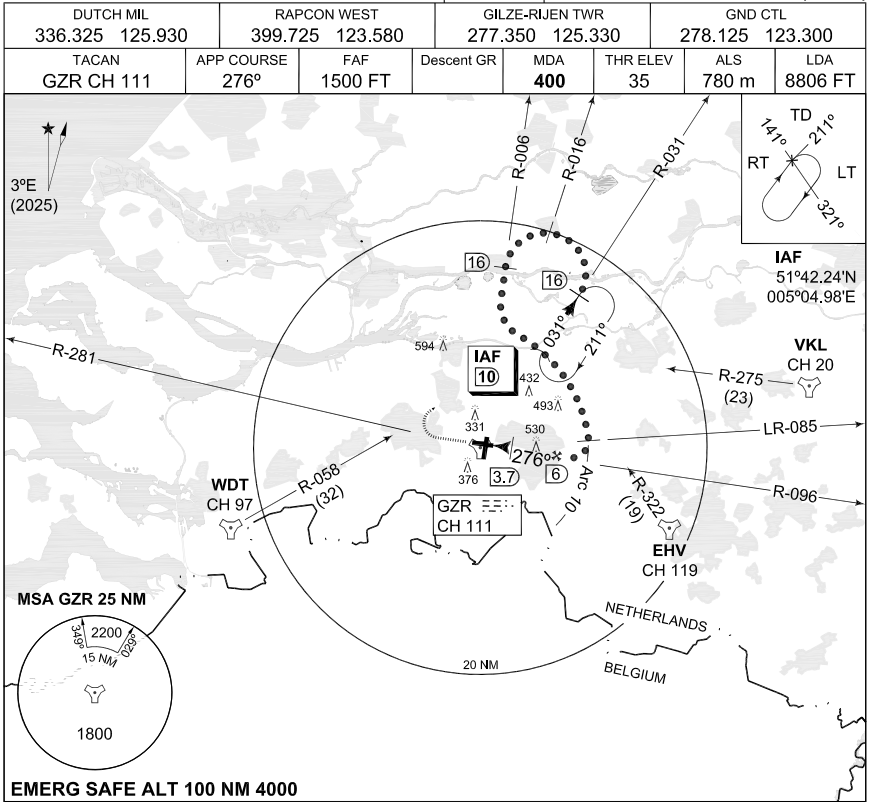

CATEGORY	C		D		E
	MINIMA ACCORDING TO PANS-OPS; NOT ACCORDING TO APATC-1				
S-TACAN 28	400-800 365 (400-0.8)		400-1200 365 (400-1.2)		
CIRCLING	770-3700 721 (800-3.7)		910-4600 861 (900-4.6)		1000-6500 951 (1000-6.5)

HI-TACAN RWY 28

51°34.04'N
004°55.91'E

GILZE-RIJEN (EHGR)

CHANGES: EDITORIAL

MIPS

RNLASF 16 APR 2026

MIPS
INSTRUMENT APPROACH CHART

TACAN RWY 28
GILZE-RIJEN (EHGR)

AD ELEV 49

DUTCH MIL 336.325 125.930		RAPCON WEST 399.725 123.580		GILZE-RIJEN TWR 277.350 125.330		GND CTL 278.125 123.300	
TACAN GZR CH 111	APP COURSE 276°	FAF 1500 FT	Descent GR	MDA 400	THR ELEV 35	ALS 780 m	LDA 8806 FT

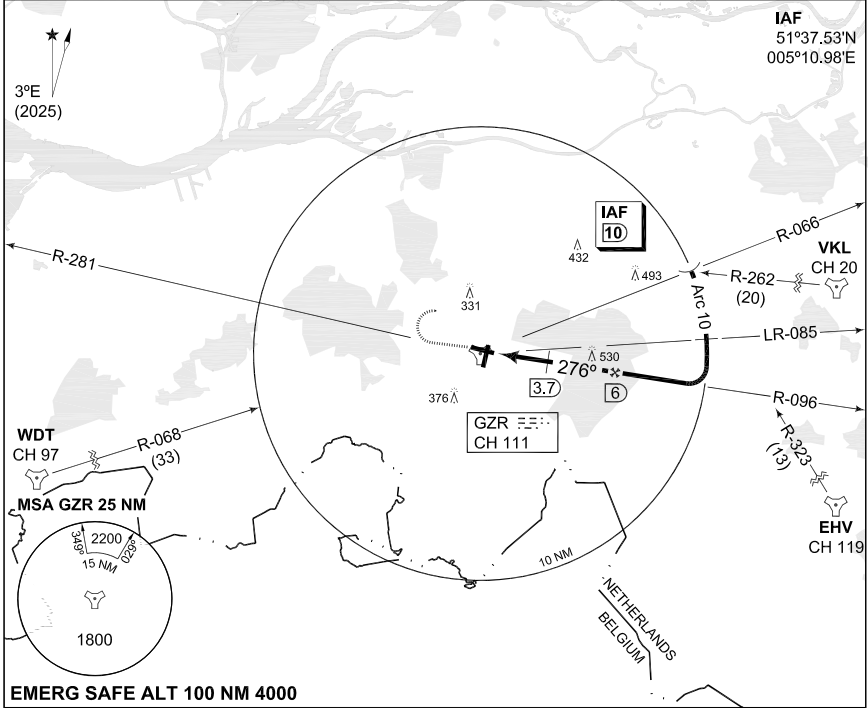

IAF
51°37.53'N
005°10.98'E

EMERG SAFE ALT 100 NM 4000

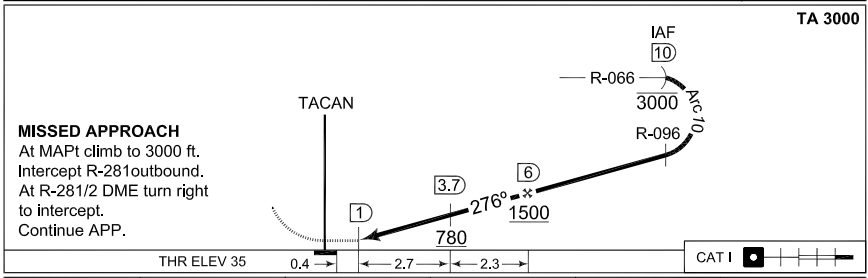

TA 3000

CATEGORY	A	B	C	D	E
MINIMA ACCORDING TO PANS-OPS; NOT ACCORDING TO APATC-1					
S-TACAN 28	400-800 365 (400-0.8)			400-1200 365 (400-1.2)	
CIRCLING	540-1900 491 (500-1.9)	670-2800 621 (700-2.8)	770-3700 721 (800-3.7)	910-4600 861 (900-4.6)	1000-6500 951 (1000-6.5)

TACAN RWY 28

51°34.04'N
004°55.91'E

GILZE-RIJEN (EHGR)

CHANGES: EDITORIAL
MIPS

RNLASF 16 APR 2026

MIPS
INSTRUMENT APPROACH CHART

COPTER TACAN 276
GILZE-RIJEN (EHGR)

AD ELEV 49

DUTCH MIL 336.325 125.930		RAPCON WEST 399.725 123.580		GILZE-RIJEN TWR 277.350 125.330		GND CTL 278.125 123.300	
TACAN GZR CH 111	APP COURSE 276°	FAF 1100 FT	Descent GR	MDA 420	THR ELEV 35	ALS 780 m	LDA 8806 FT

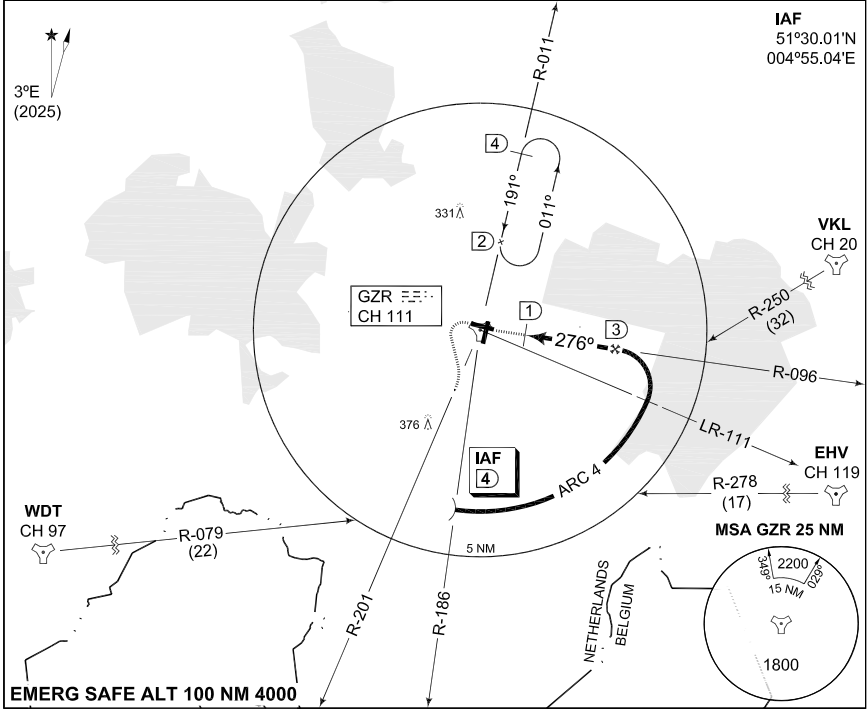

EMERG SAFE ALT 100 NM 4000

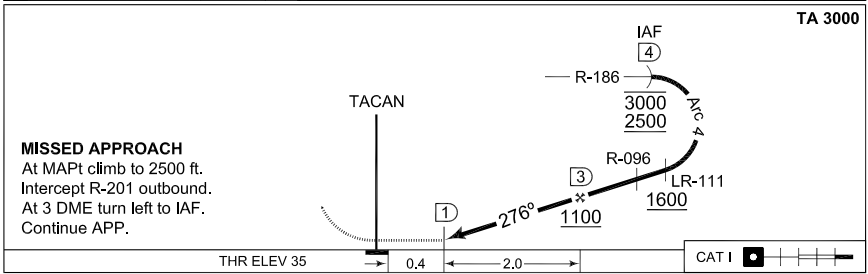

MISSED APPROACH
At MAPt climb to 2500 ft.
Intercept R-201 outbound.
At 3 DME turn left to IAF.
Continue APP.

THR ELEV 35	0.4	2.0	CAT I
CATEGORY	COPTER		
S-TACAN 276	420-400 385 (400-0.4)		
CIRCLING	540-1900 491 (500-1.9)		

CHANGES: EDITORIAL

COPTER TACAN 276

51°34.04'N
004°55.91'E

GILZE-RIJEN (EHGR)

RNLASF 16 APR 2026

AERODROME CHART

KARUP AIR BASE (EKKA)

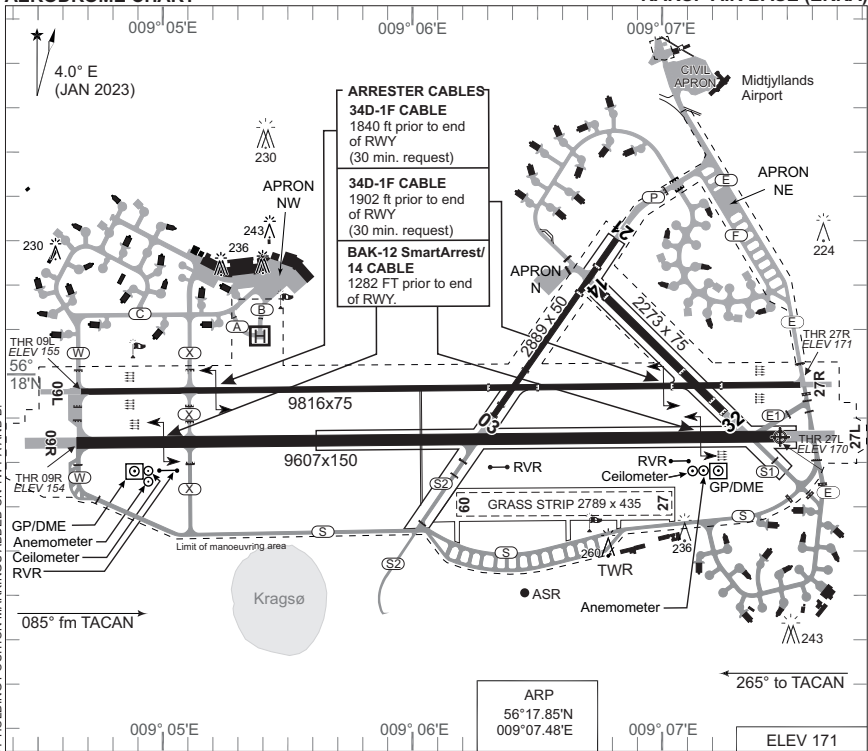

RWY	PCN	PCR	DECLARED DISTANCES					THR ELEV	THR PSN
			TORA	TODA	ASDA	LDA	PAPI		
09R	75 F/C/W/T	530 R/B/W/T	9607	9607	10352	9607	3.00°	154	56°17.84'N 009°04.64'E
27L	75 F/C/W/T	530 R/B/W/T	9607	9607	10352	9607	3.00°	170	56°17.85'N 009°07.48'E
09L	120 F/B/W/T	390 F/B/X/T	9816	9816	10389	9816	3.00°	154	56°17.95'N 009°04.66'E
27R	120 F/C/W/T	390 F/B/X/T	9816	9816	10282	9816	3.00°	171	56°17.96'N 009°07.56'E

Noise abatement procedures:
 RWY 27L/R: None.
 RWY 09R/L: Noise abatement procedure for all jet aircraft and for propeller and turboprop aircraft MTOW above 5700 kg for departure or missed approach RWY 09R/L.
 VMC: Avoid overflying the towns/villages Karup and Kolvrå below 2000 feet MSL.
 IMC: Turn must not be commenced before DME KAR (CH 37x) 6.5 NM (or DME KAP (CH20y) 4.0 NM) or 2000 feet AMSL, whichever comes first.

Afterburner/reheat must be cut off before reaching the NE/SW going main road (Viborg - Herring) just east of the airfield.

Omnidirectional departures all runways:
 Climb straight ahead to at least 850 FT AMSL before turn is commenced.

PAR	PROC. CRITERIA	RWY	GS	TCH	OTCH	RPI	CAT	MINIMA CRITERIA	MINIMA
	INTENTIONALLY LEFT BLANK								
SRA	INTENTIONALLY LEFT BLANK								

PAR	PROC. CRITERIA	RWY	GS	TCH	OTCH	RPI	CAT	MINIMA CRITERIA	MINIMA
	INTENTIONALLY LEFT BLANK								
SRA	INTENTIONALLY LEFT BLANK								

AERODROME CHART

KARUP AIR BASE (EKKA)

CHANGES: INTERMEDIATE HOLDING POSITIONS ADDED NW AND SE OF TWY P. RWY. HOLDING POSITION MARKINGS ADDED ON TWY A AND B.

AIR COMMAND DENMARK - MIL-AIM 16 APR 2026

MIPS

INSTRUMENT APPROACH CHART

AD ELEV 171

ILS or LOC RWY 09R
KARUP AIR BASE (EKKA)

COPENHAGEN CONTROL 242.650 124.555		KARUP ATIS 120.580		KARUP APPROACH 269.275 120.430			KARUP TOWER 353.575 119.580	
LOC/DME KAP 108.300/CH20X		APP COURSE 085°	GS INTCP ALT 2000 FT	GS 3.00°	DA 354	THR ELEV 154	ALS LENGTH 900 M	LDA 9607 FT

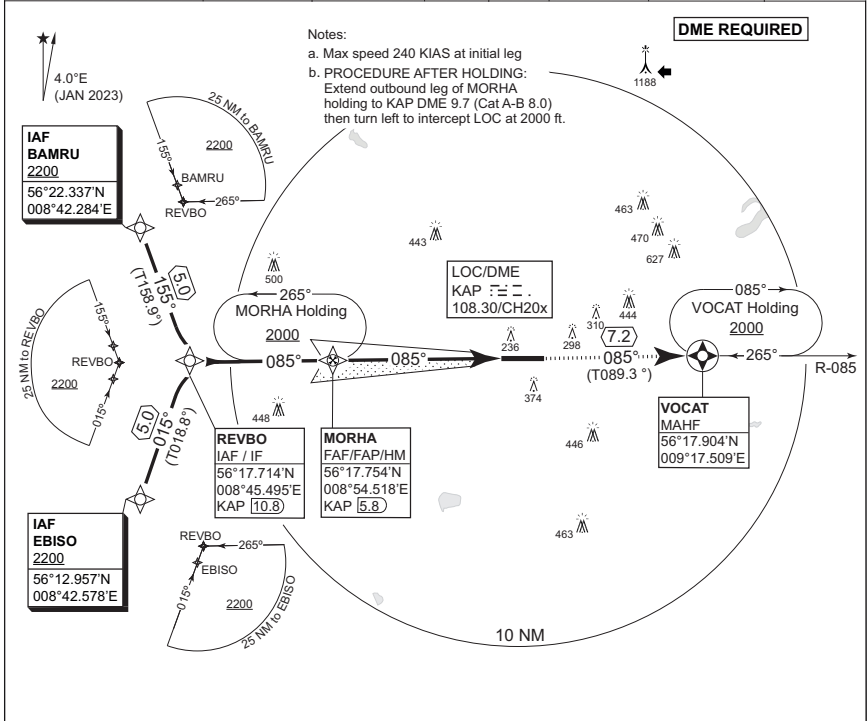

TA 3000	IAF / IF REVBO	FAF MORHA	LOC ONLY	LOC ONLY: CDFA 3.00° / 5.24%					
GS 3.0°	KAP 10.8	KAP 5.8	KAP 4.0	DME KAP	5	4	3	2	1
RDH 50				DIST THR	4.8	3.8	2.8	1.8	0.8
				ALT	1750	1430	1110	790	470

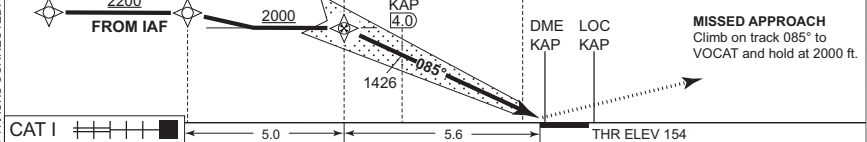

CATEGORY	A	B	C	D	E
S-ILS CAT I			354 - 550 200 (200-0.8/1.2)		
S-LOC 09R			470 - 750 316 (400-0.8/1.4)		
CIRCLING	670 - 1.5 499 (500-1.5)	680 - 1.6 509 (600-1.6)	840 - 2.4 669 (700-2.4)	880 - 3.6 709 (800-3.6)	1120 - 3.6 949 (1000-3.6)

ILS or LOC RWY 09R

56°17.85'N
009°07.48'E

KARUP AIR BASE (EKKA)

CHANGES: MULTIPLE MAGNETIC TRACKS CORRECTED.

AIR COMMAND DENMARK - MIL AIR 19 FEB 2025

COPENHAGEN CONTROL 242.650 124.555		KARUP ATIS 120.580	KARUP APPROACH 269.275 120.430		KARUP TOWER 353.575 119.580		
TACAN KAR CH 37x	APP COURSE 085°	FAF ALT 2000 FT	DESCENT GR. 5.24% (318 FT/NM)	MDA 500	THR ELEV 154	ALS LENGTH 900 M	LDA 9607 FT

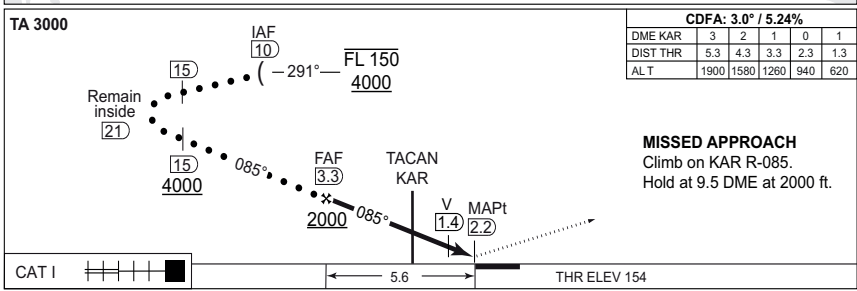
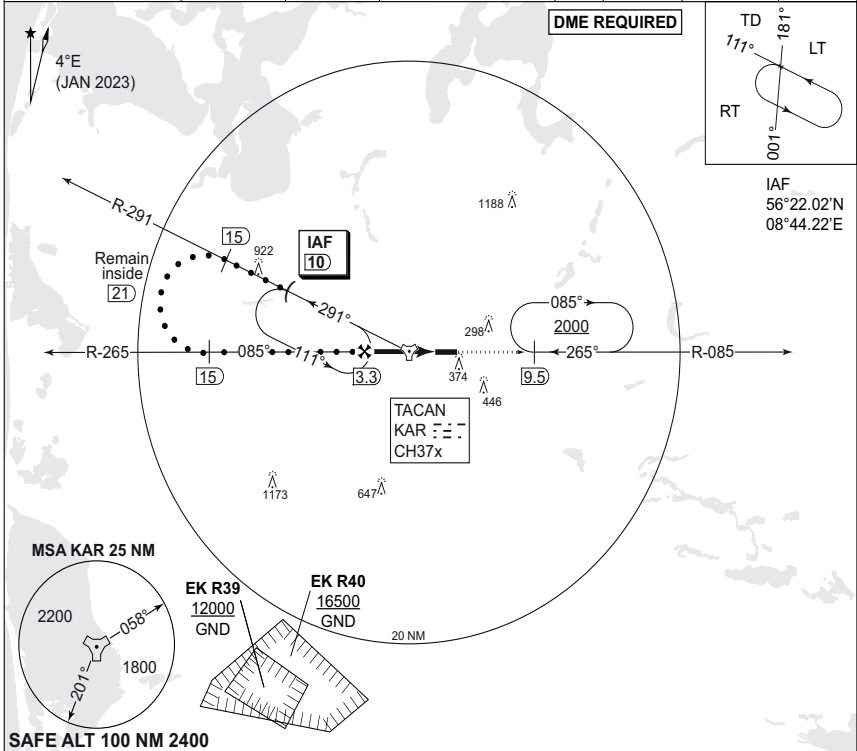

CATEGORY	HPMA
S-TACAN 09R	500 - 900 346 (400-0.9/1.6)
CIRCLING	750 - 3.2 579 (600-3.2)

MIPS INSTRUMENT APPROACH CHART

AD ELEV 171

RNP RWY 09R KARUP AIR BASE (EKKA)

COPENHAGEN CONTROL 242.650 124.555		KARUP ATIS 120.580		KARUP APPROACH 269.275 120.430		KARUP TOWER 353.575 119.580	
EGNOS CHANNEL 46175 / E09A	APP COURSE 085°	FAF ALT 2000 FT	Descent GR 3.0° (5.24%)	MINIMA See CAT	THR ELEV 154	ALS length 900 M	LDA 9607 FT

Note 1: Max speed 250 KIAS
 Note 2: PAPI and RNAV glidepath not coincident (PAPI angle 3.00° / TCH 50)

RNP APCH

a Not to be used below -25°C

★
4.0°E
(JAN 2023)

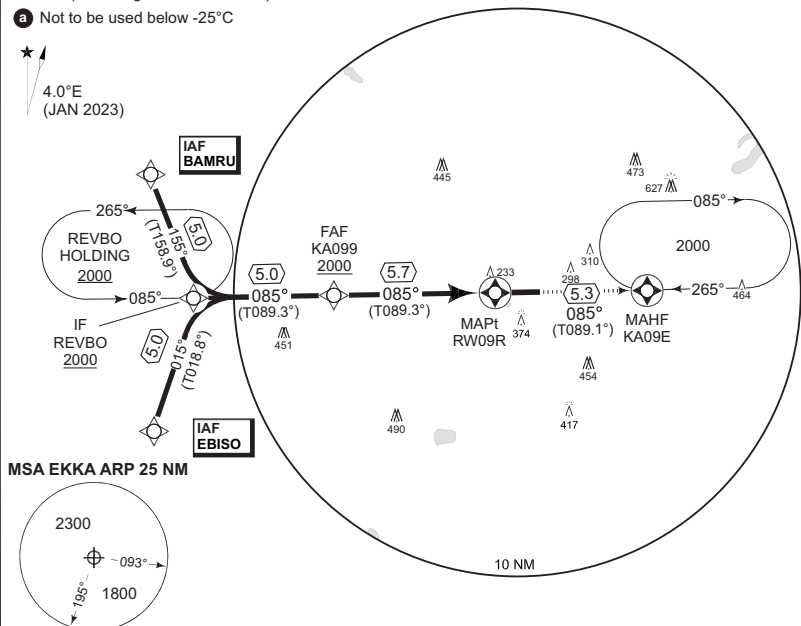

MSA EKKA ARP 25 NM

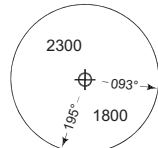

SAFE ALT 100NM 2400

TA 3000 GS 3.0° TCH 41.5	DIST TO RW09R	5	4	3	2	1
	NOM. ALTITUDE	1790	1470	1150	830	520

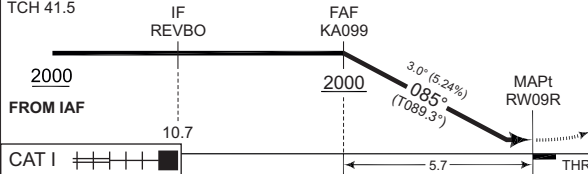

MISSED APPROACH RNAV
 Climb on track to overfly KA09E and hold at 2000 ft.
 RW09R - KA09E [A2000+·HM]

CATEGORY	A	B	C	D	E
LPV (DA)	404 - 600 250 (300-0.8/1.3)				
LNAV/VNAV (DA) a	454 - 650 300 (300-0.8/1.4)				
LNAV (MDA)	490 - 800 336 (400-0.8/1.5)				500 - 900 346 (400-0.9/1.6)
CIRCLING	670 - 1.5 499 (500-1.5)	680 - 1.6 509 (600-1.6)	850 - 2.4 679 (700-2.4)	880 - 3.6 709 (800-3.6)	1120 - 3.6 949 (1000-3.6)

RNP RWY 09R

56°17.85'N
009°07.48'E

KARUP AIR BASE (EKKA)

CHANGES: MULTIPLE MAGNETIC TRACKS CORRECTED

AIR COMMAND DENMARK - MIL AIM 19 FEB 2026

EKKA RNP RWY 09R waypoint coordinates:

RWY 09R from BAMRU APPROACH RNP

		CODING				DISPLAY	
BAMRU	IAF	56 22 20.21N	008 42 17.04E	56 22.337°N	008 42.284°E		
REVBO	IF	56 17 42.82N	008 45 29.70E	56 17.714°N	008 45.495°E		
KA099	FAF	56 17 46.08N	008 54 28.08E	56 17.768°N	008 54.468°E		
RW09R	MAPt	56 17 49.74N	009 04 38.39E	56 17.829°N	009 04.640°E		
KA09E	MAHF	56 17 54.42N	009 14 13.05E	56 17.907°N	009 14.217°E		

RWY 09R from EBISO APPROACH RNP

		CODING				DISPLAY	
EBISO	IAF	56 12 57.40N	008 42 34.70E	56 12.957°N	008 42.578°E		
REVBO	IF	56 17 42.82N	008 45 29.70E	56 17.714°N	008 45.495°E		
KA099	FAF	56 17 46.08N	008 54 28.08E	56 17.768°N	008 54.468°E		
RW09R	MAPt	56 17 49.74N	009 04 38.39E	56 17.829°N	009 04.640°E		
KA09E	MAHF	56 17 54.42N	009 14 13.05E	56 17.907°N	009 14.217°E		

Threshold coordinates RWY 09R

		CODING		DISPLAY	
RWY 09R		56 17 49.74N	009 04 38.39E	56 17.829°N	009 04.640°E

MIPS
INSTRUMENT APPROACH CHART

AD ELEV 171

ILS or LOC RWY 27L
KARUP AIR BASE (EKKA)

COPENHAGEN CONTROL 242.650 124.555		KARUP ATIS 120.580		KARUP APPROACH 269.275 120.430		KARUP TOWER 353.575 119.580	
LOC/DME KR 108.150/CH18y		APP COURSE 265°	GS INTCP ALT 2000 FT	GS 3.00°	DA 370	THR ELEV 170	ALS LENGTH 900 M
							LDA 9607 FT

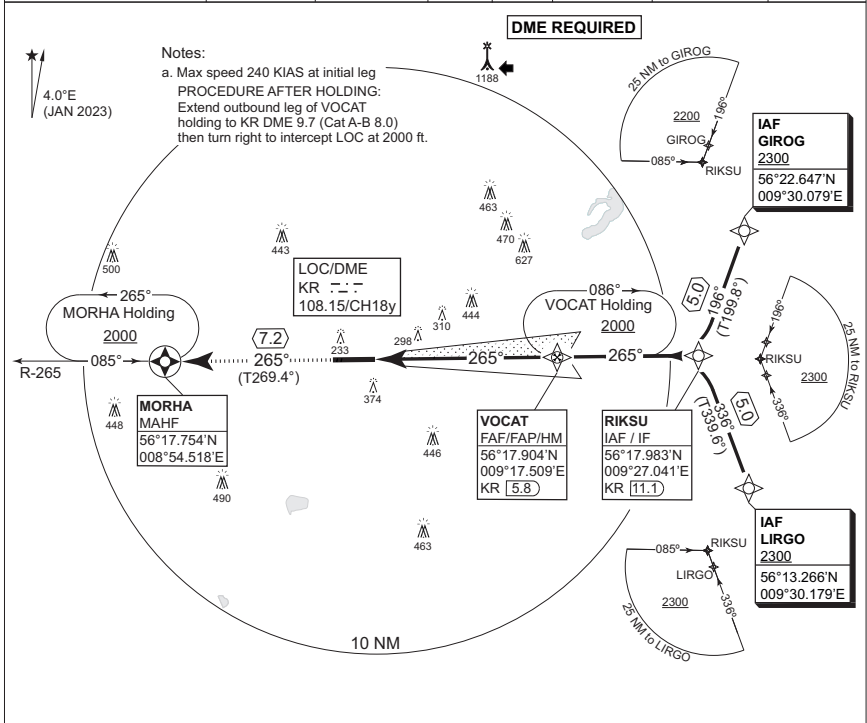

LOC ONLY: CDFA 3.00" / 5.24%					MAP Pt KR 0.6	FAF VOCAT KR 5.8	IAF / IF RIKSU KR 11.1	TA 3000 GS 3.0° RDH 50	
DME KR	1	2	3	4					5
DIST THR	0.8	1.8	2.8	3.8					4.8
ALT	490	810	1120	1440	1760	SDF KR 2.3		FROM IAF	

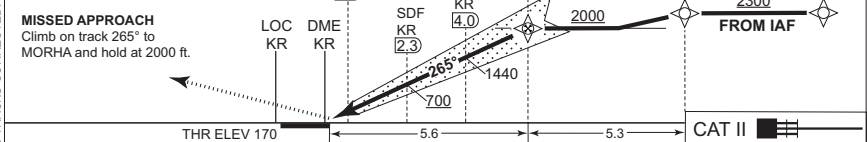

CATEGORY	A	B	C	D	E
S-ILS CAT I	370 - 550 200 (200-0.8/1.2)				
S-ILS CAT II	RA 106 (DA 270) - 350 100				N/A
S-LOC 27L	480 - 750 310 (400-0.8/1.4)				
CIRCLING	670 - 1.5 499 (500-1.5)	680 - 1.6 509 (600-1.6)	840 - 2.4 669 (700-2.4)	880 - 3.6 709 (800-3.6)	1120 - 3.6 949 (1000-3.6)

ILS or LOC RWY 27L

56°17.85'N
009°07.48'E

KARUP AIR BASE (EKKA)

CHANGES: MULTIPLE MAGNETIC TRACKS CORRECTED.

AIR COMMAND DENMARK - MIL AIM 19 FEB 2026

MIPS

INSTRUMENT APPROACH CHART

AD ELEV 171

**HPMA TACAN RWY 27L
KARUP AIR BASE (EKKA)**

COPENHAGEN CONTROL 242.650 124.555		KARUP ATIS 120.580		KARUP APPROACH 269.275 120.430		KARUP TOWER 353.575 119.580	
TACAN KAR CH 37x	APP COURSE 265°	FAF ALT 2000 FT	DESCENT GR. 5.24% (318 FT/NM)		MDA 560	THR ELEV 170	LDA 9607 FT

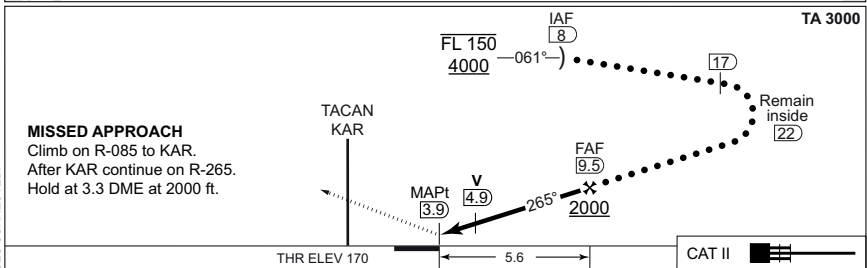
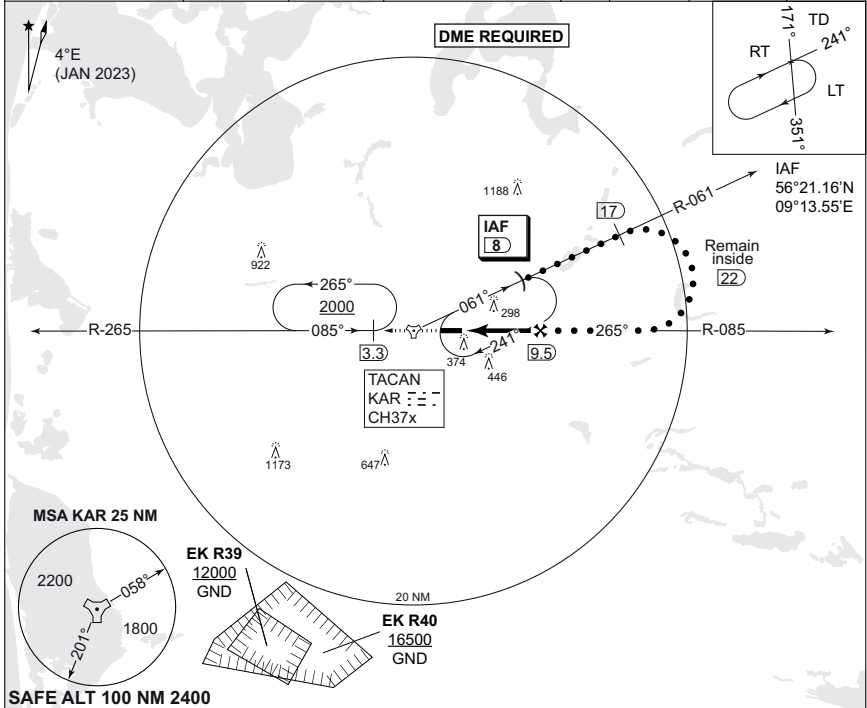

CATEGORY	HPMA
S-TACAN 27L	560 - 1100 389 (400-1.1/1.8)
CIRCLING	750 - 3.2 579 (600-3.2)

HPMA TACAN RWY 27L

56°17.85'N
009°07.48'E

KARUP AIR BASE (EKKA)

CHANGES: MULTIPLE COURSES CORRECTED.

MIPS

AIR COMMAND DENMARK - MIL-AIM 19 FEB 2026

MIPS
INSTRUMENT APPROACH CHART

AD ELEV 171

RNP RWY 27L
KARUP AIR BASE (EKKA)

COPENHAGEN CONTROL 242.650 124.555		KARUP ATIS 120.580		KARUP APPROACH 269.275 120.430		KARUP TOWER 353.575 119.580	
EGNOS CHANNEL 54104 / E27A	APP COURSE 265°	FAF ALT 2000 FT	Descent GR 3.0° (5.24%)	MINIMA See CAT	THR ELEV 170	ALS length 900 M	LDA 9607 FT

Note 1: Max speed 250 KIAS
Note 2: PAPI and RNAV glidepath not coincident
(PAPI angle 3.00° / TCH 50)

RNP APCH

a Not to be used below -25°C

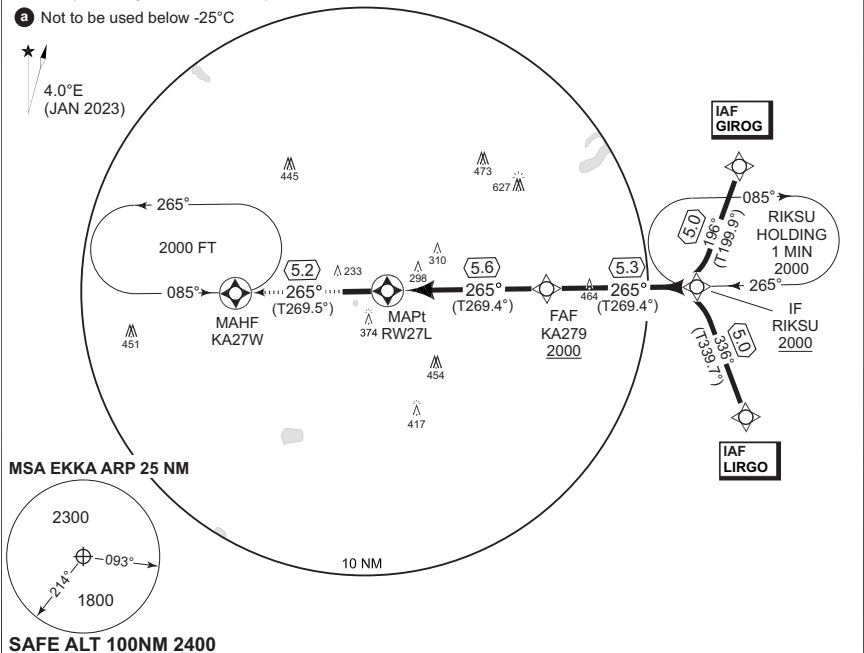

SAFE ALT 100NM 2400

DIST TO RW27L	1	2	3	4	5
NOM. ALTITUDE	530	850	1170	1490	1800

TA 3000
GS 3.0°
TCH 39.3

MISSED APPROACH

Climb on track to overfly
KA27W and hold at 2000 ft.
RW27L - KA27W [A2000+,HM]

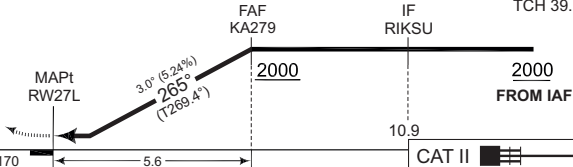

CHANGES: MULTIPLE MAGNETIC TRACKS CORRECTED.

AIR COMMAND DENMARK - MIL AIM 19 FEB 2026

CATEGORY	A	B	C	D	E	
LPV (DA)		420 - 600 250 (300-0.8/1.3)				
LNAV/VNAV (DA) a		500 - 800 330 (400-0.8/1.5)				
LNAV (MDA)		510 - 800 340 (400-0.8/1.5)				
CIRCLING	670 - 1.5 499 (500-1.5)	680 - 1.6 509 (600-1.6)	850 - 2.4 679 (700-2.4)	880 - 3.6 709 (800-3.6)	1120 - 3.6 949 (1000-3.6)	

RNP RWY 27L

56°17.85'N
009°07.48'E

KARUP AIR BASE (EKKA)

EKKA RNP RWY 27L waypoint coordinates:

RWY 27L from LIRGO APPROACH RNP

		CODING				DISPLAY	
LIRGO	IAF	56 13 15.94N	009 30 10.73E	56 13.266°N	009 30.179°E		
RIKSU	IF	56 17 59.00N	009 27 02.47E	56 17.983°N	009 27.041°E		
KA279	FAF	56 17 55.06N	009 17 34.22E	56 17.918°N	009 17.570°E		
RW27L	MAPt	56 17 50.85N	009 07 28.66E	56 17.847°N	009 07.478°E		
KA27W	MAHF	56 17 47.51N	008 58 06.53E	56 17.792°N	008 58.109°E		

RWY 27L from GIROG APPROACH RNP

		CODING				DISPLAY	
GIROG	IAF	56 22 38.81N	009 30 04.76E	56 22.647°N	009 30.079°E		
RIKSU	IF	56 17 59.00N	009 27 02.47E	56 17.983°N	009 27.041°E		
KA279	FAF	56 17 55.06N	009 17 34.22E	56 17.918°N	009 17.570°E		
RW27L	MAPt	56 17 50.85N	009 07 28.66E	56 17.847°N	009 07.478°E		
KA27W	MAHF	56 17 47.51N	008 58 06.53E	56 17.792°N	008 58.109°E		

Threshold coordinates RWY 27L

		CODING		DISPLAY	
RWY 27L		56 17 50.85N	009 07 28.66E	56 17.847°N	009 07.478°E

**MIPS
AERODROME CHART**

KJEVIK(ENCN)

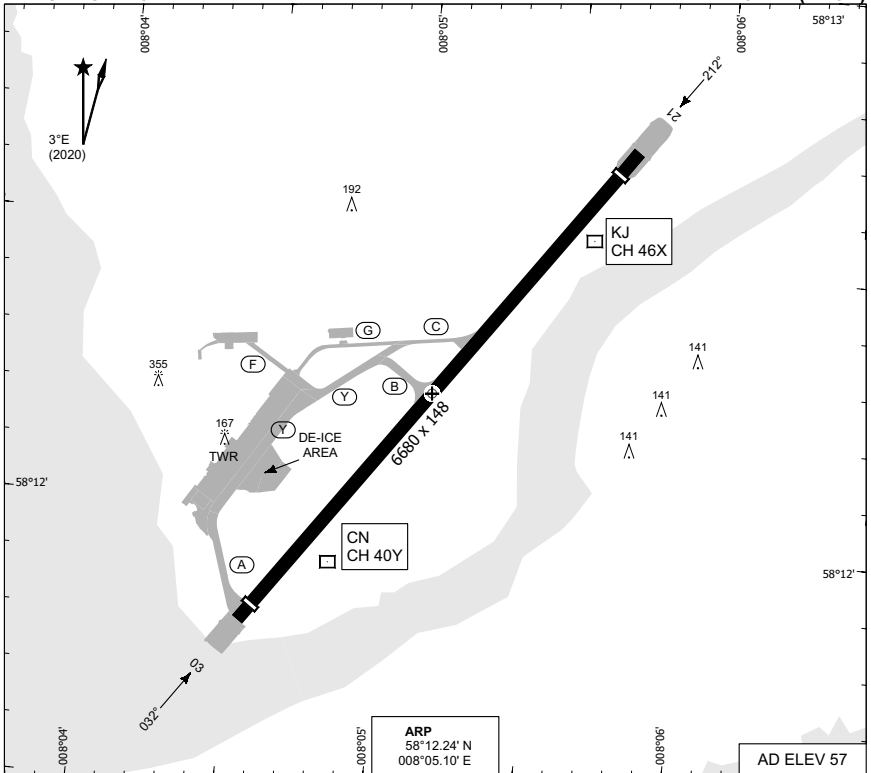

RWY	PCN	TORA	ASDA	TODA	LDA	PAPI	THR ELEV	THR PSN
03	45/F/B/W/U	6519	6519	7087	6299	3.4°	40	58°11.83' N - 008°04.56' E
21	45/F/B/W/U	6460	6460	7034	6135	3.5°	51	58°12.66' N - 008°05.66' E

ATIS
KJEVIK TWR

124.480
118.105 119.955

PROC. CRITERIA	RWY	GS	TCH	OTCH	RPI	CAT	MINIMA CRITERIA	MINIMA

CHANGE: PERIODIC REVIEW

RNOAF 30 OCT 2025

AERODROME CHART

KJEVIK(ENCN)

MIPS
INSTRUMENT APPROACH CHART

ILS M or LOC M RWY 03
KJEVIK(ENCN)

AD ELEV 57

ATIS 124.480		KJEVIK APP 119.955 118.105			KJEVIK TWR 119.955 118.105		
LOC/DME CN 110.350/CH 40Y	APP COURSE 032°	GS INTCP ALT 3000	GS 3.4°	DA See CAT	THR ELEV 40	ALS-LENGTH 900 m	LDA 6300

CAUTION:
a) CIRCLING EAST OF AD ONLY

NOTE:
b) NOISE ABT PROCEDURE:
ACFT ON VISUAL APPROACH
BELOW 1500 FT SHALL FOLLOW
DESCENT PATH NOT LOWER
THAN ILS/PAPI GS

c) DME REQUIRED
d) RADAR VECTORS
TO FINAL REQUIRED

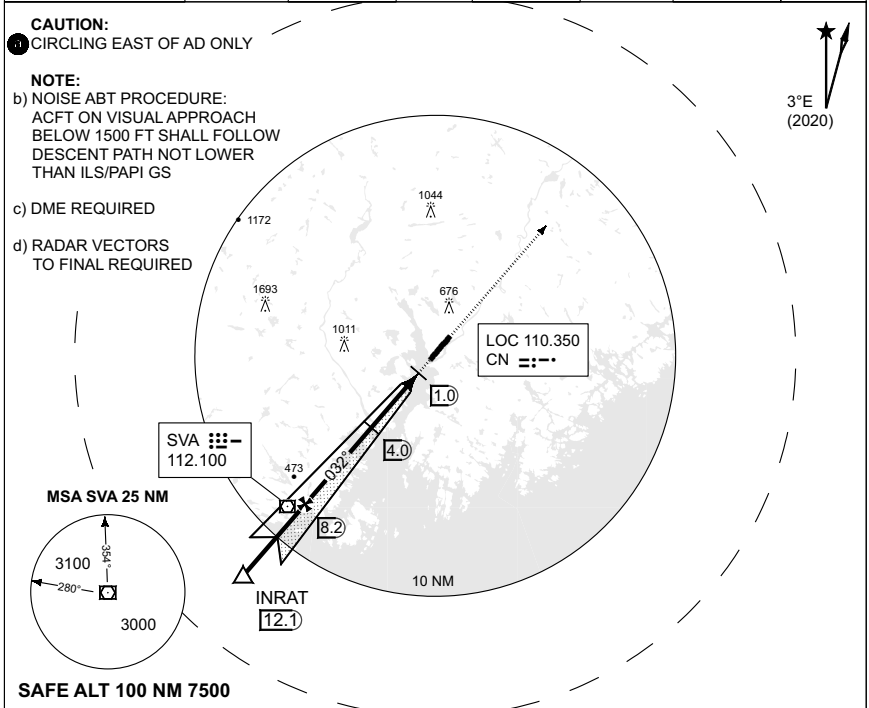

SAFE ALT 100 NM 7500

TA 7000

GP INOP (CDFA 3.4° / 5.94 %)

DME CN (NM)	8	7	6	5	4	3	2
THR 03 (NM)	7.9	6.9	5.9	4.9	3.9	2.9	1.9
ALT	2980	2600	2230	1860	1490	1120	760

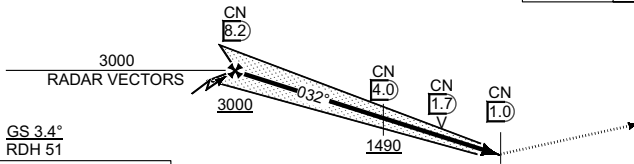

MISSED APPROACH
CLIMB STRAIGHT AHEAD
HDG 032° TO 3000 FT

CAT 1 | 8.1 | THR ELEV 40

CATEGORY	C	D	E
S-ILS	314 - 0.8 274 (300 - 0.8/1.3)	334 - 0.8 294 (300 - 0.8/1.4)	522 - 1.5 482 (500 - 1.5/2.3)
S-LOC	630 - 2.2 590 (600 - 2.2/2.9)		
CIRCLING	1120 - 4.9 1063 (1100 - 4.9)	1310 - 5.0 1253 (1300 - 5.0)	

ILS M or LOC M RWY 03

58°12.24' N
008°05.10' E

KJEVIK(ENCN)

CHANGE COMPLETE REVISION

MIPS

RNAIF 30 OCT 2025

AERODROME CHART

KLEINE-BROGEL (EBBL)

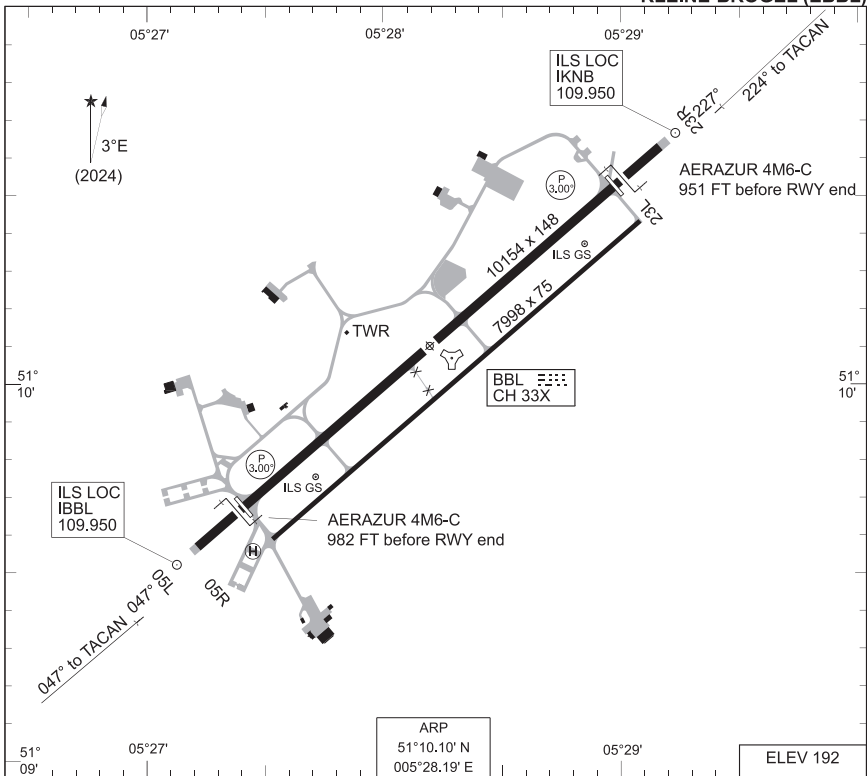

RWY	PCN	TORA	ASDA	TODA	LDA	PAPI	THR	TDZE	THR PSN
05L	114 F/A/X/T	8042	9048	9048	7926	3.00°	185	185	51°09.70' N - 005°27.41' E
23R	114 F/A/X/T	8106	9205	9205	7926	3.00°	161	171	51°10.53' N - 005°29.00' E
05R	76 F/A/X/T	6893	7854	7854	6893	-	190	190	51°09.61' N - 005°27.53' E
23L	76 F/A/X/T	6791	7854	7854	6791	-	161	162	51°10.43' N - 005°29.11' E

KLEINE-BROGEL APP	337.600	362.300	134.480	122.505	KLEINE-BROGEL TWR	248.075	257.800	134.105	121.500
KLEINE-BROGEL PAR	388.950	282.200	141.550	123.300	KLEINE-BROGEL GND	362.775	122.100		

	PROC. CRITERIA	RWY	GS	TCH	OTCH	RPI	CAT	MINIMA CRITERIA	MINIMA
PAR	MIPS	05L	3.00°	54	87	901	ABCD	MIPS	445 - 0.8 260 (300 - 0.8 / 1.2)
		23R	3.00°	54	87	1091	HPMA		385 - 0.8 200 (200 - 0.8 / 0.9)
		05R	3.00°	50	-	915	ABCD		429 - 0.8 268 (300 - 0.8 / 1.3)
		23L	3.00°	33	-	633	HPMA		366 - 0.8 205 (300 - 0.8 / 0.9)
									399 - 1.0 209 (300 - 1.0 / 1.0)
									388 - 1.2 227 (300 - 1.2 / 1.2)

CHANGE: Editorial

BEL DEFENCE / AIR COMPONENT 16-APR-2026 - THS

AERODROME CHART

KLEINE-BROGEL (EBBL)

MIPS
INSTRUMENT DEPARTURE CHART

HPMA BL 05A - 05B
KLEINE-BROGEL (EBBL)

AD ELEV 192

KLEINE-BROGEL GND 362.775 122.100		KLEINE-BROGEL TWR 248.075 134.105		KLEINE-BROGEL APP 337.600 134.480		BELGA RADAR 374.400 129.325				
TACAN BBL - CH 33X		RWY 05	PDG 8.75%	From-To DER-4500		120 1070	180 1600	240 2130	300 2660	Reason ATC

CAUTION:

- a) RADAR FLIGHT PATH MONITORING REQUIRED TO REMAIN WITHIN BEL
- b) NO TURN BEFORE 1.3 DME BBL
- c) FIRST TURN MAX 300 KIAS

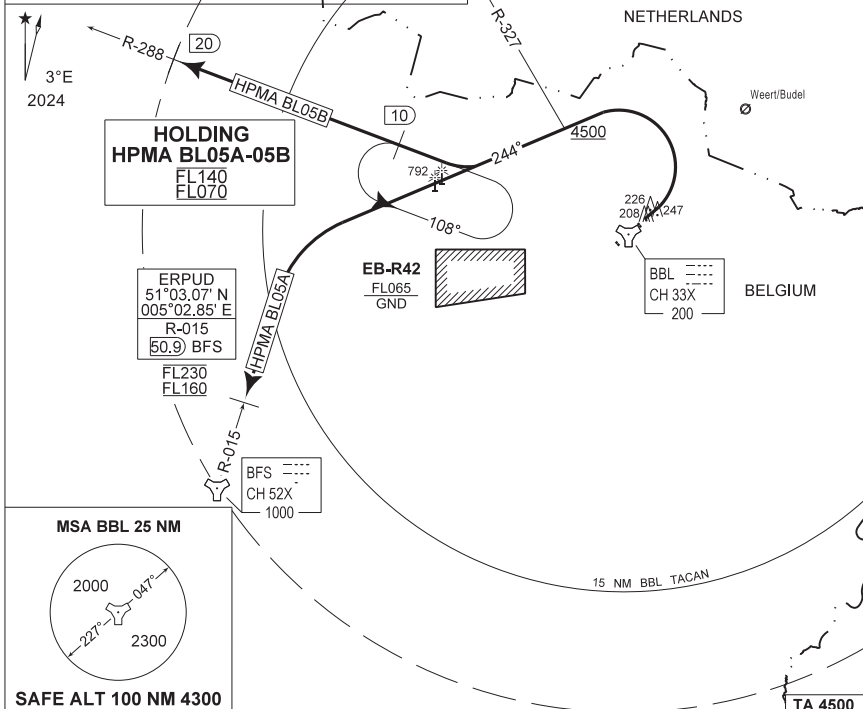

SAFE ALT 100 NM 4300

TA 4500

HPMA BL05A
(RWY 05)

29

- Climb RWY heading and contact EBBL APP.
- Pass 600 FT AMSL or 1.3 DME BBL, whichever comes the latest, turn left track 244° at MAX 300 KIAS.
- Pass R-327 at or above 4500 FT AMSL and contact BELGA RADAR.
- Intercept R-015 inbound BFS TACAN.
- Proceed to entry REMBA corridor ERPUD, 50.9 DME R-015 BFS TACAN between FL160 and FL230 as instructed and maintain level.

HPMA BL05B
(RWY 05)

28

- Climb RWY heading and contact EBBL APP.
- Pass 600 FT AMSL or 1.3 DME BBL, whichever comes the latest, turn left track 244° at MAX 300 KIAS.
- Pass R-327 at or above 4500 FT AMSL and contact BELGA RADAR.
- Intercept R-288 outbound BBL TACAN.
- Follow R-288 till 20 DME.

CHANGE: Editor/kl

BEL DEFENCE. AIR COMPONENT 16-APR-2026 - THIS

HPMA BL 05A - 05B

51°10,10' N
005°28,19' E

KLEINE-BROGEL (EBBL)

MIPS
INSTRUMENT DEPARTURE CHART

AD ELEV 192

HPMA BL 05E- 23E
KLEINE-BROGEL (EBBL)

KLEINE-BROGEL GND 362.775 122.100	KLEINE-BROGEL TWR 248.075 134.105		KLEINE-BROGEL APP 337.600 134.480		EFFLUX: TAD as assigned BELGA RADAR: 374.400					
TACAN BBL - CH 33X	RWY 05	PDG 10.51% 6.00°		From-To DER-TRL	120 1280	180 1920	240 2250	300 3190	360 3830	Reason ATC
CAUTION:	23	10.51%	6.00°	DER-TRL	1280	1920	2250	3190	3830	ATC

- a) CLIMB AT MNM 6° (10.51%) TO REACH FL100 BEFORE CROSSING BBL R-288 / 10 DME
- b) BL 05E: RADAR FLIGHT PATH MONITORING REQUIRED TO REMAIN WITHIN BEL
- c) BL 23E: RADAR FLIGHT PATH MONITORING REQUIRED TO REMAIN WITHIN BEL/TO REMAIN CLEAR OF EB-R42

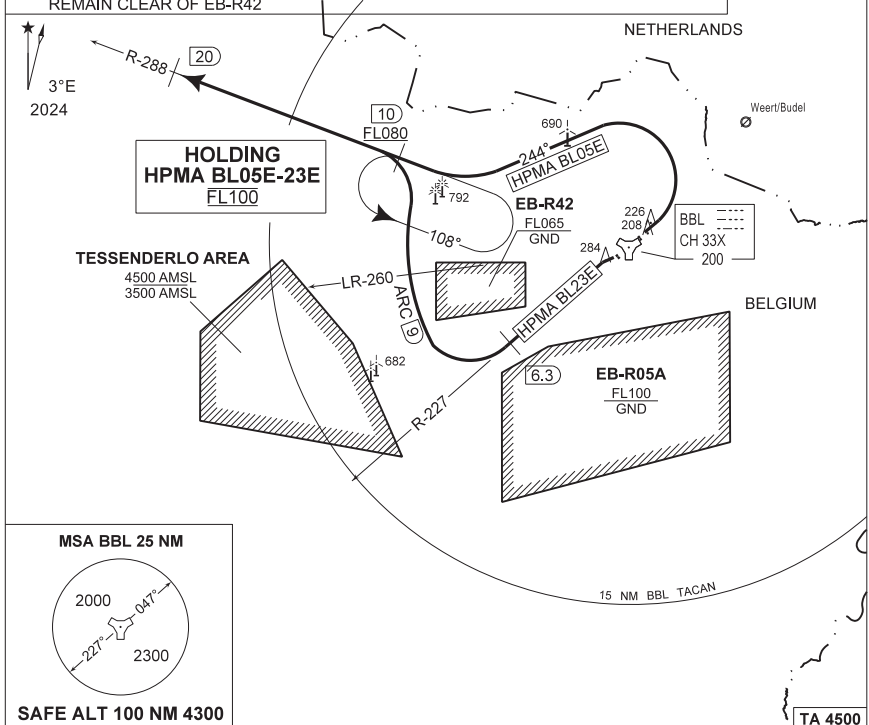

HPMA BL 05E (RWY 05) 28	<ul style="list-style-type: none"> - Climb RWY heading and contact EBBL APP. - Pass 600 FT AMSL or 1.3 DME BBL, whichever comes the latest, turn left track 244° at MAX 300 KIAS. - Intercept R-288 outbound BBL TACAN. - Pass 10 DME / R-288 at or above FL080. - Contact EFFLUX on the assigned TAD when passing FL100 or BELGA RADAR as instructed. - Follow R-288 till 20 DME (unless instructed otherwise).
HPMA BL 23E (RWY 23) 34	<ul style="list-style-type: none"> - Climb RWY heading and contact EBBL APP. - Intercept R-227 outbound BBL TACAN. - At 6.3 DME turn right to follow the arc at 9 DME BBL. - Passing R-260, turn left to intercept R-288 outbound BBL TAC. - Pass 10 DME / R-288 at or above FL080. - Contact EFFLUX on the assigned TAD when passing FL100 or BELGA RADAR as instructed. - Follow R-288 till 20 DME (unless instructed otherwise).

HPMA BL 05E- 23E

51°10,10' N
005°28,19' E

KLEINE-BROGEL (EBBL)

CHANGE: Editorial

BEL DEFENCE, AIR COMPONENT 16-APR-2028 - THS

INSTRUMENT DEPARTURE CHART

AD ELEV 192

KLEINE-BROGEL (EBBL)

KLEINE-BROGEL GND 362.775 122.100		KLEINE-BROGEL TWR 248.075 134.105		KLEINE-BROGEL APP 337.600 134.480		BELGA RADAR 374.400 129.325					
TACAN BBL - CH 33X		RWY 05	PDG 5.24%	3.00°	From-To DER-FL050	120 640	180 960	240 1280	300 1600	360 1920	Reason ATC

CAUTION:

- a) RADAR FLIGHT PATH MONITORING REQUIRED TO REMAIN WITHIN BEL
- b) NO TURN BEFORE 1.3 DME BBL
- c) FIRST TURN MAX 210 KIAS

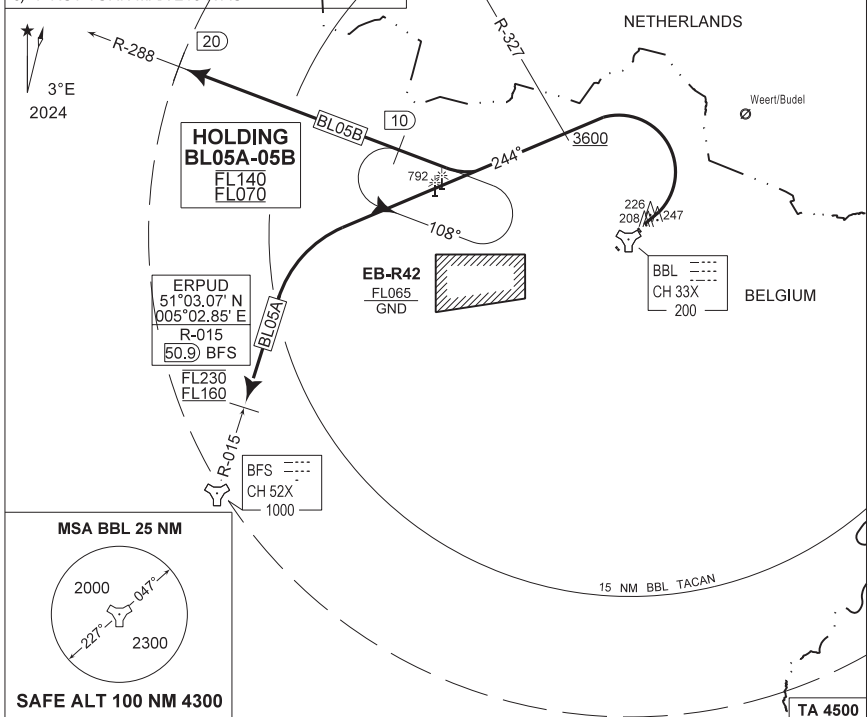

MSA BBL 25 NM

SAFE ALT 100 NM 4300

BL 05A (RWY 05) (29)

- Climb RWY heading and contact EBBL APP.
- Pass 600 FT AMSL or 1.3 DME BBL, whichever comes the latest, turn left track 244° at MAX 210 KIAS.
- Pass R-327 at or above 3600 FT AMSL.
- Passing 4500 FT AMSL contact BELGA RADAR.
- Intercept R-015 inbound BFS TACAN.
- Proceed to entry REMBA corridor ERPUD, 50.9 DME R-015 BFS TACAN between FL160 and FL230 as instructed and maintain level.

BL 05B (RWY 05) (28)

- Climb RWY heading and contact EBBL APP.
- Pass 600 FT AMSL or 1.3 DME BBL, whichever comes the latest, turn left track 244° at MAX 210 KIAS.
- Pass R-327 at or above 3600 FT AMSL.
- Passing 4500 FT AMSL contact BELGA RADAR.
- Intercept R-288 outbound BBL TACAN. Follow R-288 till 20 DME.

CHANGE Editorial

BEL DEFENCE, AIR COMPONENT 16-APR-2026 - THIS

MIPS
INSTRUMENT DEPARTURE CHART

HPMA BL 23A - 23B
KLEINE-BROGEL (EBBL)

AD ELEV 192

KLEINE-BROGEL GND 362.775 122.100	KLEINE-BROGEL TWR 248.075 134.105		KLEINE-BROGEL APP 337.600 134.480		BELGA RADAR 374.400 129.325	
TACAN BBL - CH 33X	RWY 23	PDG 8.75%	5.00°	From-To DER-10/R-289	120 1070	180 1600
					240 2130	300 2660
					360 3190	Reason ATC

CAUTION:

- a) PROCEDURE CANNOT BE EXECUTED IF EB-R42 IS RAISED ABOVE 2700 FT AMSL
- b) RADAR CONTROL MANDATORY ABOVE 4500 FT AMSL

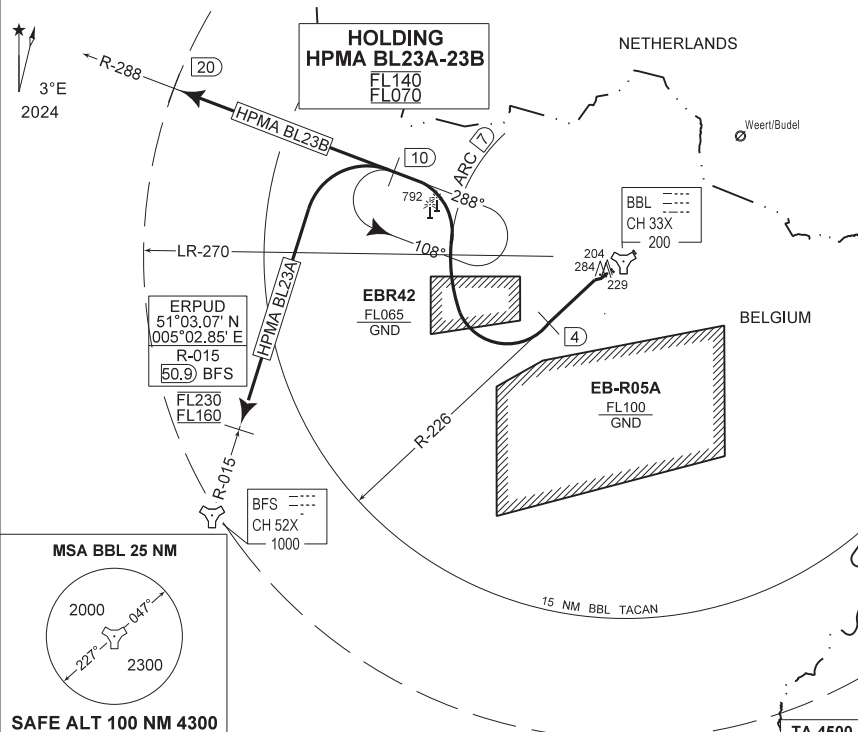

MSA BBL 25 NM



SAFE ALT 100 NM 4300

TA 4500

HPMA BL 23A
(RWY 23)

33

- Climb on R-226 outbound BBL TAC and contact EBBL APP.
- At 4 DME, turn right to follow the ARC at 7 DME BBL.
- Contact BELGA RADAR when passing 4500 FT AMSL.
- Passing R-270, turn left to intercept R-288 outbound BBL TACAN.
- At 10 DME BBL, turn left to intercept R-015 inbound BFS TACAN.
- Proceed to entry REMBA corridor ERPUD, 50.9 DME R-015 BFS TACAN between FL160 and FL230 as instructed and maintain level.

HPMA BL 23B
(RWY 23)

27

- Climb on R-226 outbound BBL TAC and contact EBBL APP.
- At 4 DME, turn right to follow the ARC at 7 DME BBL.
- Contact BELGA RADAR when passing 4500 FT AMSL.
- Passing R-270, turn left to intercept R-288 outbound BBL TACAN.
- Follow R-288 till 20 DME.

CHANGE: Editorial

BEL DEFENCE, AIR COMPONENT 16-APR-2026 - THIS

HPMA BL 23A - 23B

51°10,10' N
005°28,19' E

KLEINE-BROGEL (EBBL)

**MIPS
INSTRUMENT DEPARTURE CHART**

AD ELEV 192

**BL 23F
KLEINE-BROGEL (EBBL)**

KLEINE-BROGEL GND 362.775 122.100		KLEINE-BROGEL TWR 248.075 134.105		KLEINE-BROGEL APP 337.600 134.480		BELGA RADAR 374.400 129.325					
TACAN BBL - CH 33X		RWY 23	PDG 4.04%	2.31°	From-To DER-TRL	120 500	180 740	240 990	300 1230	360 1480	Reason ATC

CAUTION:

- a) IF TESSENDERLO AREA IS ACTIVE, PASS BBL R-240 AT MAX 3000 FT AMSL
- b) RADAR FLIGHT PATH MONITORING REQUIRED TO REMAIN CLEAR OF EB-R42

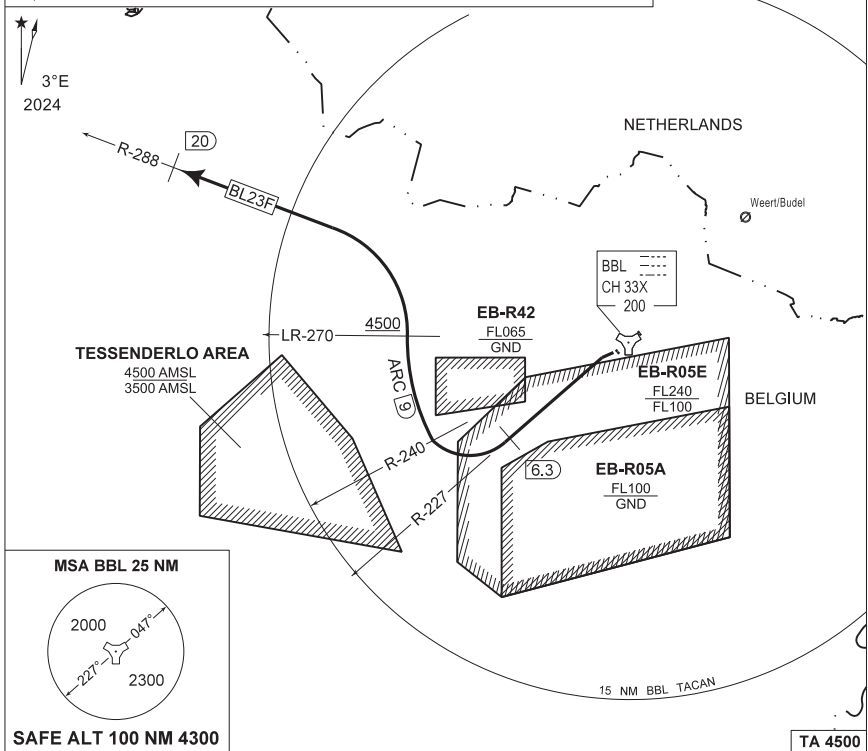

MSA BBL 25 NM



SAFE ALT 100 NM 4300

TA 4500

**BL 23F
(RWY 23)**

30

- Climb RWY heading and contact EBBL APP.
- Intercept R-227 outbound BBL TACAN.
- At 6.3 DME turn right to follow the arc at 9 DME BBL.
- Pass R-240 at or below 3000 FT AMSL if Tessenenderlo area active.
- Pass R-270 on the ARC at or above 4500 FT AMSL.
- Contact BELGA RADAR as instructed.
- Passing R-270, turn left to intercept R-288 outbound BBL TACAN then follow R-288 till 20 DME.

CHANGE: Editorial

BEL DEFENCE, AIR COMPONENT 16-APR-2026 - THS

BL 23F

51°10,10' N
005°28,19' E

KLEINE-BROGEL (EBBL)

**MIPS
INSTRUMENT DEPARTURE CHART**

**PAMPA
HELCHTEREN RANGE**

AD ELEV 192

PAMPA RANGE 389.575 251.075		KLEINE-BROGEL TWR 248.075 134.105		KLEINE-BROGEL APP 337.600 134.480		BELGA RADAR 374.400 129.325	
--------------------------------	--	--------------------------------------	--	--------------------------------------	--	--------------------------------	--

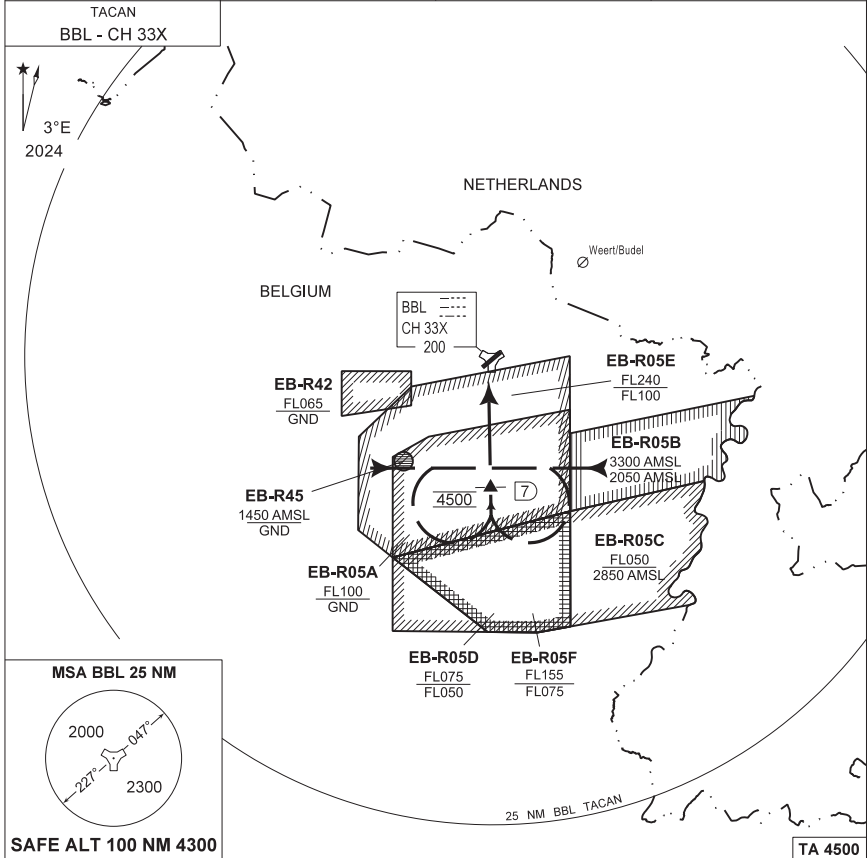

MSA BBL 25 NM

SAFE ALT 100 NM 4300

TA 4500

PAMPA

- When leaving PAMPA RANGE, perform a procedure turn to the south.
- Intercept R-177 inbound BBL TACAN.
- Pass 7 DME / R-177 at 4500 FT AMSL.
- Proceed with a Kleine-Brogel SID as cleared by ATC.

CHANGE: Editorial

BELDEFENCE: AIR COMPONENT 16-APR-2026 - THS

PAMPA

51°10,10' N
005°28,19' E

HELCHTEREN RANGE

**NATIONAL
CORRIDOR EBBL to TSA 24, 25 & 26**

**REMBA CORRIDOR SB OR NB
KLEINE-BROGEL (EBBL)**

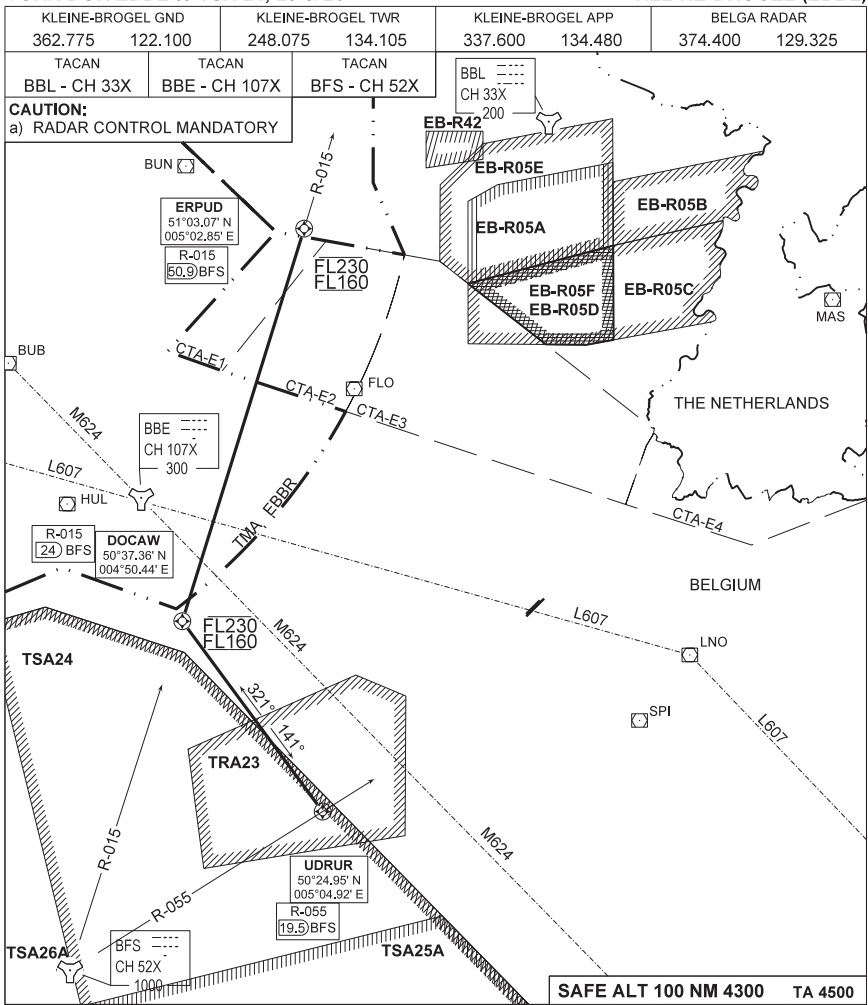

REMBA CORRIDOR SOUTHBOUND (SB)

- Proceed to ERPUD (50.9 DME / R-015 BFS).
- Pass ERPUD between FL160 and FL230 as instructed, fly inbound DOCAW.
- Passing DOCAW (24 DME / R-015 BFS) proceed as instructed.
- When proceeding to UDRUR (19.5 DME / R-055 BFS) turn left track 141°.

REMBA CORRIDOR NORTHBOUND (NB)

- Proceed to DOCAW (24 DME / R-015 BFS).
- Pass DOCAW between FL160 and FL230 as instructed, fly inbound ERPUD.
- Passing ERPUD (50.9 DME / R-015 BFS) proceed as instructed.

REMBA CORRIDOR SB OR NB

51°10,10' N
005°28,19' E

KLEINE-BROGEL (EBBL)

MIPS INSTRUMENT APPROACH CHART

**HPMA-ILS or HPMA-LOC RWY 05L
KLEINE-BROGEL (EBBL)**

AD ELEV 192

BELGA RADAR 374.400 129.325		KLEINE-BROGEL APP 337.600 134.480		KLEINE-BROGEL TWR 248.075 134.105		KLEINE-BROGEL GND 362.775 122.100	
LOC / DME KKNB 109.950 / 33X	APP COURSE 047°	GS INTCP ALT 1700 FT	GS 3.00°	DA 385	THR 185	ALS 930 M	LDA 7926 FT

CAUTION:

- a) RADAR FLIGHT PATH MONITORING REQUIRED TO REMAIN CLEAR OF EB-R42
- b) DECONFLICTION WITH EB-R05A REQUIRED WHEN PAMPA IS ACTIVE

NOTE:

- a) DME FREQUENCY 109.600 MHZ

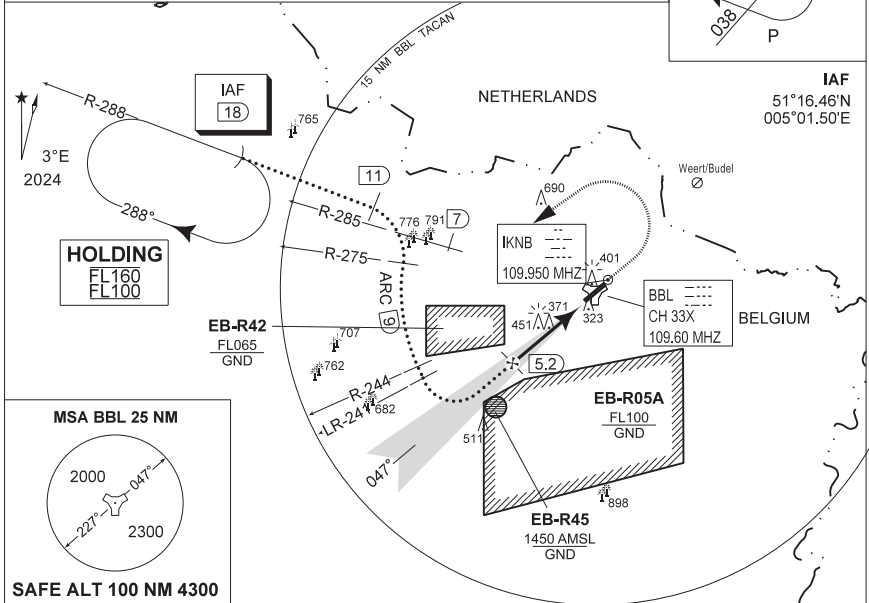
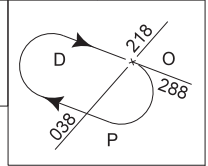

HOLDING
FL160
FL100

MSA BBL 25 NM

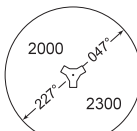

SAFE ALT 100 NM 4300

DME BBL	5	4	3	2
Altitude	1630	1310	990	670
Height	(1445)	(1125)	(815)	(485)

TA 4500

MISSED APPROACH

Climb straight ahead to 1000 FT. At 1 DME passed BBL TACAN continue climb to 3000 FT. At 2.5 DME passed BBL TACAN turn left at MAX 275 KIAS to Intercept 7 DME/R-285 outbound and proceed for a ILS z RWY 05L.

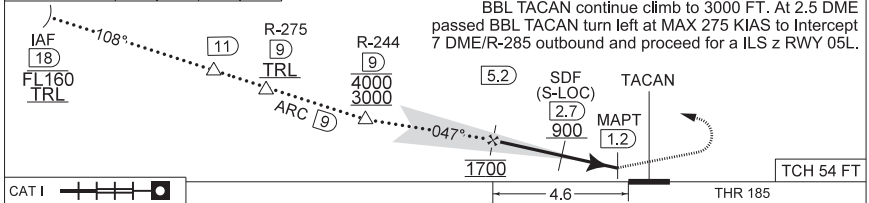

CAT I

HPMA	HPMA
CATEGORY	HPMA
S-ILS 05L	385 - 0.8 200 (200 - 0.8 / 0.9) GS 3.00°
S-PAR 05L	385 - 0.8 200 (200 - 0.8 / 0.9) GS 3.00°
S-LOC 05L	620 - 1.3 435 (500 - 1.3 / 2.3)

HPMA-ILS or HPMA-LOC RWY 05L

51°10.10' N
005°28.19' E

KLEINE-BROGEL (EBBL)

MIPS
INSTRUMENT APPROACH CHART

AD ELEV 192

ILS z or LOC z RWY 05L
KLEINE-BROGEL (EBBL)

BELGA RADAR 374.400 129.325		KLEINE-BROGEL APP 337.600 134.480		KLEINE-BROGEL TWR 248.075 134.105		KLEINE-BROGEL GND 362.775 122.100	
LOC / DME IKNB 109.950 / 33X		APP COURSE 047°		GS INTCP ALT 1700 FT		GS 3.00°	
		DA 385		THR 185 FT		ALS 930 M	
						LDA 7926 FT	

CAUTION:

- a) RADAR FLIGHT PATH MONITORING REQUIRED TO REMAIN CLEAR OF EB-R42
- b) DECONFLICTION WITH EB-R05A REQUIRED WHEN PAMPA IS ACTIVE

NOTE:

- a) DME FREQUENCY 109.600 MHZ

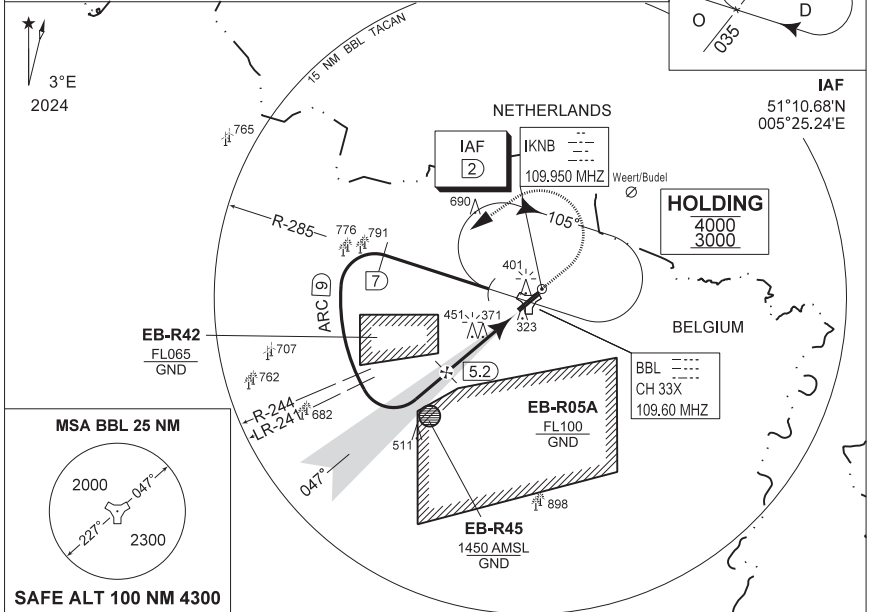
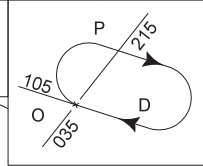

DME BBL	5	4	3	2
Altitude	1630	1310	990	670
Height	(1145)	(1125)	(805)	(485)

MISSED APPROACH
Climb straight ahead to 1000 FT. At 1 DME passed BBL TACAN continue climb to 3000 FT. At 2.5 DME passed BBL TACAN turn left at MAX 210 KIAS (MAX 275 KIAS for HPMA) to Intercept 7 DME/R-285 outbound and proceed for a ILS z RWY 05L.

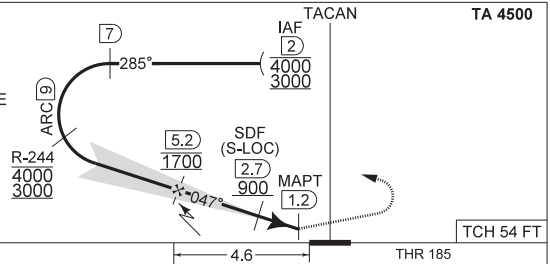

CATEGORY	A - B - C - D	HPMA
S-ILS 05L	385 - 0.8 200 (200 - 0.8 / 0.9) GS 3.00°	
S-PAR 05L	445 - 0.8 260 (300 - 0.8 / 1.2) GS 3.00°	385 - 0.8 200 (200 - 0.8 / 0.9) GS 3.00°
S-LOC 05L	620 - 1.3 435 (500 - 1.3 / 2.3)	

ILS z or LOC z RWY 05L

51°10.10' N
005°28.19' E

KLEINE-BROGEL (EBBL)

CHANGE: Editorial

BEL DEFENCE. AIR COMPONENT 16-APR-2026 - THIS

MIPS
INSTRUMENT APPROACH CHART

AD ELEV 192

ILS y or LOC y RWY 05L
KLEINE-BROGEL (EBBL)

BELGA RADAR 374.400 129.325		KLEINE-BROGEL APP 337.600 134.480		KLEINE-BROGEL TWR 248.075 134.105		KLEINE-BROGEL GND 362.775 122.100	
LOC / DME IKNB 109.950 / 33X	APP COURSE 047°	GS INTCP ALT 1700 FT	GS 3.00°	DA 385	THR 185 FT	ALS 930 M	LDA 7926 FT

CAUTION:

- a) PROCEDURE CANNOT BE EXECUTED WHEN EB-R05A IS ACTIVE
- b) RADAR FLIGHT PATH MONITORING REQUIRED TO REMAIN CLEAR OF EB-R42

NOTE:

- a) DME FREQUENCY 109.600 MHZ

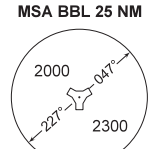
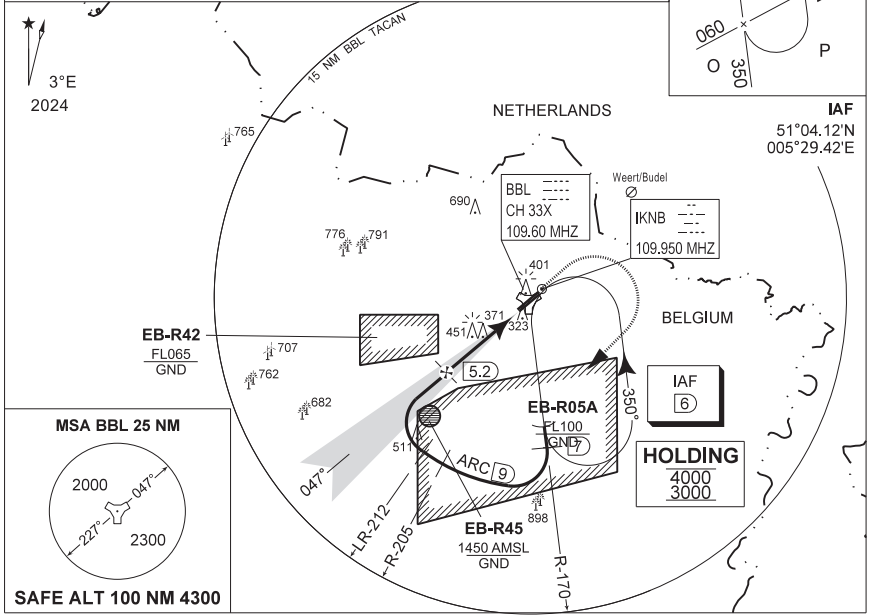
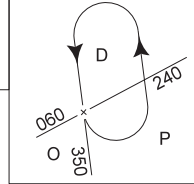

SAFE ALT 100 NM 4300

DME BBL	5	4	3	2
Altitude	1630	1310	990	670
Height	(1445)	(1125)	(805)	(485)

MISSED APPROACH
Climb straight ahead to 1000 FT. At 1 DME passed BBL TACAN continue climb to 3000 FT. At 2.5 DME passed BBL TACAN turn right at MAX 210 KIAS (MAX 275 KIAS for HPMA) to Intercept 6 DME/R-170 outbound and proceed for a ILS y RWY 05L.

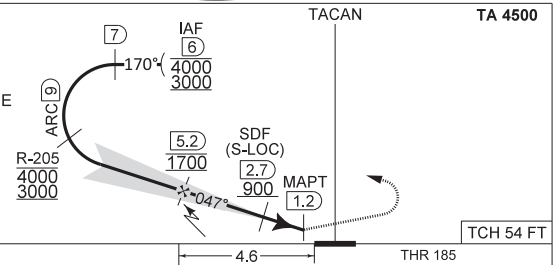

CAT I	4.6	THR 185	TCH 54 FT
-------	-----	---------	-----------

CATEGORY	A - B - C - D	HPMA
S-ILS 05L	385 - 0.8 200 (200 - 0.8 / 0.9) GS 3.00°	
S-PAR 05L	445 - 0.8 260 (300 - 0.8 / 1.2) GS 3.00°	385 - 0.8 200 (200 - 0.8 / 0.9) GS 3.00°
S-LOC 05L	620 - 1.3 435 (500 - 1.3 / 2.3)	

ILS y or LOC y RWY 05L

51°10.10' N
005°28.19' E

KLEINE-BROGEL (EBBL)

MIPS INSTRUMENT APPROACH CHART

HPMA-TACAN RWY 05L KLEINE-BROGEL (EBBL)

AD ELEV 192

BELGA RADAR 374.400 129.325		KLEINE-BROGEL APP 337.600 134.480		KLEINE-BROGEL TWR 248.075 134.105		KLEINE-BROGEL GND 362.775 122.100	
LOC / DME BBL CH 33X	APP COURSE 047°	FAF ALT 1700 FT	DESCENT GR 5.24%(3.00°)	MDA 620	THR 185 FT	ALS 930 M	LDA 7926 FT

CAUTION:

- a) RADAR FLIGHT PATH MONITORING REQUIRED TO REMAIN CLEAR OF EB-R42
- b) DECONFLICTION WITH EB-R05A REQUIRED WHEN PAMPA IS ACTIVE

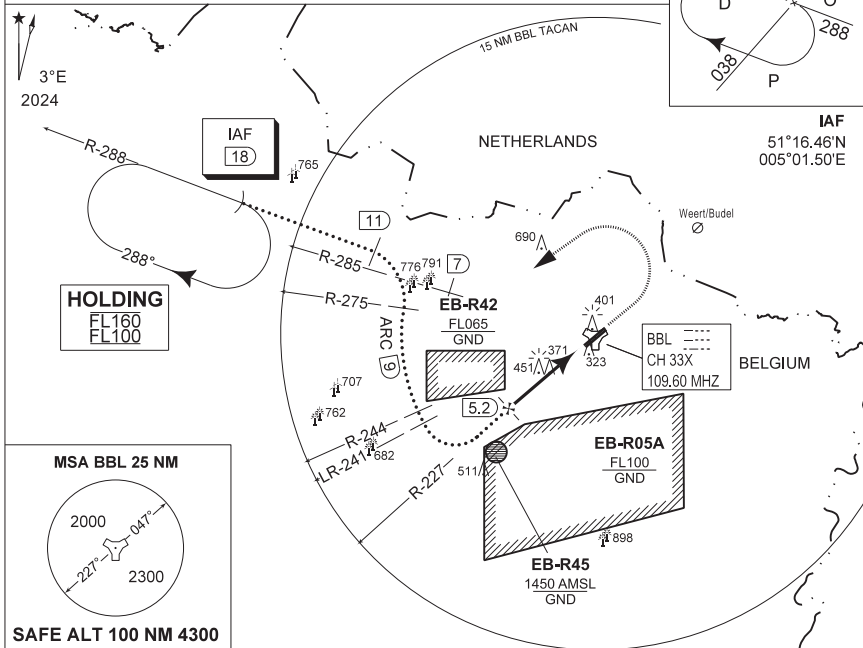
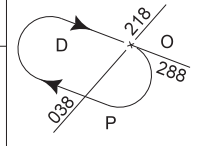

IAF
51°16.46'N
005°01.50'E

HOLDING
FL160
FL100

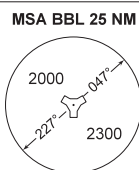

SAFE ALT 100 NM 4300

DME BBL	5	4	3	2
Altitude	1630	1310	990	670
Height	(1445)	(1125)	(805)	485

TA 4500 MISSED APPROACH

Climb straight ahead to 1000 FT. At 1 DME passed BBL TACAN continue climb to 3000 FT. At 2.5 DME passed BBL TACAN turn left at MAX 275 KIAS to intercept DME/R-285 outbound and proceed for a TACAN z RWY 05L.

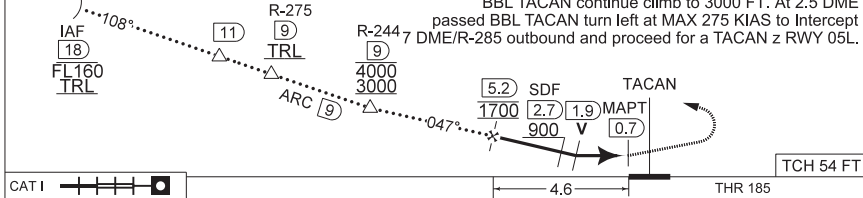

CATI [] THR 185

CATEGORY	HPMA
S-TAC 05L	620 - 1.3 435 (500 - 1.3 / 2.3)
S-PAR 05L	385 - 0.8 200 (200 - 0.8 / 0.9) GS 3.00°
CIRCLING	770 - 3.2 578 (600 - 3.2)

HPMA-TACAN RWY 05L

51°10.10' N
005°28.19' E

KLEINE-BROGEL (EBBL)

CHANGE: Editorial

BEL DEFENCE. AIR COMPONENT 16-APR-2026 - THIS

MIPS

INSTRUMENT APPROACH CHART

AD ELEV 192

**TACAN z RWY 05L
KLEINE-BROGEL (EBBL)**

BELGA RADAR 374.400 129.325		KLEINE-BROGEL APP 337.600 134.480		KLEINE-BROGEL TWR 248.075 134.105		KLEINE-BROGEL GND 362.775 122.100	
LOC / DME BBL CH 33X	APP COURSE 047°	FAF ALT 1700 FT	DESCENT GR 5.24% (3.00°)	MDA 620	THR 185 FT	ALS 930 M	LDA 7926 FT

CAUTION:

- a) RADAR FLIGHT PATH MONITORING REQUIRED TO REMAIN CLEAR OF EB-R42
- b) DECONFLICTION WITH EB-R05A REQUIRED WHEN PAMPA IS ACTIVE

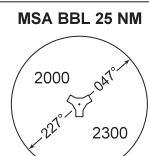
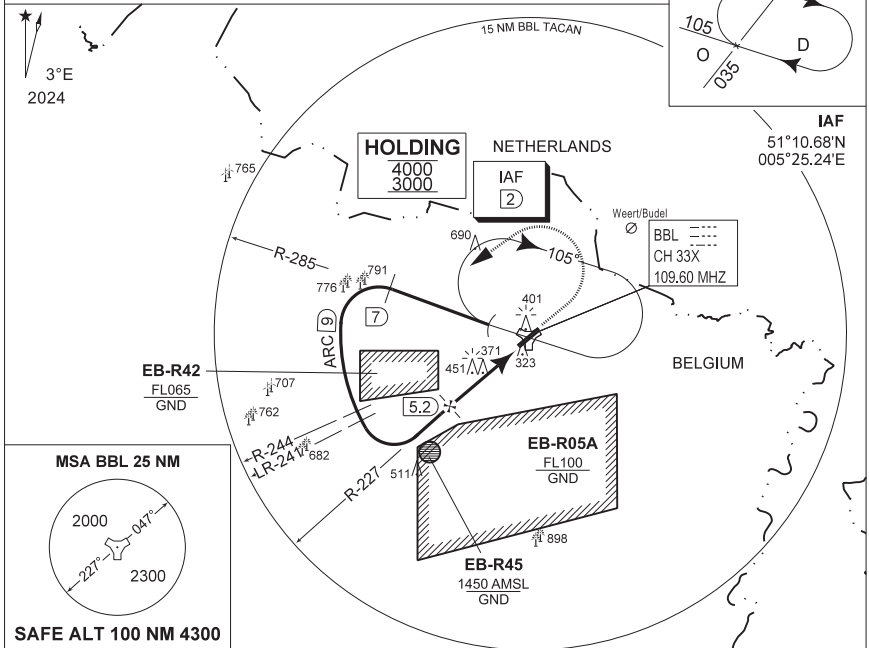
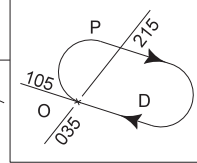

SAFE ALT 100 NM 4300

DME BBL	5	4	3	2	TA 4500
Altitude Height	1630 (1445)	1310 (1125)	990 (805)	670 (485)	

MISSED APPROACH

Climb straight ahead to 1000 FT. At 1 DME passed BBL TACAN continue climb to 3000 FT. At 2.5 DME passed BBL TACAN turn left at MAX 210 KIAS (MAX 275 KIAS for HPM) to Intercept 7 DME/R-285 outbound and proceed for a TACAN z RWY 05L.

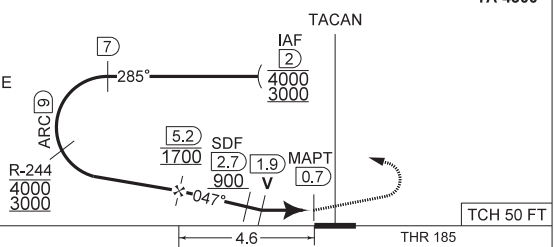

CAT I	4.6	THR 185	TCH 50 FT
-------	-----	---------	-----------

CATEGORY	A - B	C	D	HPMA
S-TAC 05L	620 - 1.3 435 (500 - 1.3 / 2.3)			
S-PAR 05L	445 - 0.8 260 (300 - 0.8 / 1.2) GS 3.00°	385 - 0.8 200 (200 - 0.8 / 0.9) GS 3.00°		
CIRCLING	750 - 1.6 558 (600 - 1.6)	890 - 2.4 698 (700 - 2.4)	1090 - 3.6 898 (900 - 3.6)	770 - 3.2 578 (600 - 3.2)

TACAN z RWY 05L

51°10.10' N
005°28.19' E

KLEINE-BROGEL (EBBL)

CHANGE: Editorial

BEL DEFENCE, AIR COMPONENT 16-APR-2026 - THS

MIPS
INSTRUMENT APPROACH CHART

AD ELEV 192

TACAN y RWY 05L
KLEINE-BROGEL (EBBL)

BELGA RADAR		KLEINE-BROGEL APP		KLEINE-BROGEL TWR		KLEINE-BROGEL GND	
374.400	129.325	337.600	134.480	248.075	134.105	362.775	122.100
LOC / DME	APP COURSE	FAF ALT	DESCENT GR	MDA	THR	ALS	LDA
BBL CH 33X	047°	1700 FT	5.24% (3.00°)	620	185 FT	930 M	7926 FT

CAUTION:

- a) PROCEDURE CANNOT BE EXECUTED WHEN EB-R05A IS ACTIVE
- b) RADAR FLIGHT PATH MONITORING REQUIRED TO REMAIN CLEAR OF EB-R42

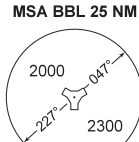
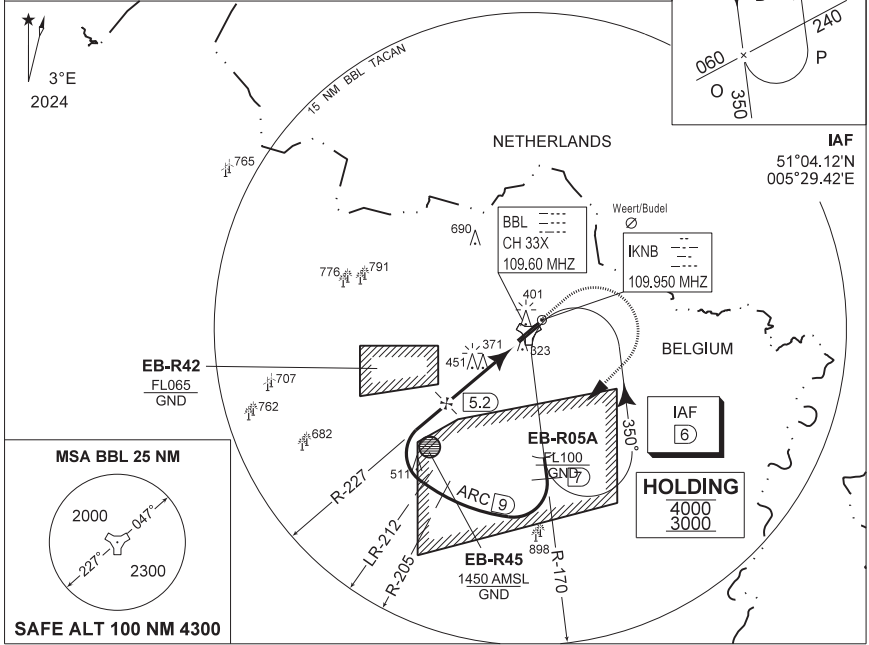
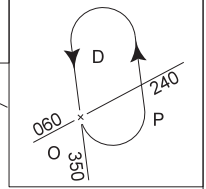

SAFE ALT 100 NM 4300

DME BBL	5	4	3	2
Altitude	1630	1310	990	670
Height	(1445)	(1125)	(805)	(485)

MISSED APPROACH
 Climb straight ahead to 1000 FT. At 1 DME passed BBL TACAN continue climb to 3000 FT. At 2.5 DME passed BBL TACAN turn right at MAX 210 KIAS (MAX 275 KIAS for HPMA) to Intercept 6 DME/R-170 outbound and proceed for a TACAN y RWY 05L.

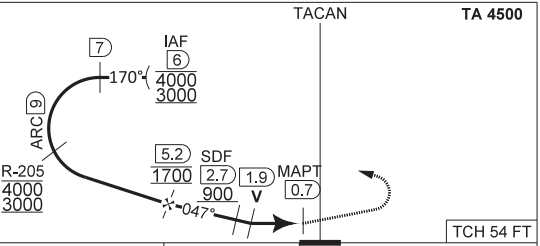

CATEGORY	A - B	C	D	HPMA
S-TAC 05L	620 - 1.3 435 (500 - 1.3 / 2.3)			
S-PAR 05L	445 - 0.8 260 (300 - 0.8 / 1.2) GS 3.00°	385 - 0.8 200 (200 - 0.8 / 0.9) GS 3.00°		
CIRCLING	750 - 1.6 558 (600 - 1.6)	890 - 2.4 698 (700 - 2.4)	1090 - 3.6 898 (900 - 3.6)	770 - 3.2 578 (600 - 3.2)

TACAN y RWY 05L

51°10.10' N
 005°28.19' E

KLEINE-BROGEL (EBBL)

CHANGE: Editorial

BEL DEFENCE: AIR COMPONENT 16-APR-2028 - THS

MIPS
INSTRUMENT APPROACH CHART

HPMA-ILS or HPMA-LOC RWY 23R
KLEINE-BROGEL (EBBL)

AD ELEV 192

BELGA RADAR 374.400 129.325		KLEINE-BROGEL APP 337.600 134.480		KLEINE-BROGEL TWR 248.075 134.105		KLEINE-BROGEL GND 362.775 122.100	
LOC / DME IBBL 109.950 / 33X	APP COURSE 227°	GS INTCP ALT 1700 FT	GS 3.00°	DA 361	THR 161 FT	ALS 930 m	LDA 7926 FT

CAUTION:
a) CLASS E AIRSPACE IN AMSTERDAM FIR
b) AIRCRAFT PROCEEDING IAF AT FL100 OR ABOVE REQUIRES DECONFLICTION WITH EB-R05E

NOTE:
a) DME FREQUENCY 109.600 MHZ

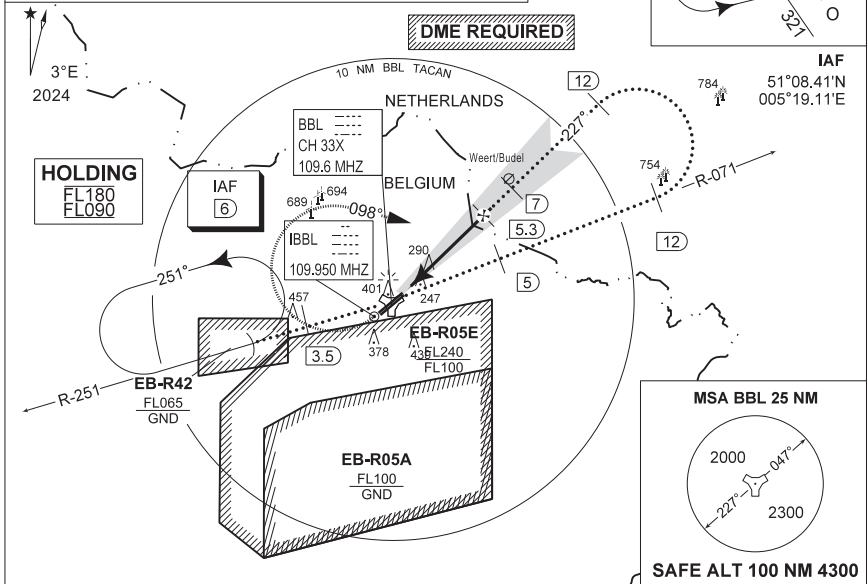
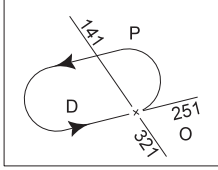

DME BBL	5	4	3	2
Altitude	1600	1290	970	650
Height	(1439)	(1129)	(809)	(489)

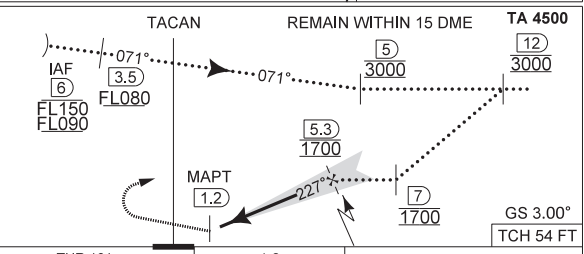

MISSED APPROACH
Climb straight ahead to 1000 FT. Passing 1 DME BBL TACAN turn right track 098° at MAX 210 KIAS (MAX 275 KIAS for HPMA) and continue the climb to 3000 FT. Intercept R-071 outbound. If no radio contact, proceed for a ILS RWY 23R at 3000 FT.

CAT I	<input checked="" type="checkbox"/>	THR 161	4.6	GS 3.00°	TCH 54 FT
-------	-------------------------------------	---------	-----	----------	-----------

CATEGORY	HPMA	
S-ILS 23R	361	- 0.8 200 (200 - 0.8 / 0.9) GS 3.00°
S-PAR 23R	366	- 0.8 205 (300 - 0.8 / 0.9) GS 3.0°
S-LOC 23R	540	- 1.0 379 (400 - 1.0 / 1.9)

HPMA-ILS or HPMA-LOC RWY 23R 51°10.10' N
005°28.19' E **KLEINE-BROGEL (EBBL)**

CHANGE: Editorial

BEL DEFENCE. AIR COMPONENT 16-APR-2026 - THIS

MIPS
INSTRUMENT APPROACH CHART

ILS or LOC RWY 23R
KLEINE-BROGEL (EBBL)

AD ELEV 192

BELGA RADAR 374.400 129.325		KLEINE-BROGEL APP 337.600 134.480		KLEINE-BROGEL TWR 248.075 134.105		KLEINE-BROGEL GND 362.775 122.100	
LOC / DME IBBL 109.950 / 33X	APP COURSE 227°	GS INTCP ALT 1700 FT	GS 3.00°	DA 361	THR 161 FT	ALS 930 M	LDA 7926 FT

CAUTION:

a) CLASS E AIRSPACE IN AMSTERDAM FIR

WARNING:

a) MISSED APPROACH CLIMB GRADIENT OF MNM 3.2% IN THE STRAIGHT SEGMENT DUE TO OBSTACLES

NOTE:

a) DME FREQUENCY 109.600 MHZ

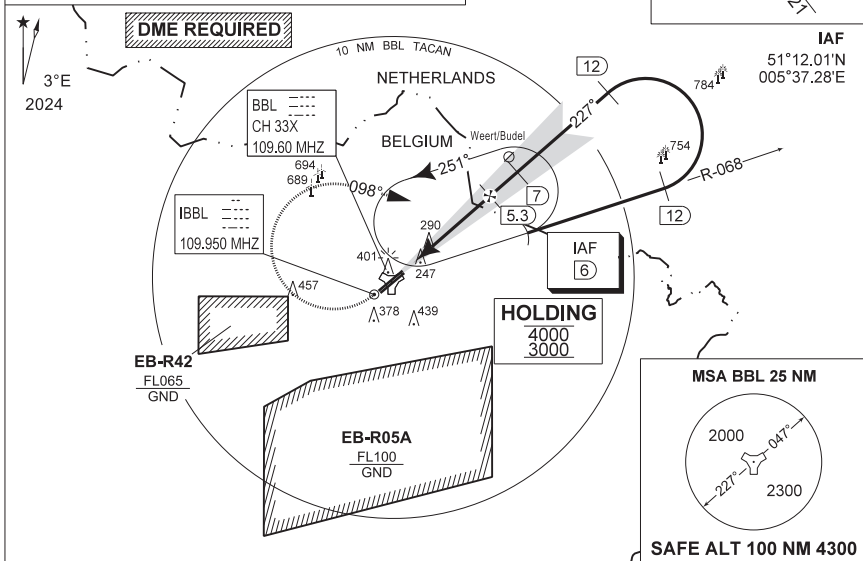
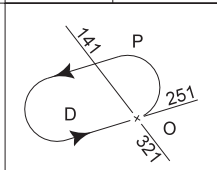

DME BBL	5	4	3	2
Altitude	1600	1290	970	650
Height	(1439)	(1129)	(809)	(489)

MISSED APPROACH

Climb straight ahead to 1000 FT. Passing 1 DME outbound BBL TACAN turn right track 098° at MAX 210 KIAS (MAX 275 KIAS for HPMA) and continue the climb to 3000 FT. Intercept R-068 outbound. If no radio contact, proceed for a ILS RWY 23R at 3000 FT.

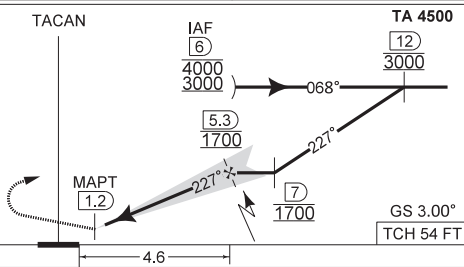

CATI	THR 161	4.6	GS 3.00°	TCH 54 FT
------	---------	-----	----------	-----------

CATEGORY	A - B - C - D	HPMA
S-ILS 23R	361 - 0.8 200 (200 - 0.8 / 0.9) GS 3.00°	
S-PAR 23R	429 - 0.8 268 (300 - 0.8 / 1.3) GS 3.00°	366 - 0.8 205 (300 - 0.8 / 0.9) GS 3.00°
S-LOC 23R	540 - 1.0 379 (400 - 1.0 / 1.9)	

ILS or LOC RWY 23R

51°10.1' N
005°28.19' E

KLEINE-BROGEL (EBBL)

CHANGE: Editorial

BEL DEFENCE. AIR COMPONENT 16-APR-2026 - THIS

MIPS INSTRUMENT APPROACH CHART

HPMA-TACAN RWY 23R KLEINE-BROGEL (EBBL)

AD ELEV 192

BELGA RADAR 374.400 129.325		KLEINE-BROGEL APP 337.600 134.480		KLEINE-BROGEL TWR 248.075 134.105		KLEINE-BROGEL GND 362.775 122.100	
TACAN BBL CH 33X	APP COURSE 224°	FAF ALT 1700 FT	DESCENT GR 5.24%(3.00°)	MDA 620	THR 161 FT	ALS 930 M	LDA 7926 FT

CAUTION:

- a) CLASS E AIRSPACE IN AMSTERDAM FIR
- b) AIRCRAFT PROCEEDING IAF AT FL100 OR ABOVE REQUIRES DECONFLICTION WITH EB-R05E

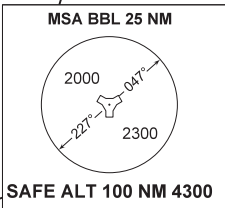
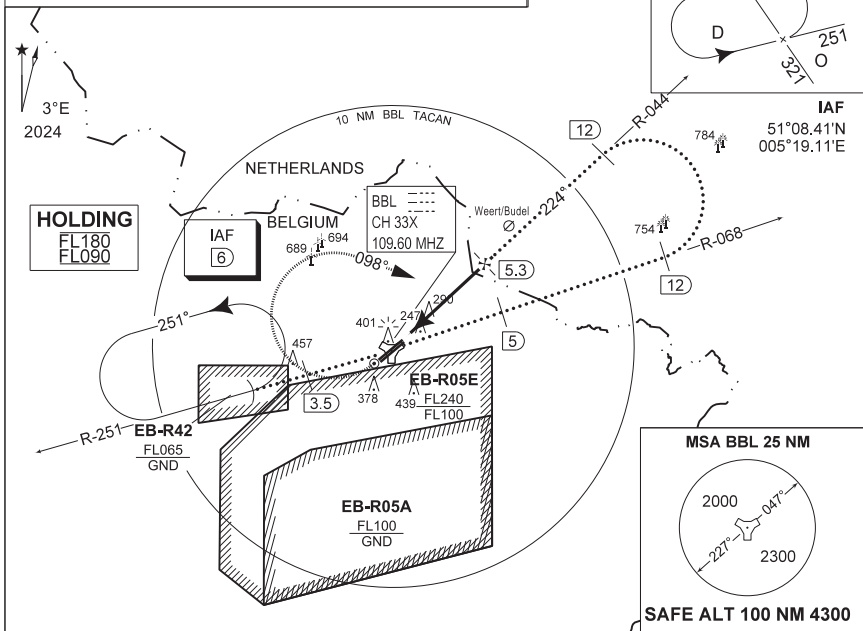
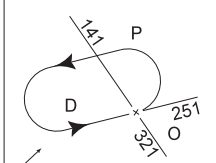

DME BBL	5	4	3	2
Altitude	1600	1290	970	650
Height	(1439)	(1129)	(809)	(489)

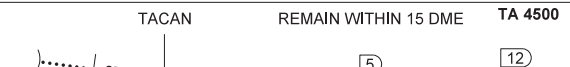

MISSED APPROACH
Climb straight ahead to 1000 FT. Passing 1 DME BBL TACAN turn right track 098° at MAX 275 KIAS and continue the climb to 3000 FT. Intercept R-068 outbound. If no radio contact, proceed for a TACAN or ILS RWY 23R at 3000 FT.

CAT I	THR 161	4.6	TCH 54 FT
-------	---------	-----	-----------

CATEGORY	HPMA
S-TAC 23R	620 - 1.5 459 (500 - 1.5 / 2.4)
S-PAR 23R	366 - 0.8 205 (300 - 0.8 / 0.9) GS 3.00°
CIRCLING	770 - 3.2 578 (600 - 3.2)

HPMA-TACAN RWY 23R

51°10.10' N
005°28.19' E

KLEINE-BROGEL (EBBL)

CHANGE: Editorial

BEL DEFENCE. AIR COMPONENT 16-APR-2026 - THIS

MIPS
INSTRUMENT APPROACH CHART

TACAN RWY 23R
KLEINE-BROGEL (EBBL)

AD ELEV 192

BELGA RADAR 374.400 129.325		KLEINE-BROGEL APP 337.600 134.480		KLEINE-BROGEL TWR 248.075 134.105		KLEINE-BROGEL GND 362.775 122.100	
TACAN BBL CH 33X	APP COURSE 224°	FAF ALT 1700 FT	DESCENT GR 5.24%(3.00°)	MDA 620	THR 161 FT	ALS 930 M	LDA 7926 FT

CAUTION:

a) CLASS E AIRSPACE IN AMSTERDAM FIR

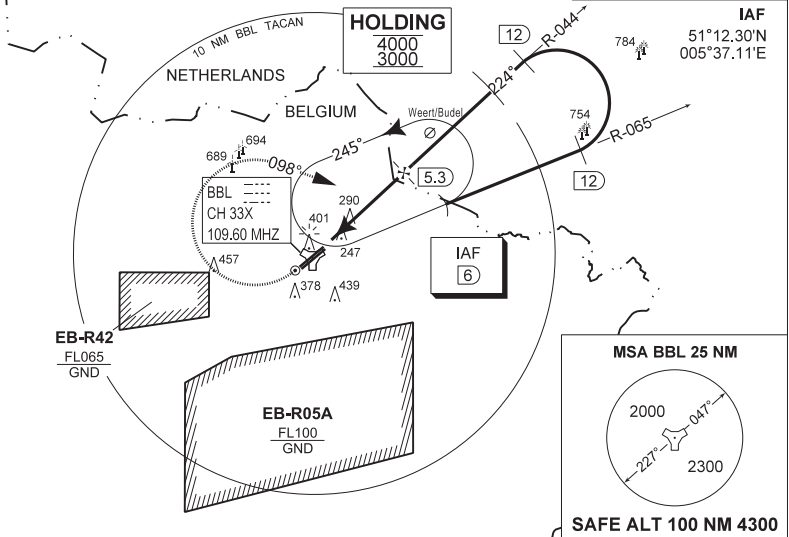
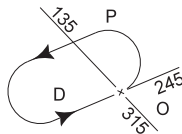

DME BBL	5	4	3	2
Altitude	1600	1290	970	650
Height	(1439)	(1129)	(809)	(489)

TACAN

REMAIN WITHIN 15 DME

TA 4500

MISSED APPROACH

Climb straight ahead to 1000 FT. Passing 1 DME BBL TACAN turn right track 098° at MAX 210 KIAS (MAX 275 KIAS for HPMA) and continue the climb to 3000 FT. Intercept R-065 outbound. If no radio contact, proceed for a TACAN RWY 23R at 3000 FT.

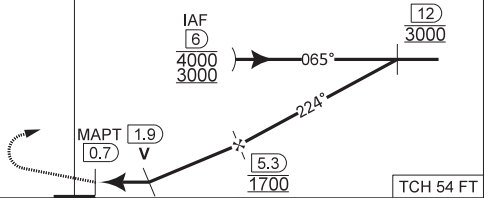

THR 161

CATEGORY	A - B	C	D	HPMA
S-TAC 23R	620 - 1.5 459 (500 - 1.5 / 2.4)			
S-PAR 23R	429 - 0.8 268 (300 - 0.8 / 1.3) GS 3.00°			366 - 0.8 205 (300 - 0.8 / 0.9) GS 3.00°
CIRCLING	750 - 1.6 558 (600 - 1.6)	890 - 2.4 698 (700 - 2.4)	1090 - 3.6 898 (900 - 3.6)	770 - 3.2 578 (600 - 3.2)

TACAN RWY 23R

51°10.10' N
005°28.19' E

KLEINE-BROGEL (EBBL)

AERODROME CHART

KOKSIJDE (EBFN)

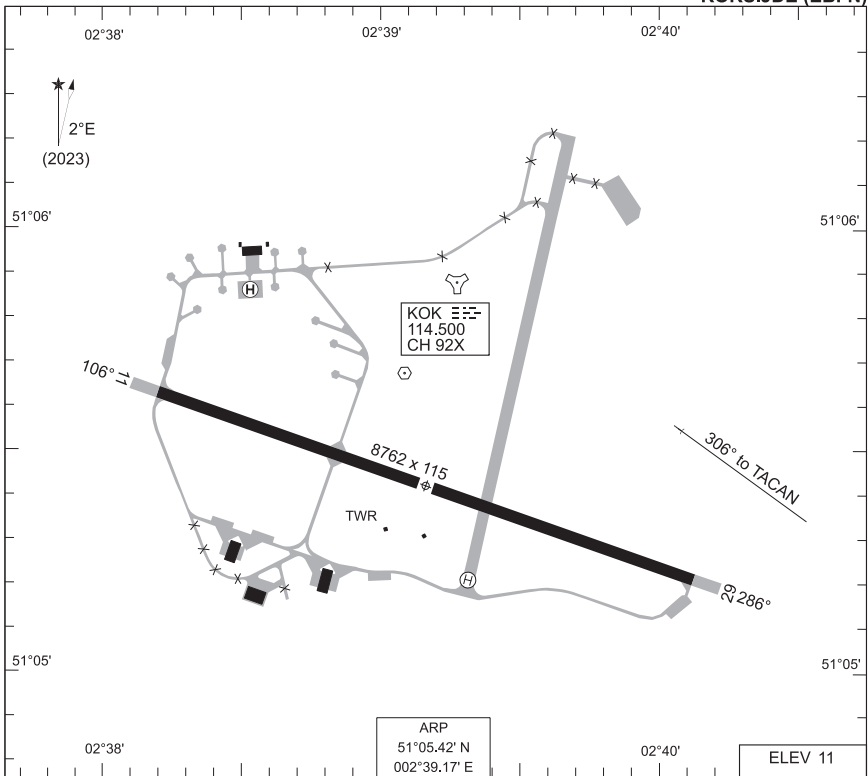

ARP
51°05.42' N
002°39.17' E

ELEV 11

RWY	PCN	TORA	ASDA	TODA	LDA	PAPI	THR	TDZE	THR PSN
11	22 F/C/W/T	8762	8762	8762	8436	NA	6	7	51°05.62' N - 002°38.16' E
29	22 F/C/W/T	8762	8762	8762	8446	NA	11	11	51°05.20' N - 002°40.18' E

KOKSIJDE APP	235.050	362.300	121.055	122.505	KOKSIJDE TWR	231.800	257.800	122.100
KOKSIJDE PAR	278.675	123.300			KOKSIJDE GND	122.100	231.800	

PAR	PROC. CRITERIA	RWY	GS	TCH	OTCH	RPI	CAT	MINIMA CRITERIA	MINIMA
	MIPS	29	3.00°	22		1108	ABCD	MIPS	211 - 0.8 200 (200 - 0.8 / 1.0)
	MIPS	29	3.00°	22		1108	HPMA	MIPS	211 - 0.8 200 (200 - 0.8 / 1.0)
	MIPS	29	3.00°	22		1108	H	MIPS	162 - 0.4 151 (200 - 0.4 / 0.8)

CHANGES: TWY A2, N3 and N4 cannot be used as taxiways

BELDEFENCE / AIR COMPONENT 19-MAR-2025 - THS

AERODROME CHART

KOKSIJDE (EBFN)

MIPS
INSTRUMENT DEPARTURE CHART

AD ELEV 11

FN 11 - 29
KOKSIJDE (EBFN)

KOKSIJDE GND		KOKSIJDE TWR		KOKSIJDE APP			BELGA RADAR				
231.800	122.100	231.800	122.100	235.050	121.055		374.400	129.325			
DVORTAC		RWY	PDG	From-To	120	180	240	300	360	Reason	
KOK 114.500 CH 92X		11	4.48%	2.57°	DER-4500	550	820	1090	1370	1640	ATC
CAUTION:		29	3.30%	1.89°	DER-4500	410	610	810	1010	1210	ATC

a) FIRST TURN MAX 200 KIAS
(300 KIAS FOR HPMA)

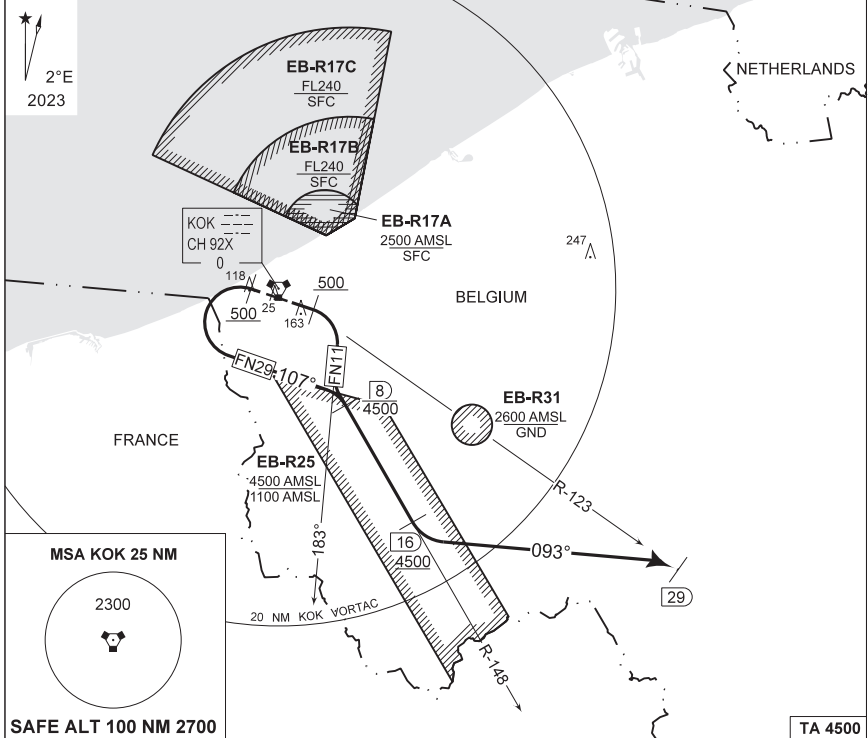

FN 11
(RWY 11)

30

- Climb straight ahead.
- When passing 500 FT AMSL turn right, track 183° to intercept R-148 outbound KOK VORTAC.
- Remain below 4500 FT until passing 8 DME on R-148 outbound KOK.
- Contact BELGA RADAR, when passing 4500 FT.
- At 16 DME, at or above 4500 FT turn left track 093°.
- Intercept R-123 outbound KOK.

FN 29
(RWY 29)

38

- Climb straight ahead.
- When passing 500 FT AMSL turn left, track 107° to intercept R-148 outbound KOK VORTAC.
- Remain below 4500 FT until passing 8 DME on R-148 outbound KOK.
- Contact BELGA RADAR, when passing 4500 FT.
- At 16 DME, at or above 4500 FT turn left track 093°.
- Intercept R-123 outbound KOK.

CHANGE: Editorial

FN 11 - 29

51°05.42' N
002°39.17' E

KOKSIJDE (EBFN)

BEL DEFENCE. AIR COMPONENT 16-APR-2026 - THIS

**MIPS
INSTRUMENT DEPARTURE CHART**

AD ELEV 11

**FN 11 COPTER - 29 COPTER
KOKSIJDE (EBFN)**

KOKSIJDE GND 231.800 122.100		KOKSIJDE TWR 231.800 122.100		KOKSIJDE APP 235.050 121.055			BELGA RADAR 374.400 129.325				
DVORTAC KOK 114.500 CH 92X		RWY 11	PDG 5.00%	2.86°	From-To DER-2200	60 310	120 610	180 920	240 N/A	300 N/A	Reason ATC
		29	5.00%	2.86°	DER-2200	310	610	920	N/A	N/A	ATC

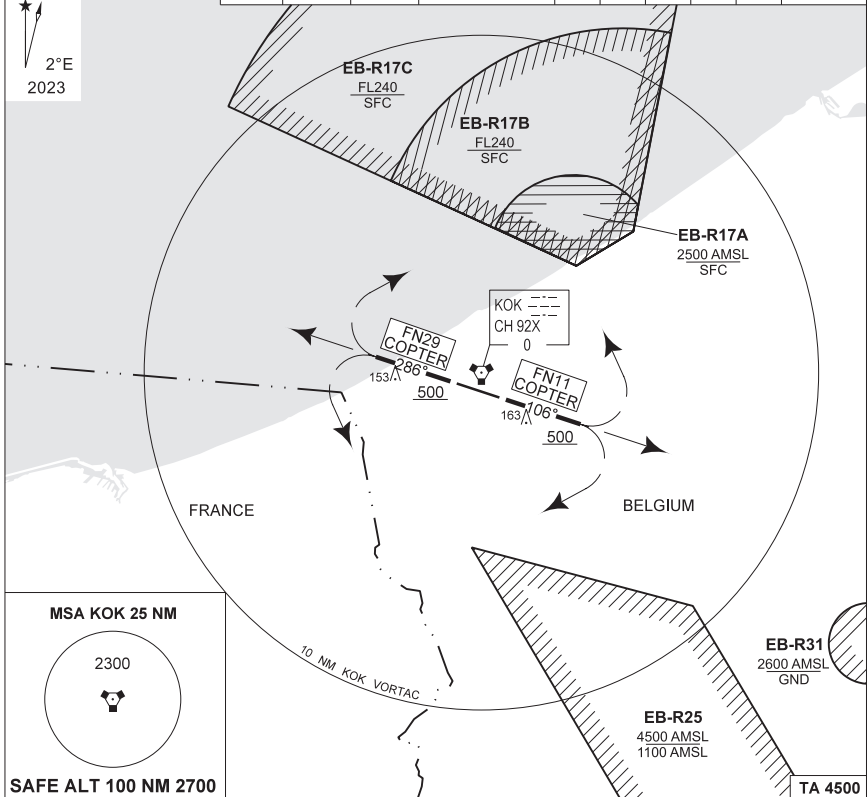

<p>FN 11 COPTER (RWY 11)</p> <p>10</p>	<p>- Climb straight ahead to 500 FT AMSL at 5% CG.</p> <p>- Turn as cleared by ATC while climbing to MSA.</p>
<p>FN 29 COPTER (RWY 29)</p> <p>10</p>	<p>- Climb straight ahead to 500 FT AMSL at 5% CG.</p> <p>- Turn as cleared by ATC while climbing to MSA.</p>

FN 11 COPTER - 29 COPTER

51°05.42' N
002°39.17' E

KOKSIJDE (EBFN)

CHANGE: Editorial

BELDEFENCE, AIR COMPONENT 16-APR-2026 - THS

MIPS
INSTRUMENT APPROACH CHART

HPMA-TACAN RWY 29
KOKSIJDE (EBFN)

AD ELEV 11

BELGA RADAR 374.400 129.325		KOKSIJDE APP 235.050 121.055		KOKSIJDE TWR 231.800 122.100		KOKSIJDE GND 231.800 122.100	
DVORTAC KOK 114.500 CH 92X	APP COURSE 304°	FAF ALT 1500 FT	DESCENT GR 5.24%(3.00°)	MDA 410	THR 11 FT	ALS 420 M	LDA 8446 FT

CAUTION:

- a) PROCEDURE FOR AIRCRAFT CATEGORY HPMA MAY ONLY BE EXECUTED WHEN EB-R24 A AND B AND EB-R25 IS ACTIVE.
- b) RADAR FLIGHT PATH MONITORING REQUIRED TO ENSURE AIRCRAFT REMAIN WITHIN CONTROLLED AIRSPACE.

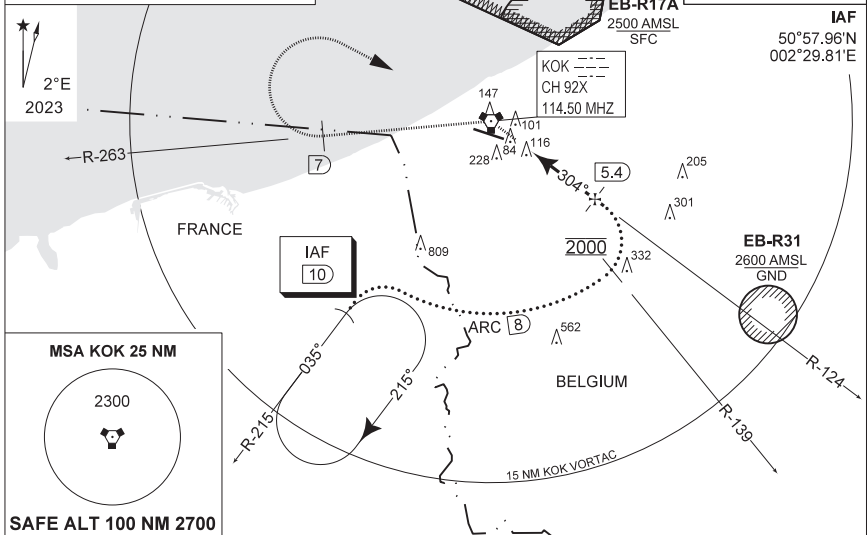
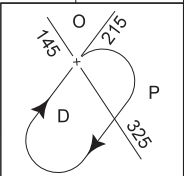
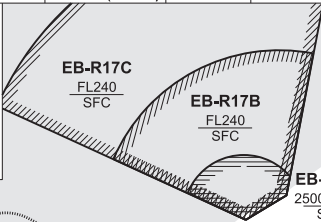

DME KOK	5	4	3	2
Altitude	1400	1080	770	440
Height	(1389)	(1069)	(759)	(429)

TA 4500

MISSED APPROACH

Intercept R-263 and climb to 2000 FT AMSL. At 7 DME passed KOK TACAN turn right inbound KOK TACAN at MAX 275 KIAS to intercept IAF TACAN RWY 29.

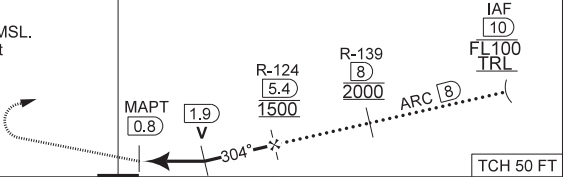

S-ALS	THR 11	4.6	TCH 50 FT
-------	--------	-----	-----------

CATEGORY	HPMA
S-TAC 29	410 - 1.8 399 (400 - 1.8 / 2.2)
S-PAR 29	211 - 0.8 200 (200 - 0.8 / 1.0) GS 3.00°

HPMA-TACAN RWY 29

51°05.42' N
002°39.17' E

KOKSIJDE (EBFN)

CHANGE: Editorial

BEL DEFENCE. AIR COMPONENT 19-APR-2026 - THIS

MIPS
INSTRUMENT APPROACH CHART

TACAN RWY 29
KOKSIJDE (EBFN)

AD ELEV 11

BELGA RADAR 374.400 129.325		KOKSIJDE APP 235.050 121.055		KOKSIJDE TWR 231.800 122.100		KOKSIJDE GND 231.800 122.100	
DVORTAC KOK 114.500 CH 92X	APP COURSE 304°	FAF ALT 1500 FT	DESCENT GR 5.24%(3.00°)	MDA 410	THR 11 FT	ALS 420 M	LDA 8446 FT

CAUTION:

- a) PROCEDURE FOR AIRCRAFT CATEGORY C AND D MAY ONLY BE EXECUTED WHEN EB-R24 A AND B AND EB-R25 IS ACTIVE.
- b) RADAR FLIGHT PATH MONITORING REQUIRED TO ENSURE AIRCRAFT REMAIN WITHIN CONTROLLED AIRSPACE.

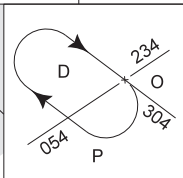
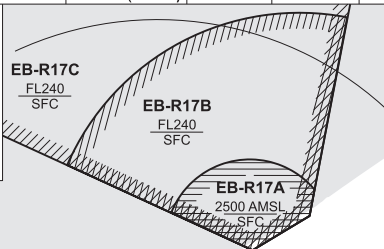

IAF
51°05.95'N
002°39.33'E

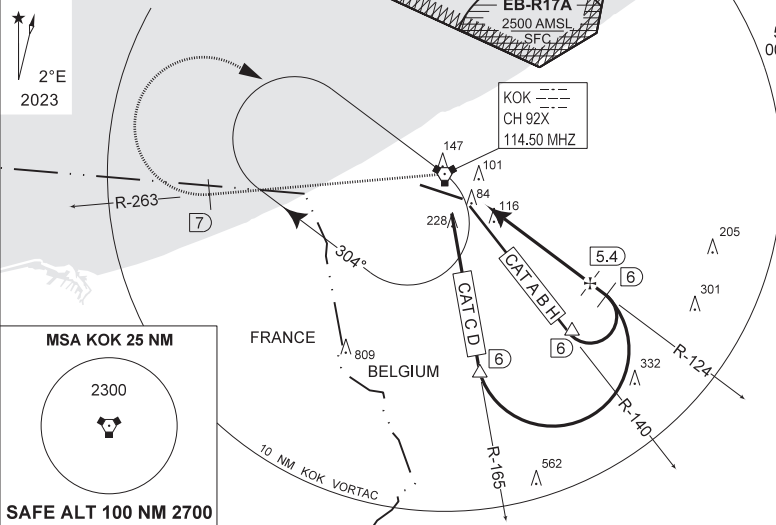

MSA KOK 25 NM

2300

SAFE ALT 100 NM 2700

DME KOK	5	4	3	2
Altitude	1400	1080	770	440
Height	(1389)	(1069)	(759)	(429)

TA 4500

MISSED APPROACH

Intercept R-263 and climb to 2000 FT AMSL.
At 7 DME passed KOK TACAN
(4 DME for category A, B & H) turn right
inbound KOK TACAN at MAX 250 KIAS
to intercept IAF TACAN RWY 29.

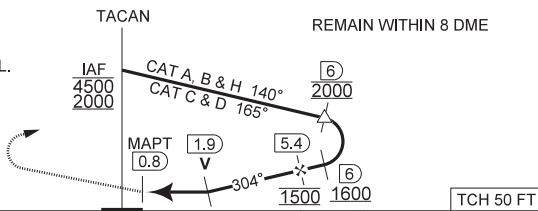

S-ALS	THR 11 FT	4.6	TCH 50 FT
-------	-----------	-----	-----------

CATEGORY	A - B	C - D	H
S-TAC 29	410 - 1.5 399 (400 - 1.5 / 2.2)	410 - 1.8 399 (400 - 1.8 / 2.2)	410 - 1.5 399 (400 - 1.5 / 2.2)
S-PAR 29	211 - 0.8 200 (200 - 0.8 / 1.0) GS 3.00°		162 - 0.4 151 (200 - 0.4 / 0.8) GS 3.00°

TACAN RWY 29

51°05.42' N
002°39.17' E

KOKSIJDE (EBFN)

CHANGE: Editorial

BELDEFENCE. AIR COMPONENT 16-APR-2026 - THS

MIPS
INSTRUMENT APPROACH CHART

VOR RWY 29
KOKSIJDE (EBFN)

AD ELEV 11

BELGA RADAR 374.400 129.325		KOKSIJDE APP 235.050 121.055			KOKSIJDE TWR 231.800 122.100		KOKSIJDE GND 231.800 122.100	
DVORTAC KOK 114.500 CH 92X	APP COURSE 295°	FAF ALT 1500 FT	DESCENT GR 5.24%(3.00°)	MDA 410	THR 11 FT	ALS 420 M	LDA 8446 FT	

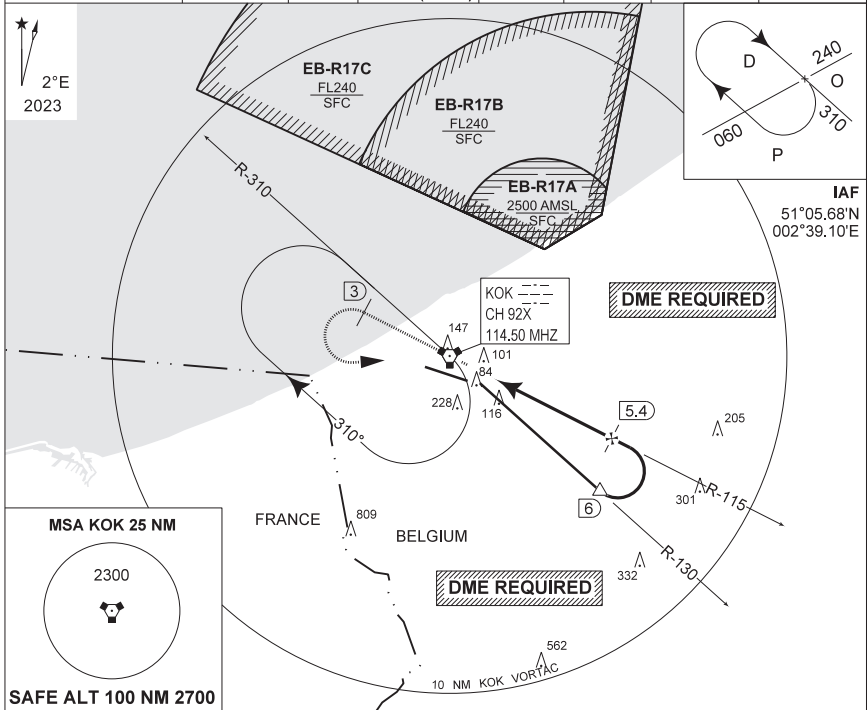

DME KOK	5	4	3	2	TA 4500
Altitude Height	1400 (1389)	1080 (1069)	760 (749)	440 (429)	

MISSED APPROACH
Continue straight ahead until 3 DME passed KOK VOR then turn left inbound KOK VOR at MAX 2000 FT AMSL except instructed otherwise by ATC.

S-ALS	THR 11 FT	4.6	TCH 50 FT
-------	-----------	-----	-----------

CATEGORY	A - B	H
S-VOR 29	410 - 1.5 399 (400 - 1.5 / 2.2)	
S-PAR 29	211 - 0.8 200 (200 - 0.8 / 1.0) GS 3.00°	162 - 0.4 151 (200 - 0.4 / 0.8) GS 3.00°

VOR RWY 29 51°05.42' N 002°39.17' E **KOKSIJDE (EBFN)**

CHANGE: Editorial

BEL DEFENCE. AIR COMPONENT 16-APR-2026 - THIS

MIPS
AERODROME CHART

LEEWARDEN (EHLW)

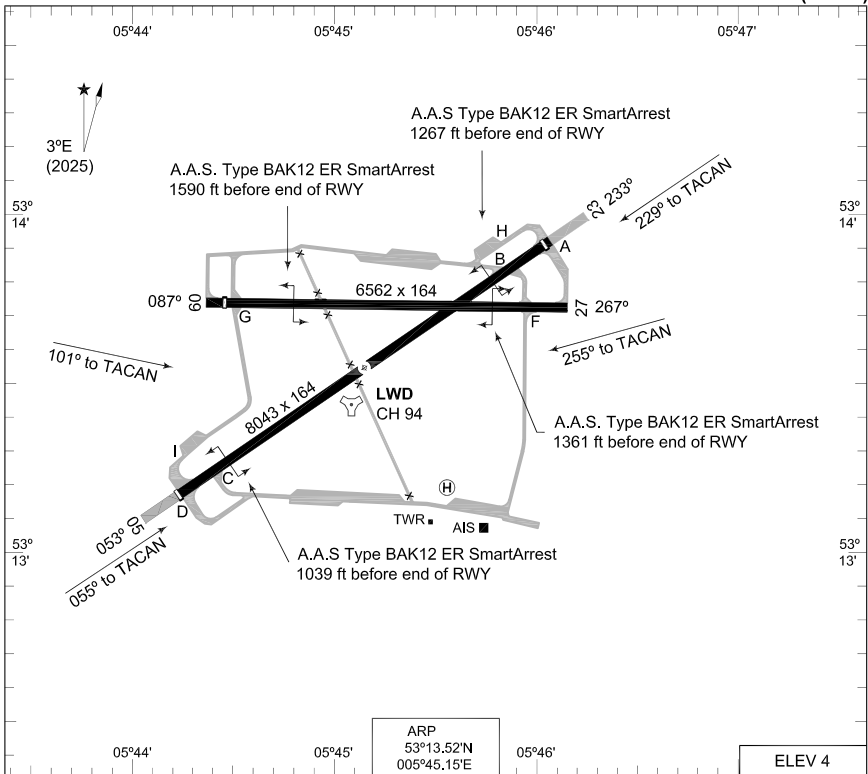

RWY	PCN	TORA	ASDA	TODA	LDA	PAPI	THR ELEV	THR PSN
23	64 F/B/W/T	8043	8043	8832	7863	3.0°	4	53°13.88'N 005°46.04'E
05	64 F/B/W/T	8043	8043	8865	8036	3.0°	4	53°13.15'N 005°44.27'E
27	52 F/B/W/T	6561	6561	6561	6561		3	53°13.71'N 005°46.18'E
09	52 F/B/W/T	6561	6561	6561	6368		3	53°13.71'N 005°44.44'E

LEEWARDEN TWR 344.850 120.705 (Ground Control) 362.525
 LEEWARDEN ARRIVAL 339.700
 RAPCON NORTH 284.475 132.030

SRA	PROC. CRITERIA	RWY	GS	TCH	OTCH	RPI	CAT	MINIMA CRITERIA	MINIMA
	MIPS	23					AB	MIPS	450-1100 446 (500-1.1/1.9)
							C		450-1200 446 (500-1.2/2.0)
	D	450-1600 446 (500-1.6/2.4)							
	E	450-2000 446 (500-2.0/2.8)							
	MIPS	05				AB	MIPS	470-1100 446 (500-1.1/1.9)	
						C		470-1200 446 (500-1.2/2.0)	
	D	470-1600 446 (500-1.6/2.4)							
	E	470-2000 446 (500-2.0/2.8)							
	MIPS	27				AB	MIPS	420-1900 417 (500-1.9/1.9)	
						CD		420-2000 417 (500-2.0/2.0)	
	E	420-2400 417 (500-2.4/2.4)							
	MIPS	09				AB	MIPS	460-1900 458 (500-1.9/1.9)	
						C		460-2000 458 (500-2.0/2.0)	
	DE	460-2400 458 (500-2.4/2.4)							

AERODROME CHART

LEEWARDEN (EHLW)

CHANGES: EDITORIAL

RNLASF 16 APR 2026

**TERPS
INSTRUMENT DEPARTURE CHART**

**LW1
LEEWARDEN (EHLW)**

GND CTL 362.525		LEEWARDEN TWR 344.850 120.705		AD ELEV 4		RAPCON NORTH 284.475 132.030		DUTCH MIL 259.250 128.355			
				RWY 23	Knots V/V (fpm)	120 600	180 900	240 1200	300 1500	360 1800	to 1000 ft

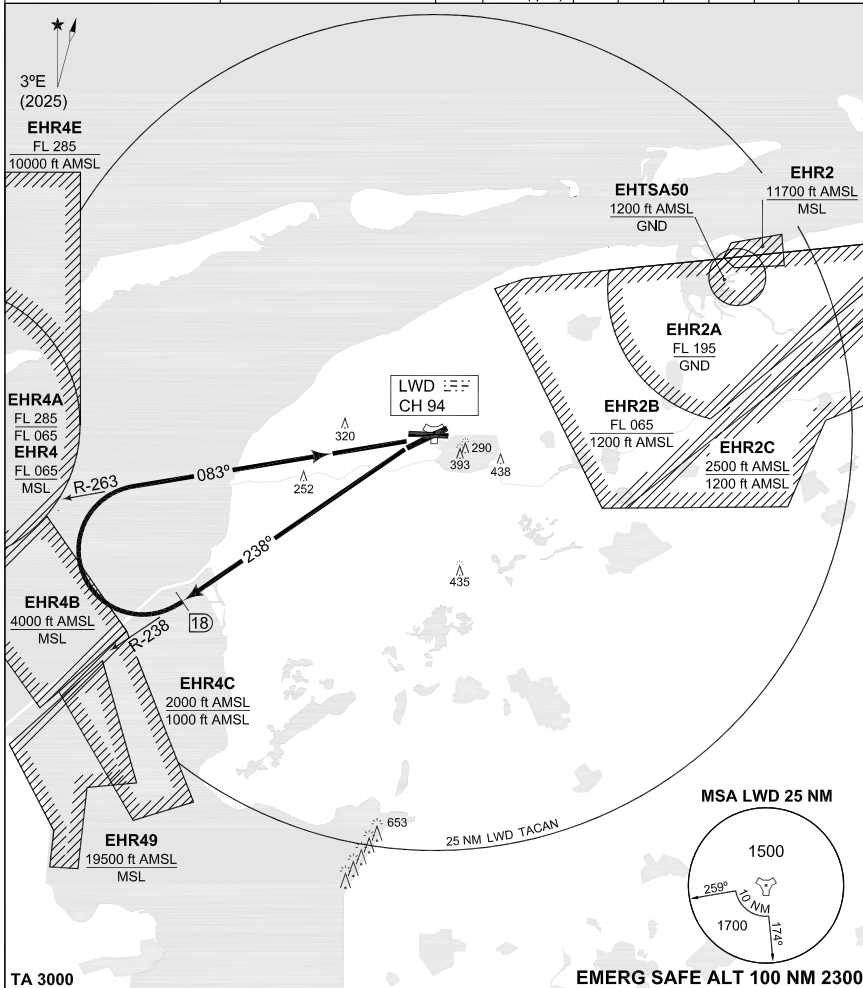

TA 3000

EMERG SAFE ALT 100 NM 2300

**LEEWARDEN 1
(RWY 23)**

- Climb on R-238 outbound Leeuwarden TACAN.
- At 18 DME turn right to intercept R-263 inbound and proceed to Leeuwarden TACAN.

NOTE: Procedure may be changed by ATC when BREEZANDDIJK firing range is active.

LW1

53°13.52'N
005°45.15'E

LEEWARDEN (EHLW)

**TERPS
INSTRUMENT DEPARTURE CHART**

**LW3
LEEWARDEN (EHLW)**

GND CTL 362.525	LEEWARDEN TWR 344.850 120.705	AD ELEV 4				RAPCON NORTH 284.475 132.030				DUTCH MIL 259.250 128.355			
		RWY 05	Knots V/V (fpm)	120 540	180 810	240 1080	300 1350	360 1620	to 1000 ft				

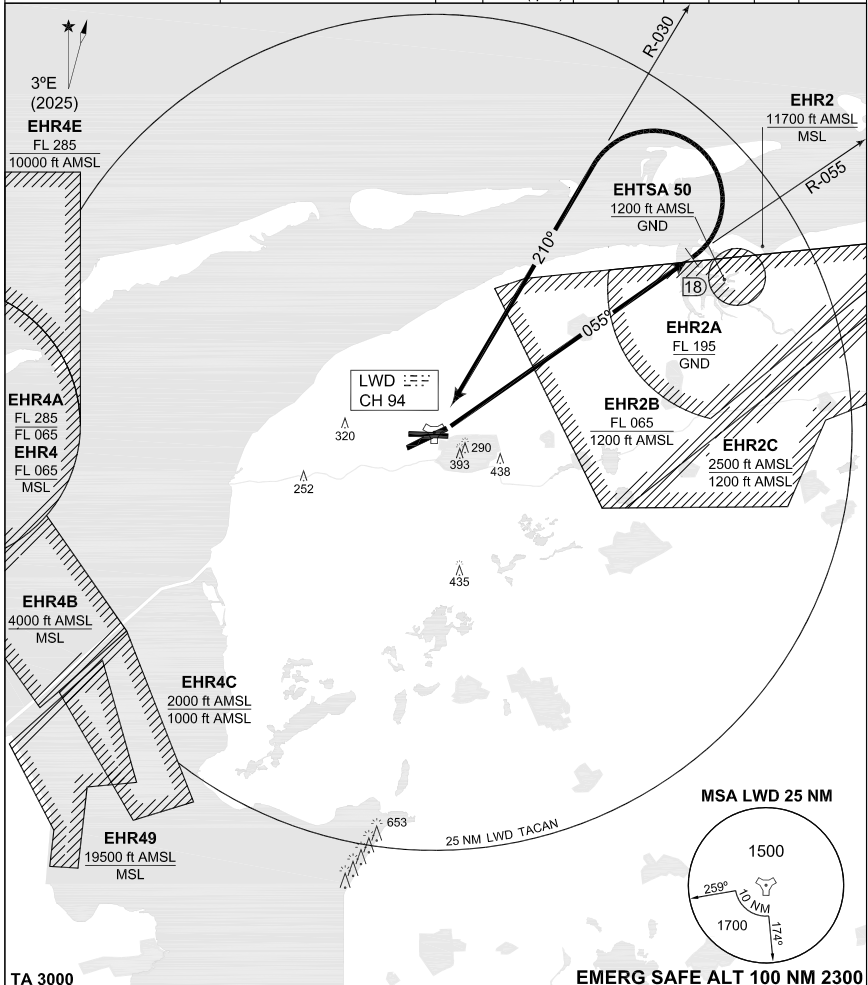

TA 3000

EMERG SAFE ALT 100 NM 2300

**LEEWARDEN 3
(RWY 05)**

- Climb on R-055 outbound Leeuwarden TACAN.
- At 18 DME turn left to intercept R-030 inbound and proceed to Leeuwarden TACAN.

LW3

53°13.52'N
005°45.15'E

LEEWARDEN (EHLW)

CHANGES: EDITORIAL

RNLASF 16 APR 2026

**TERPS
INSTRUMENT DEPARTURE CHART**

**LW5
LEEUWARDEN (EHLW)**

GND CTL 362.525	LEEUWARDEN TWR 344.850 120.705	AD ELEV 4				RAPCON NORTH				DUTCH MIL			
		284.475		132.030		259.250		128.355					
		RWY	Knots	120	180	240	300	360	to				
		27	V/V (fpm)	550	825	1100	1375	1700	1000 ft				

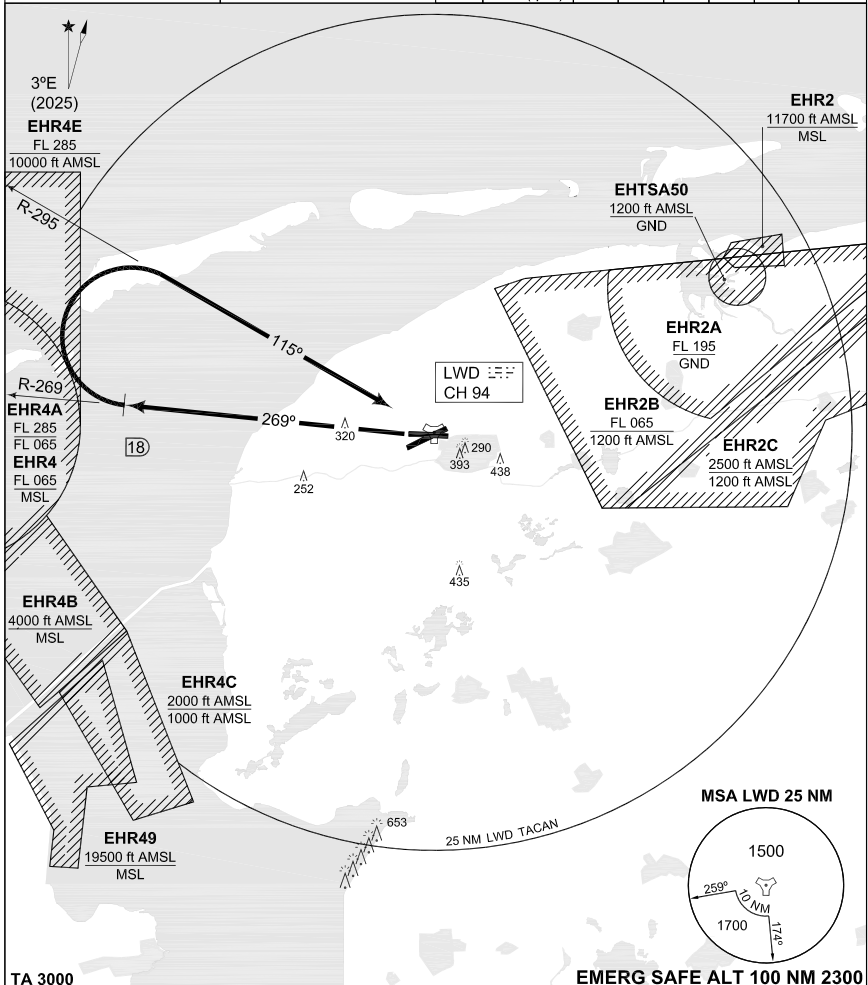

TA 3000

EMERG SAFE ALT 100 NM 2300

**LEEUWARDEN 5
(RWY 27)**

- After take-off RWY 27 intercept R-269 outbound Leeuwarden TACAN.
- At 18 DME turn right to intercept R-295 inbound Leeuwarden TACAN.

LW5

53°13.52'N
005°45.15'E

LEEUWARDEN (EHLW)

CHANGES: EDITORIAL

RNLASF 16 APR 2026

**TERPS
INSTRUMENT DEPARTURE CHART**

**LW7
LEEUWARDEN (EHLW)**

GND CTL 362.525	LEEUWARDEN TWR 344.850 120.705	RAPCON NORTH 284.475 132.030				DUTCH MIL 259.250 128.355			
		RWY 09	Knots V/V (fpm)	120 750	180 1125	240 1500	300 1875	360 2250	to 1000 ft

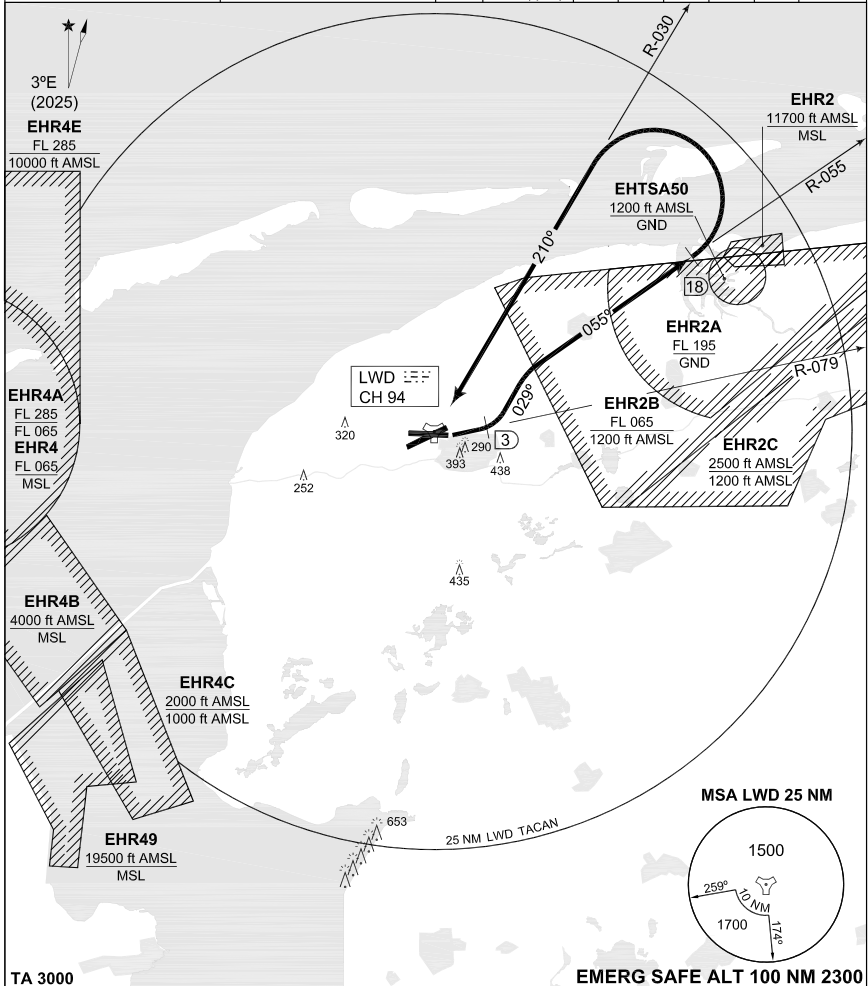

TA 3000

EMERG SAFE ALT 100 NM 2300

**LEEUWARDEN 7
(RWY 09)**

- After take-off intercept R-079 outbound Leeuwarden TACAN.
- At 3 DME turn left heading 029° to intercept R-055 Leeuwarden TACAN.
- At 18 DME turn left to intercept R-030 inbound Leeuwarden TACAN.

LW7

53°13.52'N
005°45.15'W

LEEUWARDEN (EHLW)

MIPS
INSTRUMENT APPROACH CHART

ILS or LOC RWY 05
LEEWARDEN (EHLW)

AD ELEV 4

DUTCH MIL 259.250 128.355		RAPCON NORTH 284.475 132.030		LEEWARDEN TWR 344.850 120.705		GND CTL 362.525		
LOCALIZER / DME LWZ 111.750 / CH 54Y		APP COURSE 053°	GS INTCEPT ALT 1200 FT	GS 3°	DA SEE CAT	THR ELEV 4	ALS 660 m	LDA 8036 FT

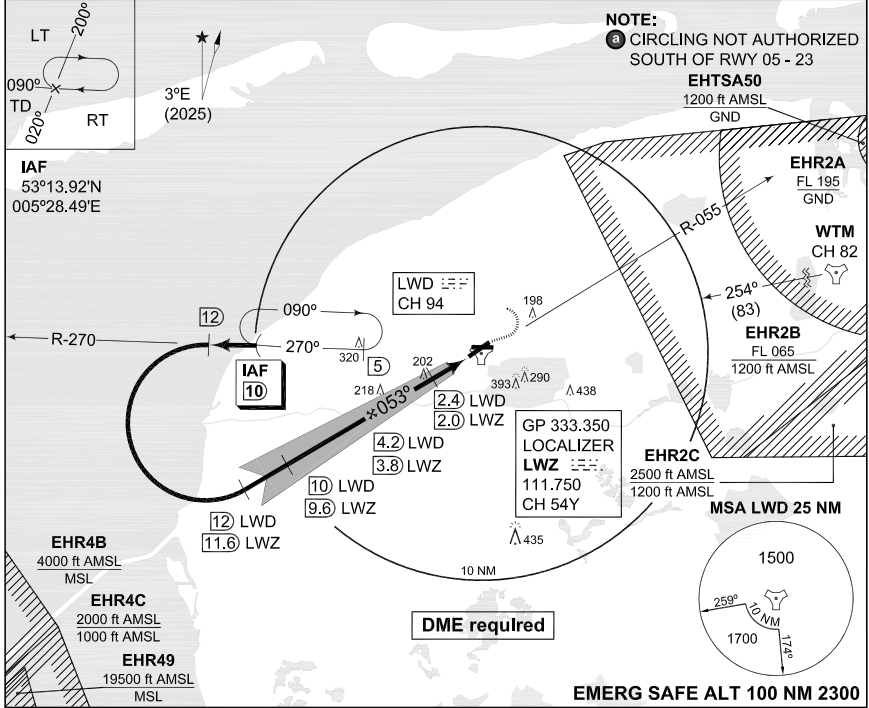

EMERG SAFE ALT 100 NM 2300

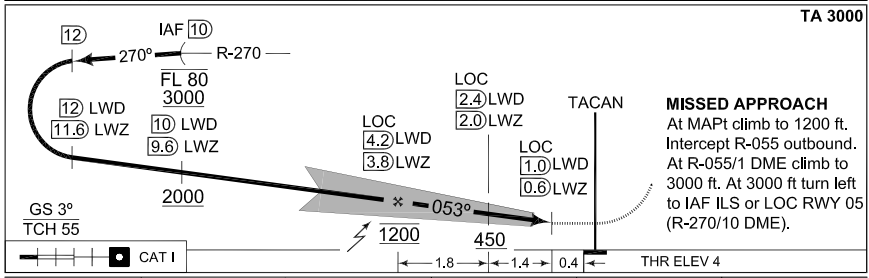

TA 3000

CATEGORY	A	B	C	D	E
MINIMA ACCORDING TO PANS-OPS; NOT ACCORDING TO APATC-1					
S-ILS 05	204-800 200 (200-0.8/1.6)	208-800 204 (300-0.8/1.6)	218-800 214 (300-0.8/1.6)	227-800 223 (300-0.8/1.6)	246-800 242 (300-0.8/1.6)
S-LOC 05	350-800 346 (400-0.8/1.6)		350-1200 346 (400-1.2/1.6)	350-1200 346 (400-1.2/2.0)	
CIRCLING	500-1900 496 (500-1.9)	510-2800 506 (600-2.8)	610-3700 606 (700-3.7)	720-4600 716 (800-4.6)	820-6500 816 (900-6.5)

ILS or LOC RWY 05 53°13.52'N 005°45.15'E **LEEWARDEN (EHLW)**

CHANGES: EDITORIAL

RNLASF 16 APR 2025

MIPS
INSTRUMENT APPROACH CHART

HI-TACAN RWY 05
LEEWARDEN (EHLW)

DUTCH MIL 259.250 128.355		RAPCON NORTH 284.475 132.030		LEEWARDEN TWR 344.850 120.705		GND CTL 362.525	
TACAN LWD CH 94	APP COURSE 055°	FAF ALT 1200 FT	Descent GR	MDA 380	THR ELEV 4	ALS 660 m	LDA 8036 FT

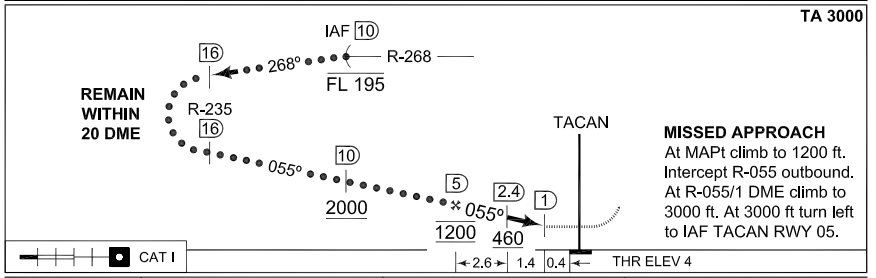
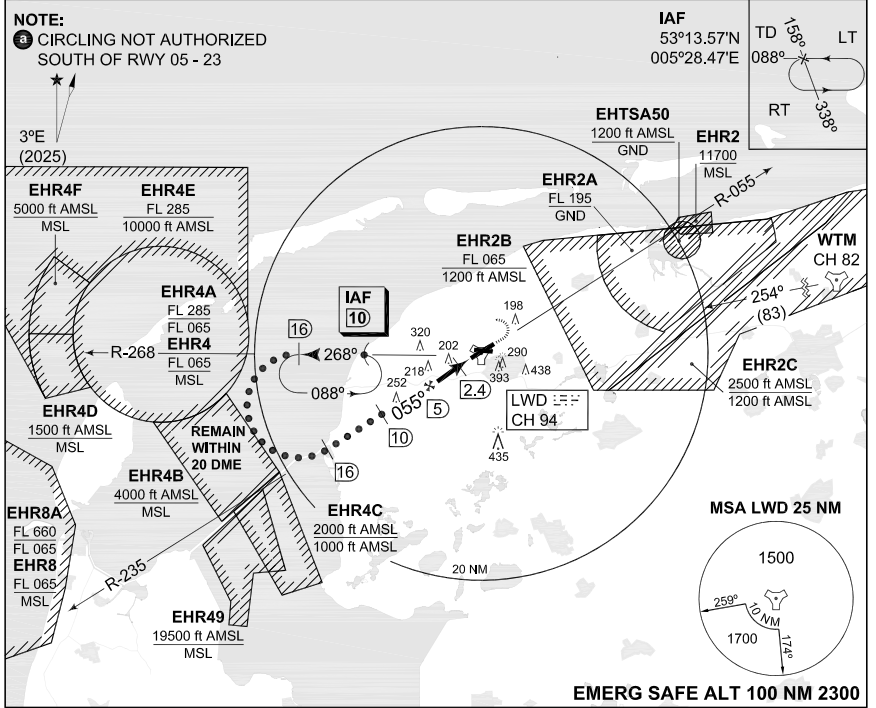

CATEGORY	C	D	E
MINIMA ACCORDING TO PANS-OPS; NOT ACCORDING TO APATC-1			
S-TACAN 05	380-1200 376 (400-1.2/1.6)	380-1200 376 (400-1.2/2.0)	
CIRCLING ⓐ	610-3700 606 (700-3.7)	720-4600 716 (800-4.6)	820-6500 816 (900-6.5)

HI-TACAN RWY 05

53°13.52'N
005°45.15'E

LEEWARDEN (EHLW)

MIPS
INSTRUMENT APPROACH CHART

TACAN RWY 05
LEEWARDEN (EHLW)

AD ELEV 4

DUTCH MIL 259.250 128.355		RAPCON NORTH 284.475 132.030		LEEWARDEN TWR 344.850 120.705		GND CTL 362.525	
TACAN LWD CH 94	APP COURSE 055°	FAF ALT 1200 FT	Descent GR	MDA 380	THR ELEV 4	ALS 660 m	LDA 8036 FT

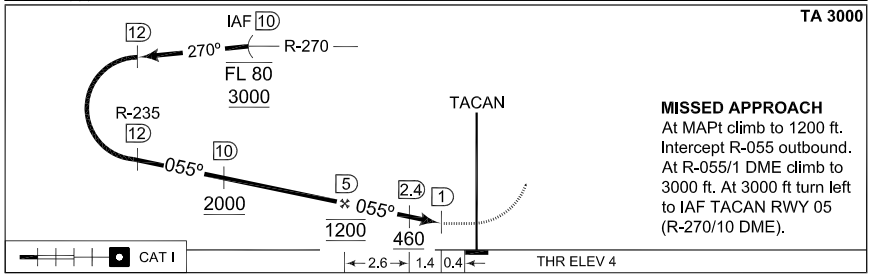
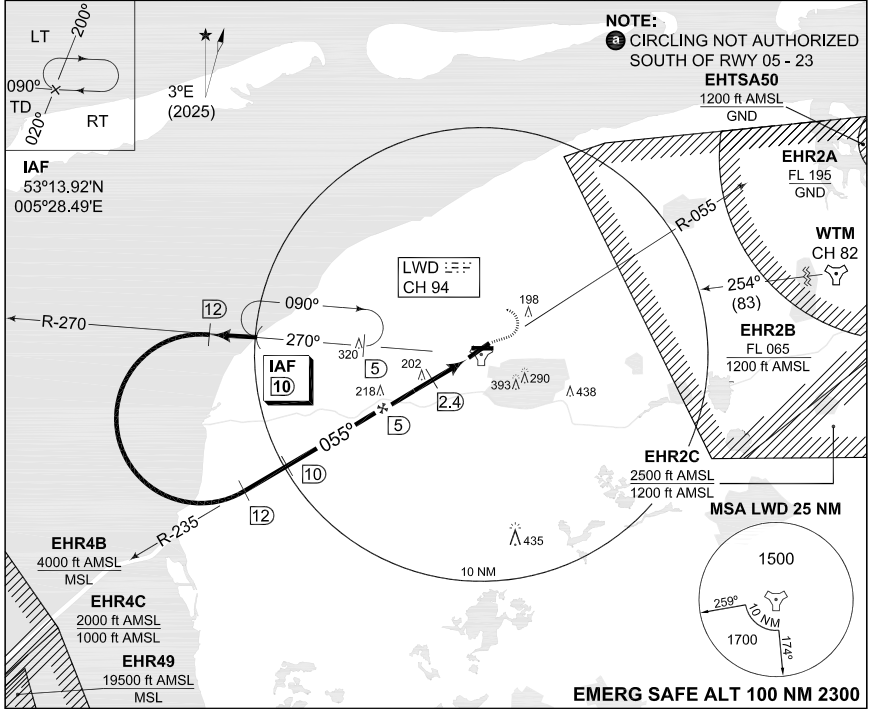

CATEGORY	A	B	C	D	E
MINIMA ACCORDING TO PANS-OPS; NOT ACCORDING TO APATC-1					
S-TACAN 05	380-800 376 (400-0.8/1.6)		380-1200 376 (400-1.2/1.6)	380-1200 376 (400-1.2/2.0)	
CIRCLING ③	500-1900 496 (500-1.9)	510-2800 506 (600-2.8)	610-3700 606 (700-3.7)	720-4600 716 (800-4.6)	820-6500 816 (900-6.5)

TACAN RWY 05

53°13.52'N
005°45.15'E

LEEWARDEN (EHLW)

MIPS INSTRUMENT APPROACH CHART

COPTER ILS or LOC 053 LEEUWARDEN (EHLW)

AD ELEV 4

DUTCH MIL 259.250 128.355		RAPCON NORTH 284.475 132.030		LEEUWARDEN TWR 344.850 120.705		GND CTL 362.525	
LOCALIZER / DME LWZ 111.750 / CH 54Y		APP COURSE 053°	GS INTCEPT ALT 1200 FT	GS 3°	DA 204	THR ELEV 4	ALS LDA 660 m 8036 FT

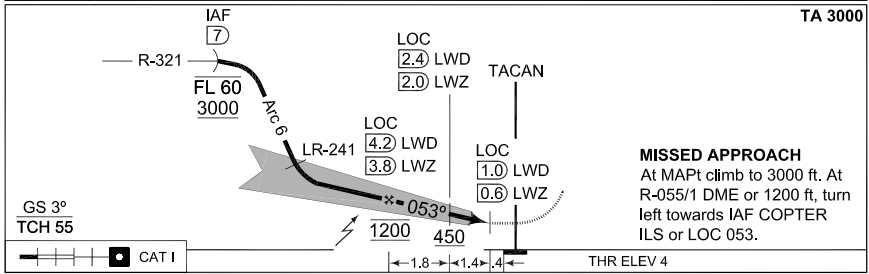
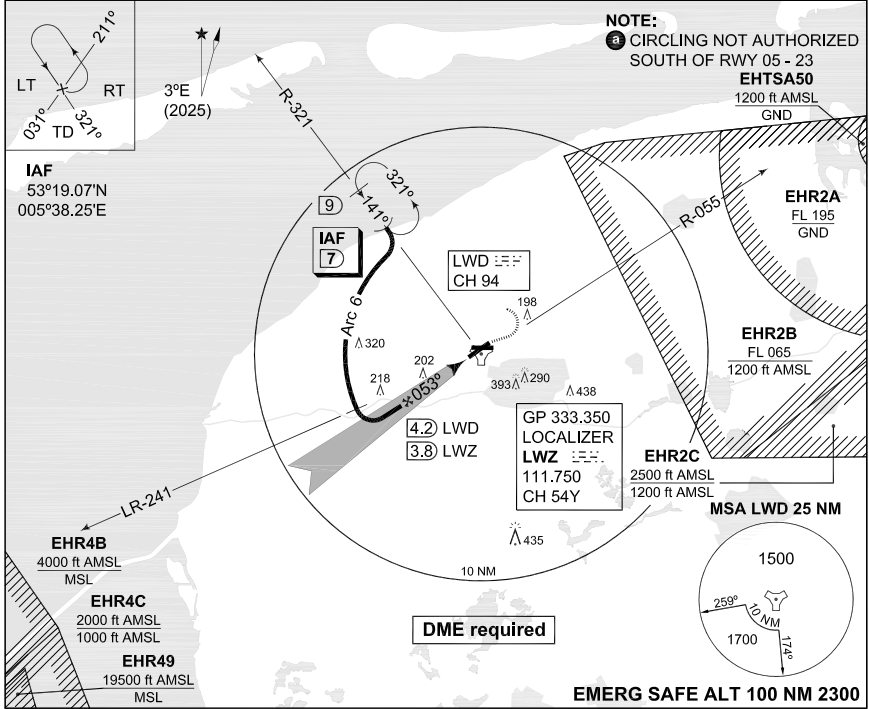

CATEGORY	H
MINIMA ACCORDING TO PANS-OPS; NOT ACCORDING TO APATC-1	
S-ILS 053	204-400 200 (200-0.4/0.8)
S-LOC 053	350-400 346 (400-0.4/0.8)
CIRCLING ⑥	500-1900 496 (500-1.9)

COPTER ILS or LOC 053

53°13.52'N
005°45.15'E

LEEUWARDEN (EHLW)

MIPS
INSTRUMENT APPROACH CHART

COPTER TACAN 055
LEEUWARDEN (EHLW)

AD ELEV 4

DUTCH MIL 259.250 128.355		RAPCON NORTH 284.475 132.030		LEEUWARDEN TWR 344.850 120.705		GND CTL 362.525	
TACAN LWD CH 94	APP COURSE 055°	FAF ALT 1200 FT	Descent GR	MDA 380	THR ELEV 4	ALS 660 m	LDA 8036 FT

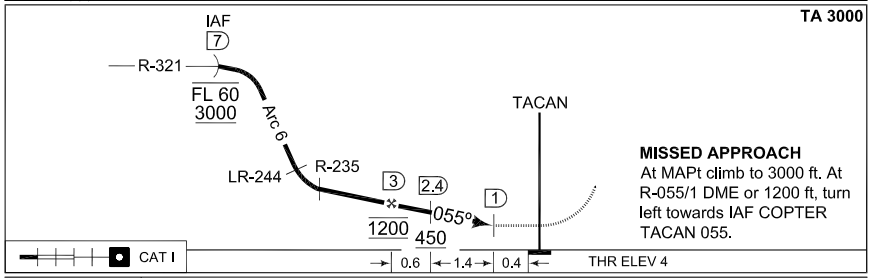
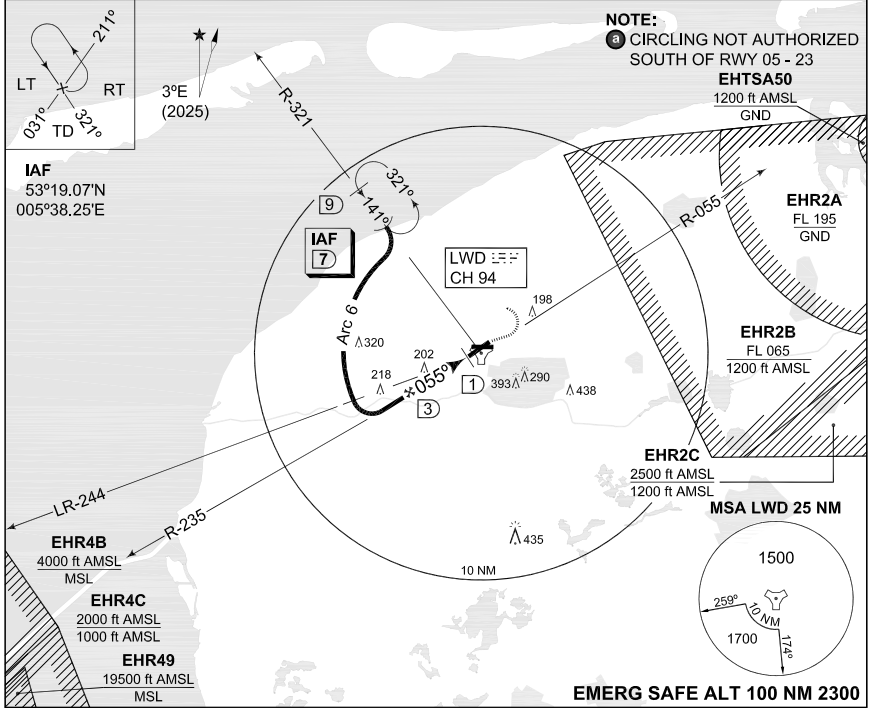

CATEGORY	A
COPTER TACAN 055	380-400 376 (400-0.4/0.8)
CIRCLING ⑥	500-1900 496 (500-1.9)

COPTER TACAN 055

53°13.52'N
005°45.15'E

LEEUWARDEN (EHLW)

CHANGES: EDITORIAL

MIPS

RNLASF 16 APR 2026

**PANS OPS
INSTRUMENT APPROACH CHART**

AD ELEV 4

**RNP Y RWY 05
LEEUWARDEN (EHLW)**

DUTCH MIL 259.250 128.355		RAPCON NORTH 284.475 132.030		LEEUWARDEN TWR 344.850 120.705		GND CTL 362.525	
EGNOS CHANNEL 67430 E05A	APP COURSE 053°	FAF ALT 1500 FT	Descent GR 6.5% / 3.72°	MDA 380	DA 204	THR ELEV 4	ALS LDA 660 m 8036 FT

NOTE:

- a) ALL DISTANCES ARE RELATED TO THRESHOLD
- b) PAPI 3° - NOT ALIGNED WITH INSTRUMENT PROCEDURE VERTICAL PATH

**RNP APCH
CAT H ONLY**

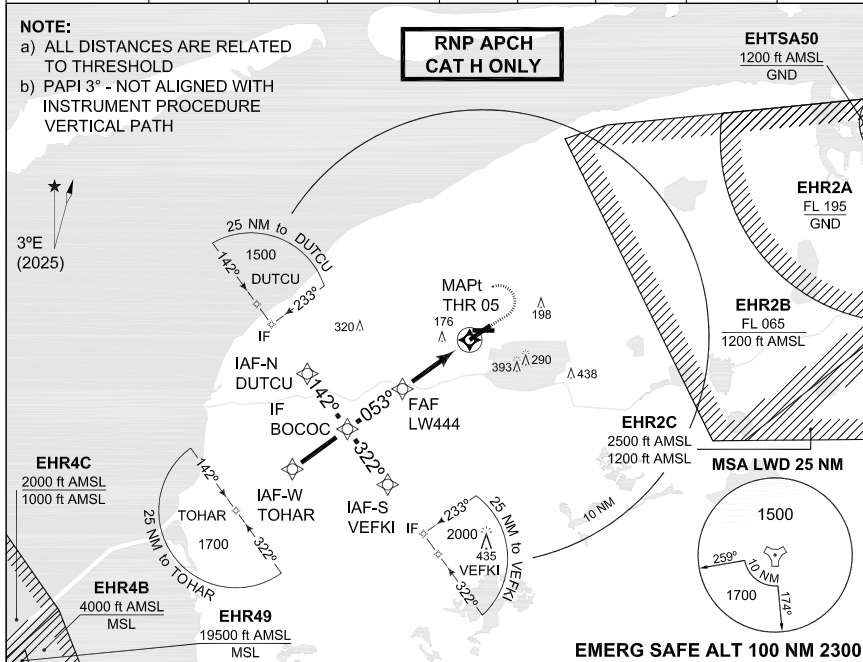

EMERG SAFE ALT 100 NM 2300

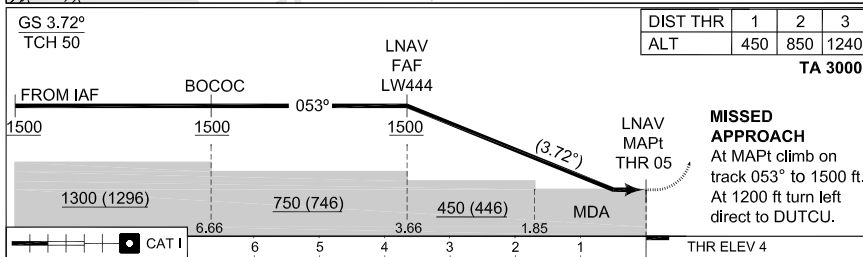

MISSED APPROACH
At MAPt climb on track 053° to 1500 ft. At 1200 ft turn left direct to DUTCU.

CATEGORY		H					
MIPS	DA(H) LPV	204-400 200 (200-0.4/1.2)					
	DA(H) LNAV / VNAV	N.A.					
	MDA(H) LNAV	380-1300 376 (400-1.3/1.7)					
IAF-N	DUTCU	53°11.83'N	005°32.32'E	IF	BOCOC	53°09.37'N	005°35.16'E
IAF-W	TOHAR	53°07.66'N	005°31.07'E	FAF	LW444	53°11.07'N	005°39.26'E
IAF-S	VEFKI	53°06.90'N	005°38.00'E	MAPt	THR05	53°13.15'N	005°44.27'E

RNP Y RWY 05

53°13.52'N
005°45.15'E

LEEUWARDEN (EHLW)

CHANGES: EDITORIAL

RNLASF 16 APR 2026

MIPS
INSTRUMENT APPROACH CHART

ILS or LOC RWY 09
LEEUWARDEN (EHLW)

AD ELEV 4

DUTCH MIL 259.250 128.355		RAPCON NORTH 284.475 132.030		LEEUWARDEN TWR 344.850 120.705		GND CTL 362.525		
LOCALIZER / DME WOL 109.750 / CH 34Y		APP COURSE 087°	GS INTCEPT ALT 1200 FT	GS 3°	DA SEE CAT	THR ELEV 3	ALS -	LDA 6368 FT

NOTE:
Ⓢ CIRCLING NOT AUTHORIZED SOUTH OF RWY 05 - 23

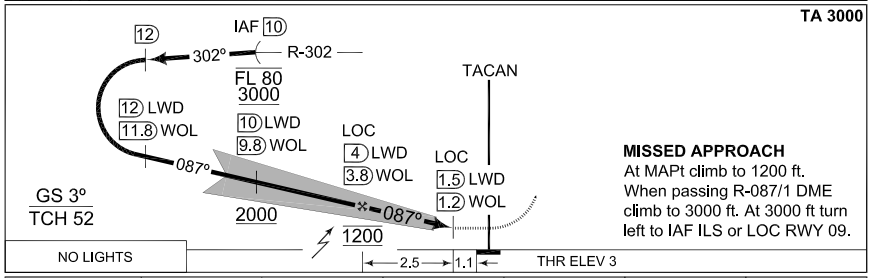
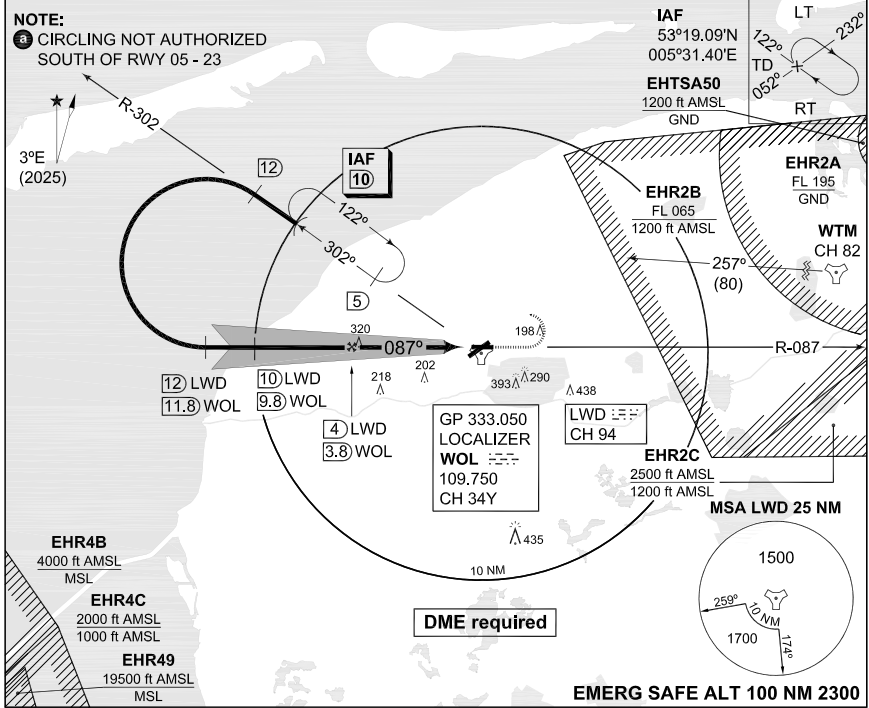

CATEGORY	MINIMA ACCORDING TO PANS-OPS: NOT ACCORDING TO APATC-1					
	A	B	C	D	E	H
S-ILS 09	221-1600 218 (300-1.6/1.6)	231-1600 228 (300-1.6/1.6)	240-1600 237 (300-1.6/1.6)	250-1600 247 (300-1.6/1.6)	268-1600 265 (300-1.6/1.6)	205-800 202 (300-0.8/0.8)
S-LOC 09	430-1600 427 (500-1.6/1.6)	430-2000 427 (500-2.0/2.0)	430-2400 427 (500-2.4/2.4)	430-2400 427 (500-2.4/2.4)	430-800 427 (500-0.8/0.8)	N.A.
CIRCLING Ⓢ	500-1900 496 (500-1.9)	510-2800 506 (600-2.8)	610-3700 606 (700-3.7)	720-4600 716 (800-4.6)	820-6500 816 (900-6.5)	N.A.

ILS or LOC RWY 09 53°13.52'N 005°45.15'E **LEEUWARDEN (EHLW)**

CHANGES: EDITORIAL

RNLASF 16 APR 2026

MIPS
INSTRUMENT APPROACH CHART

HI-TACAN RWY 09
LEEWARDEN (EHLW)

AD ELEV 4

DUTCH MIL 259.250 128.355		RAPCON NORTH 284.475 132.030		LEEWARDEN TWR 344.850 120.705		GND CTL 362.525	
TACAN LWD CH 94	APP COURSE 101°	FAF ALT 1200 FT	Descent GR	MDA 440	THR ELEV 3	ALS -	LDA 6368 FT

NOTE:
ⓐ CIRCLING NOT AUTHORIZED SOUTH OF RWY 05 - 23

IAF
53°20.71'N
005°33.73'E

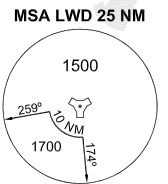
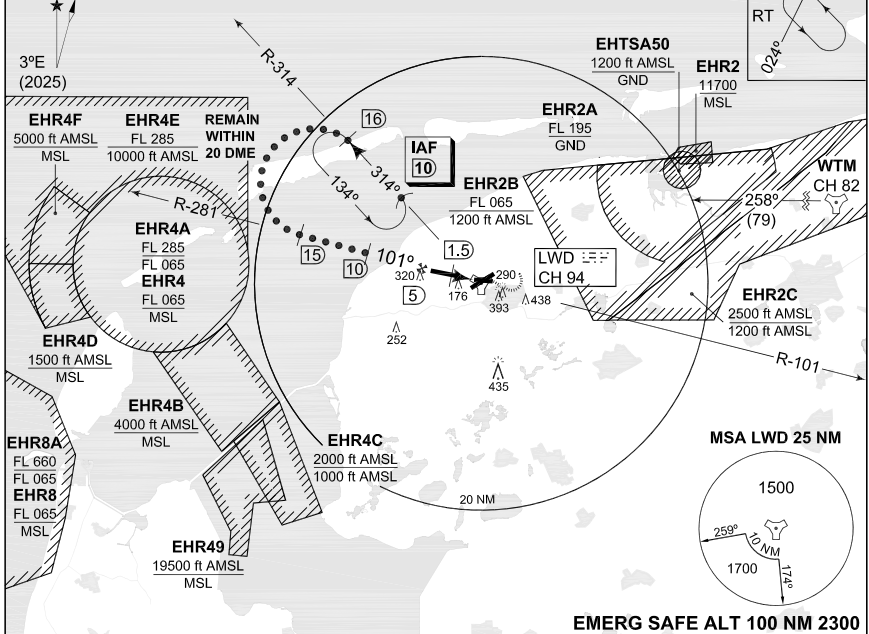
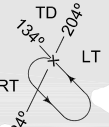

EMERG SAFE ALT 100 NM 2300

TA 3000

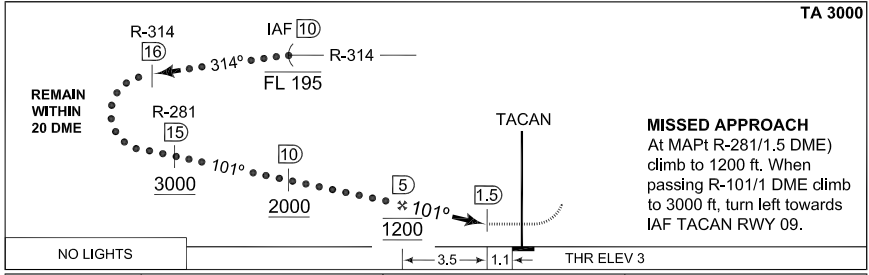

MISSED APPROACH
At MAPt R-281/1.5 (DME) climb to 1200 ft. When passing R-101/1 DME climb to 3000 ft, turn left towards IAF TACAN RWY 09.

CATEGORY	C	D	E
MINIMA ACCORDING TO PANS-OPS; NOT ACCORDING TO APATC-1			
S-TACAN 09	440-2000 437 (500-2.0/2.0)	440-2400 437 (500-2.4/2.4)	
CIRCLING ⓐ	610-3700 606 (700-3.7)	720-4600 716 (800-4.6)	820-6500 816 (900-6.5)

CHANGES: EDITORIAL

RNLASF 16 APR 2026

HI-TACAN RWY 09

53°13.52'N
005°45.15'E

LEEWARDEN (EHLW)

MIPS
INSTRUMENT APPROACH CHART

TACAN RWY 09
LEEWARDEN (EHLW)

AD ELEV 4

DUTCH MIL 259.250 128.355		RAPCON NORTH 284.475 132.030		LEEWARDEN TWR 344.850 120.705		GND CTL 362.525	
TACAN LWD CH 94	APP COURSE 101°	FAF ALT 1200 FT	Descent GR	MDA 440	THR ELEV 3	ALS -	LDA 6368 FT

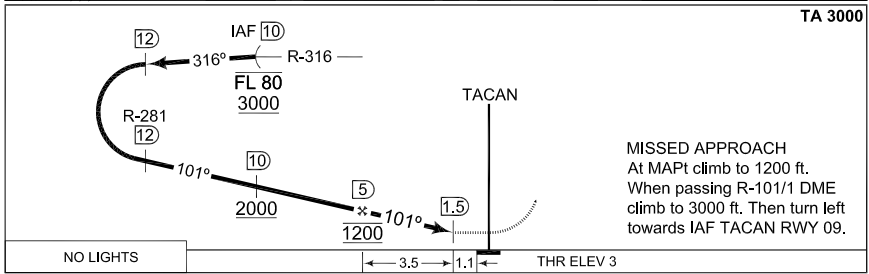
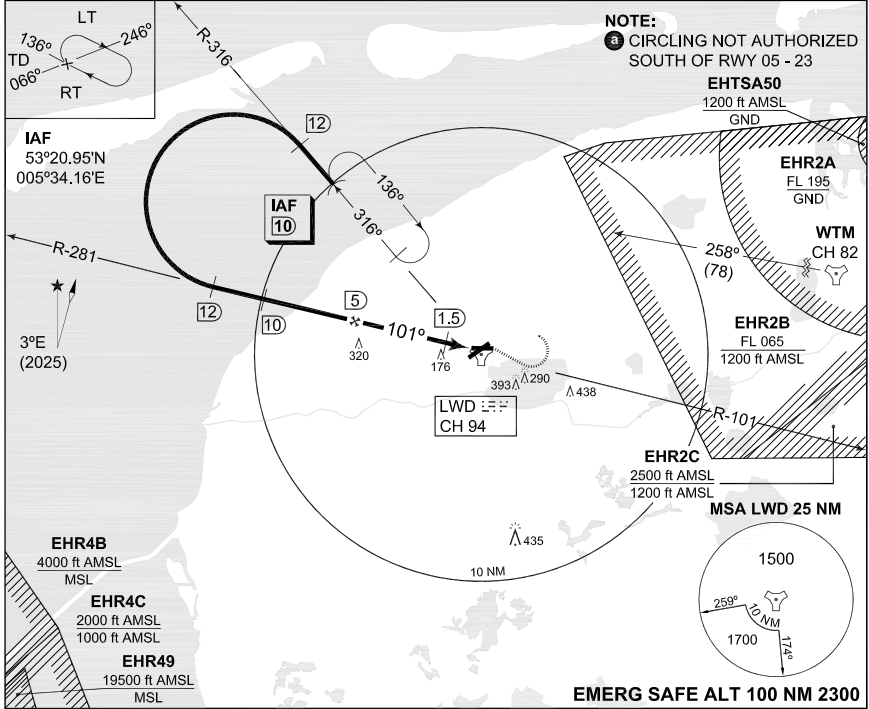

CATEGORY	A	B	C	D	E
MINIMA ACCORDING TO PANS-OPS; NOT ACCORDING TO APATC-1					
S-TACAN 09	440-1600 437 (500-1.6/1.6)	440-2000 437 (500-2.0/2.0)	440-2400 437 (500-2.4/2.4)		
CIRCLING ①	500-1900 496 (500-1.9)	510-2800 506 (600-2.8)	610-3700 606 (700-3.7)	720-4600 716 (800-4.6)	820-6500 816 (900-6.5)

TACAN RWY 09

53°13.52'N
005°45.15'E

LEEWARDEN (EHLW)

CHANGES: EDITORIAL

RNLASF 16 APR 2026

MIPS
INSTRUMENT APPROACH CHART

ILS or LOC RWY 23
LEEWARDEN (EHLW)

AD ELEV 4

DUTCH MIL 259.250 128.355		RAPCON NORTH 284.475 132.030		LEEWARDEN TWR 344.850 120.705		GND CTL 362.525	
LOCALIZER / DME LWO 111.750 / CH 54Y		APP COURSE 233°	GS INTCEPT ALT 1200 FT	GS 3°	DA SEE CAT	THR ELEV 4	ALS 720 m LDA 7863 FT

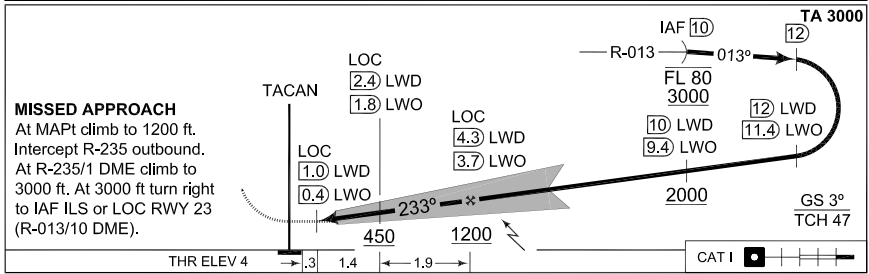
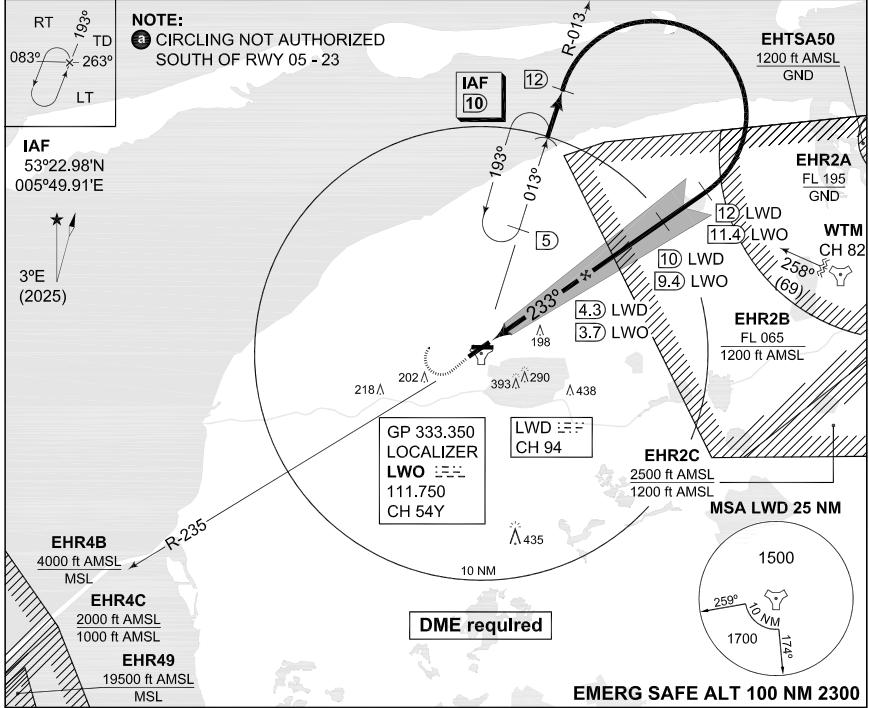

CATEGORY	A	B	C	D	E
MINIMA ACCORDING TO PANS-OPS; NOT ACCORDING TO APAT-1					
S-ILS 23	217-800 213 (300-0.8/1.6)	227-800 223 (300-0.8/1.6)	237-800 233 (300-0.8/1.6)	247-800 243 (300-0.8/1.6)	265-800 262 (300-0.8/1.6)
S-LOC 23	340-800 336 (400-0.8/1.6)		340-1200 336 (400-1.2/1.6)		340-1200 336 (400-1.2/2.0)
CIRCLING ①	500-1900 496 (500-1.9)	510-2800 506 (600-2.8)	610-3700 606 (700-3.7)	720-4600 716 (800-4.6)	820-6500 816 (900-6.5)

ILS or LOC RWY 23

53°13.52'N
005°45.15'E

LEEWARDEN (EHLW)

CHANGES: EDITORIAL

RNLASF 16 APR 2026

MIPS
INSTRUMENT APPROACH CHART

HI-TACAN RWY 23
LEEWARDEN (EHLW)

AD ELEV 4

DUTCH MIL 259.250 128.355		RAPCON NORTH 284.475 132.030		LEEWARDEN TWR 344.850 120.705		GND CTL 362.525	
TACAN LWD CH 94	APP COURSE 229°	FAF ALT 1200 FT	Descent GR	MDA 380	THR ELEV 4	ALS 720 m	LDA 7863 FT

NOTE:
ⓐ CIRCLING NOT AUTHORIZED SOUTH OF RWY 05 - 23

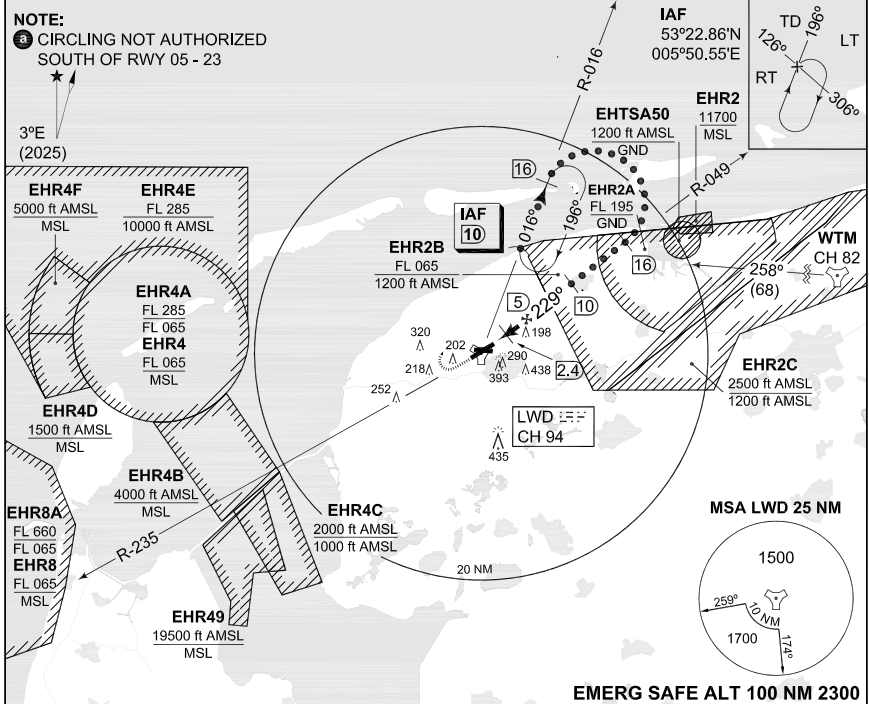

EMERG SAFE ALT 100 NM 2300

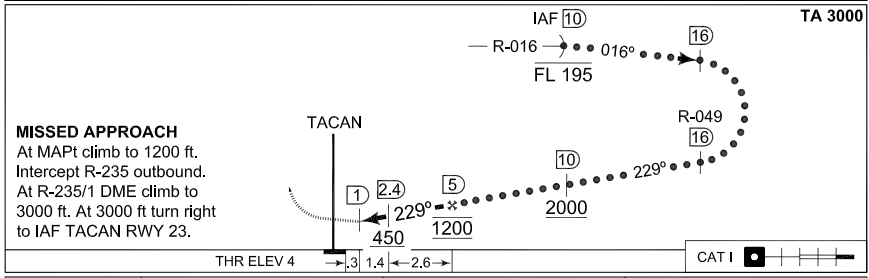

CATEGORY	C	D	E
	MINIMA ACCORDING TO PANS-OPS; NOT ACCORDING TO APATC-1		
S-TACAN 23	380-1200 376 (400-1.2/1.6)	380-1200 376 (400-1.2/2.0)	
CIRCLING ⓐ	610-3700 606 (700-3.7)	720-4600 716 (800-4.6)	820-6500 816 (900-6.5)

HI-TACAN RWY 23

53°13.52'N
005°45.15'E

LEEWARDEN (EHLW)

CHANGES: EDITORIAL

RNLASF 16 APR 2025

MIPS
INSTRUMENT APPROACH CHART

TACAN RWY 23
LEEUWARDEN (EHLW)

DUTCH MIL 259.250 128.355		RAPCON NORTH 284.475 132.030		LEEUWARDEN TWR 344.850 120.705		GND CTL 362.525		
TACAN LWD CH 94		APP COURSE 229°	FAF ALT 1200 FT	Descent GR	MDA 380	THR ELEV 4	ALS 720 m	LDA 7863 FT

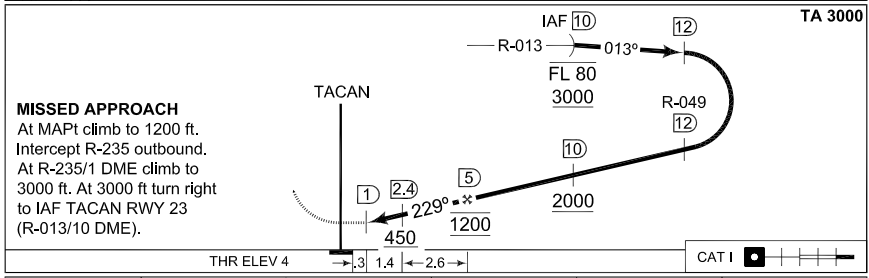
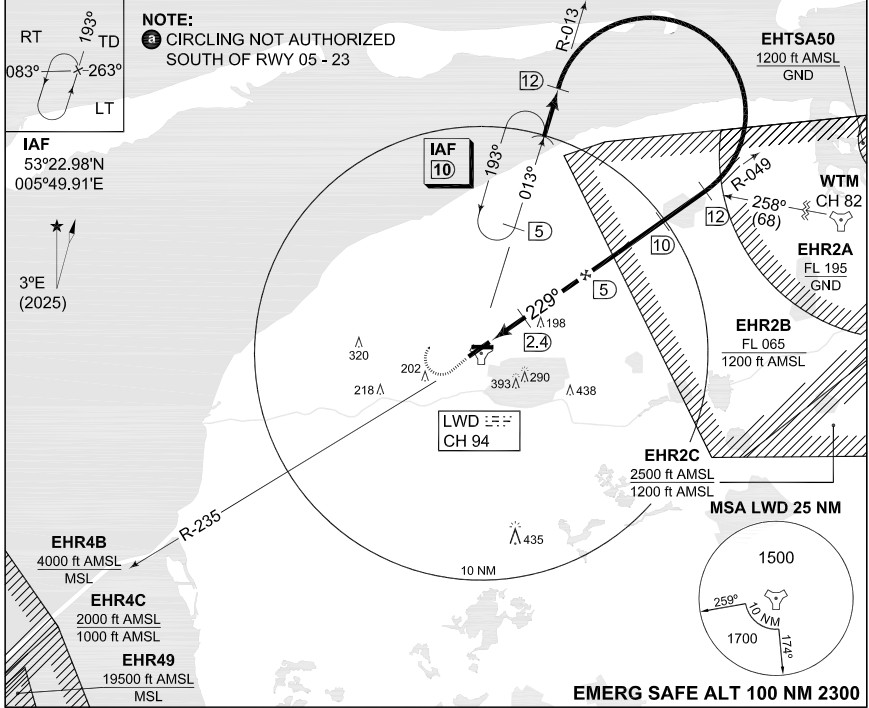

CATEGORY	A	B	C	D	E
MINIMA ACCORDING TO PANS-OPS; NOT ACCORDING TO APATC-1					
S-TACAN 23	380 -800 376 (400-0.8/1.6)	380 -1200 376 (400-1.2/1.6)	380 -1200 376 (400-1.2/2.0)	380 -1200 376 (400-1.2/2.0)	380 -1200 376 (400-1.2/2.0)
CIRCLING ⓐ	500 -1900 496 (500-1.9)	510 -2800 506 (600-2.8)	610 -3700 606 (700-3.7)	720 -4600 716 (800-4.6)	820 -6500 816 (900-6.5)

TACAN RWY 23 53°13.52'N 005°45.15'E **LEEUWARDEN (EHLW)**

CHANGES: EDITORIAL

RNLASF 16 APR 2025

MIPS
INSTRUMENT APPROACH CHART

COPTER ILS or LOC 233
LEEWARDEN (EHLW)

DUTCH MIL 259.250 128.355		RAPCON NORTH 284.475 132.030		LEEWARDEN TWR 344.850 120.705		GND CTL 362.525	
LOCALIZER / DME LWO 111.750 / CH 54Y		APP COURSE 233°	GS INTCEPT ALT 1200 FT	GS 3°	DA 204	THR ELEV 4	ALS LDA 720 m 7863 FT

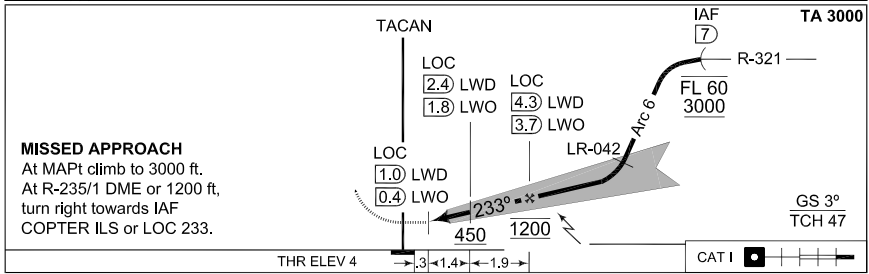
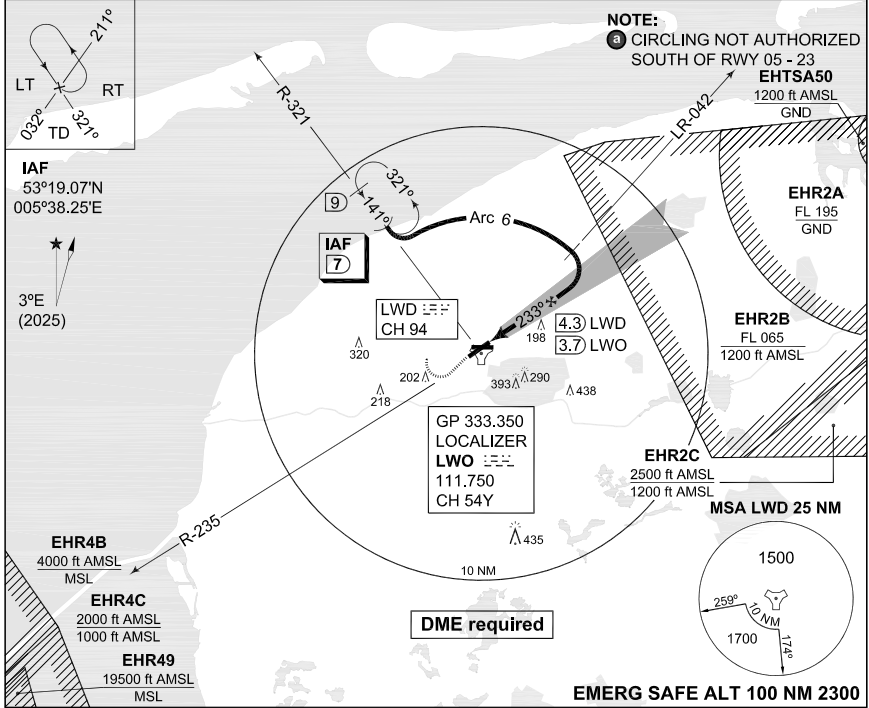

CATEGORY	H
MINIMA ACCORDING TO PANS-OPS; NOT ACCORDING TO APATC-1	
S-ILS 233	204 -400 200 (200-0.4/0.8)
S-LOC 233	340 -400 336 (400-0.4/0.8)
CIRCLING ③	500 -1900 496 (500-1.9)

CHANGES: EDITORIAL

RNLASF 16 APR 2026

MIPS
INSTRUMENT APPROACH CHART

COPTER TACAN 229
LEEWARDEN (EHLW)

DUTCH MIL 259.250 128.355		RAPCON NORTH 284.475 132.030		LEEWARDEN TWR 344.850 120.705		GND CTL 362.525	
TACAN LWD CH 94	APP COURSE 229°	FAF ALT 1200 FT	Descent GR	MDA 380	THR ELEV 4	ALS 720 m	LDA 7863 FT

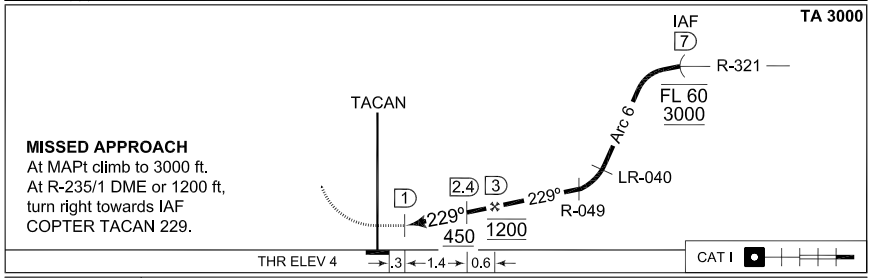
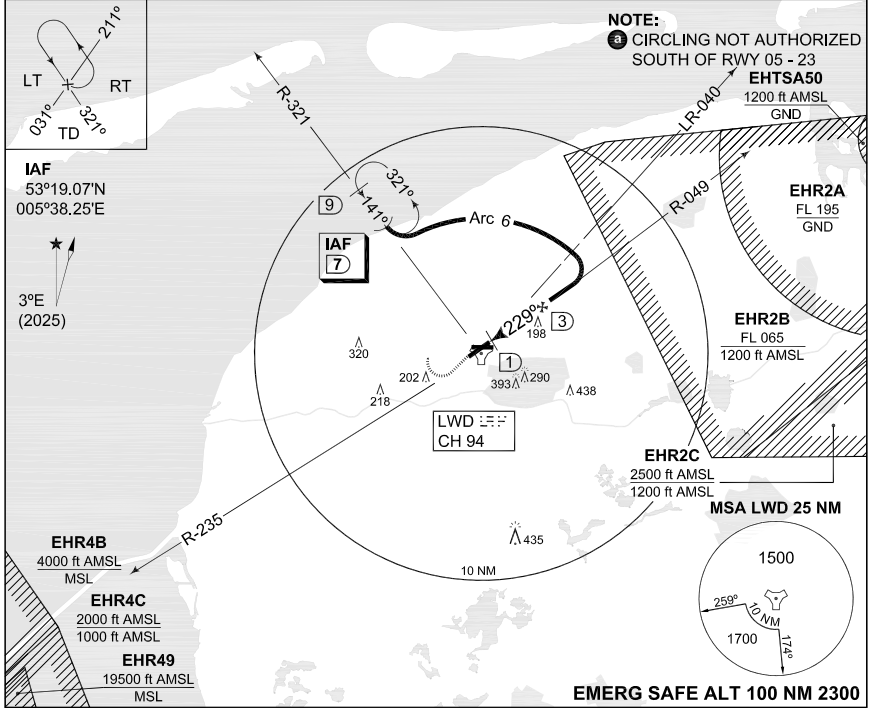

CATEGORY	A
COPTER TACAN 229	380-400 376 (400-0.4/0.8)
CIRCLING ⓐ	500-1900 496 (500-1.9)

CHANGES: EDITORIAL

RNLASF 16 APR 2026

**PANS OPS
INSTRUMENT APPROACH CHART**

**RNP Y RWY 23
LEEWARDEN (EHLW)**

AD ELEV 4

DUTCH MIL 259.250 128.355		RAPCON NORTH 284.475 132.030		LEEWARDEN TWR 344.850 120.705		GND CTL 362.525		
EGNOS CHANNEL 92974 E23A	APP COURSE 233°	FAF ALT 1500 FT	Descent GR 6.5% / 3.72°	MDA 370	DA 204	THR ELEV 4	ALS 720 m	LDA 7863 FT

NOTE:

- a) ALL DISTANCES ARE RELATED TO THRESHOLD
- b) PAPI 3° - NOT ALIGNED WITH INSTRUMENT PROCEDURE VERTICAL PATH

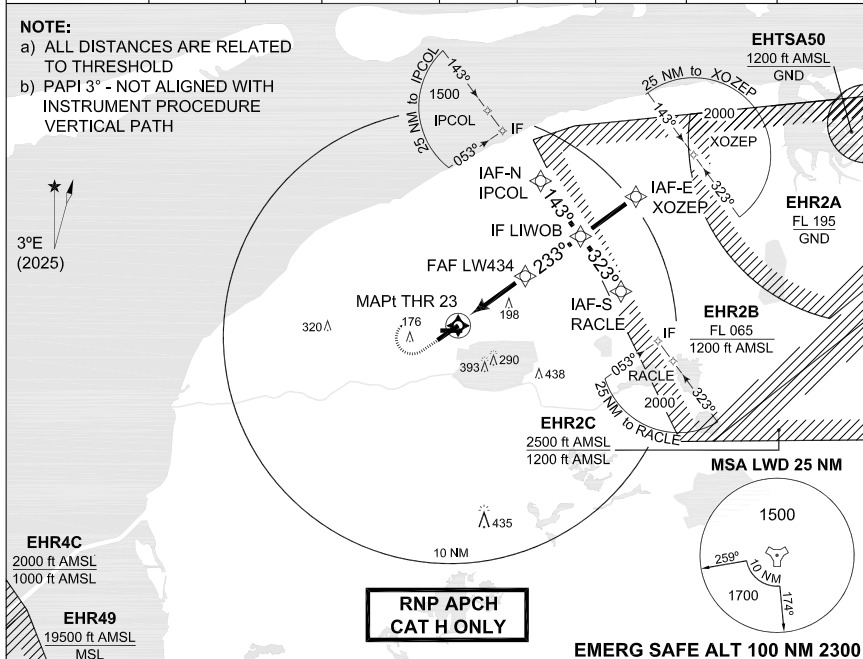

**RNP APCH
CAT H ONLY**

EMERG SAFE ALT 100 NM 2300

DIST THR	1	2	3	GS 3.72°	TA 3000
ALT	450	850	1240	TCH 50	

MISSED APPROACH

At MAPt climb on track 233° to 1500 ft.
At 1200 ft turn right direct to IPCOL.

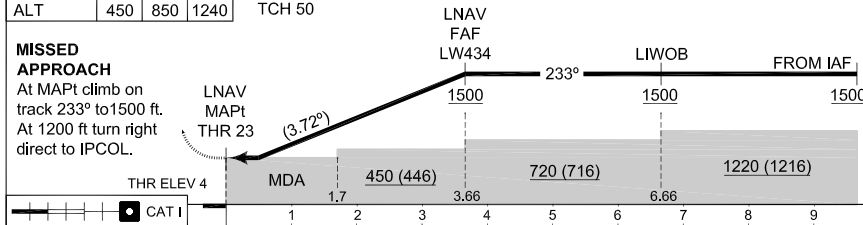

CATEGORY		H					
MIPS	DA(H) LPV	204 -400 200 (200-0.4/1.2)					
	DA(H) LNAV / VNAV	N.A.					
	MDA(H) LNAV	370 -1000 366 (400-1.0/1.7)					
IAF-N	IPCOL	53°20.12'N	005°52.34'E	IF	LIWOBO	53°17.65'N	005°55.18'E
IAF-E	XOZEP	53°19.35'N	005°59.30'E	FAF	LW434	53°15.95'N	005°51.06'E
IAF-S	RACLE	53°15.18'N	005°58.00'E	MAPt	THR23	53°13.88'N	005°46.04'E

RNP Y RWY 23

53°13.52'N
005°45.15'E

LEEWARDEN (EHLW)

CHANGES: EDITORIAL

RNLASF 16 APR 2026

MIPS
INSTRUMENT APPROACH CHART

ILS or LOC RWY 27
LEEUWARDEN (EHLW)

AD ELEV 4

DUTCH MIL 259.250 128.355		RAPCON NORTH 284.475 132.030		LEEUWARDEN TWR 344.850 120.705		GND CTL 362.525		
LOCALIZER / DME LOB 109.750 / CH 34Y		APP COURSE 267°	GS INTCEPT ALT 1200 FT	GS 3°	DA SEE CAT	THR ELEV 3	ALS -	LDA 6561 FT

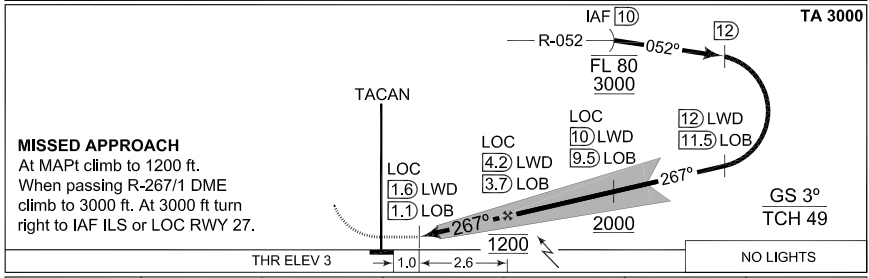
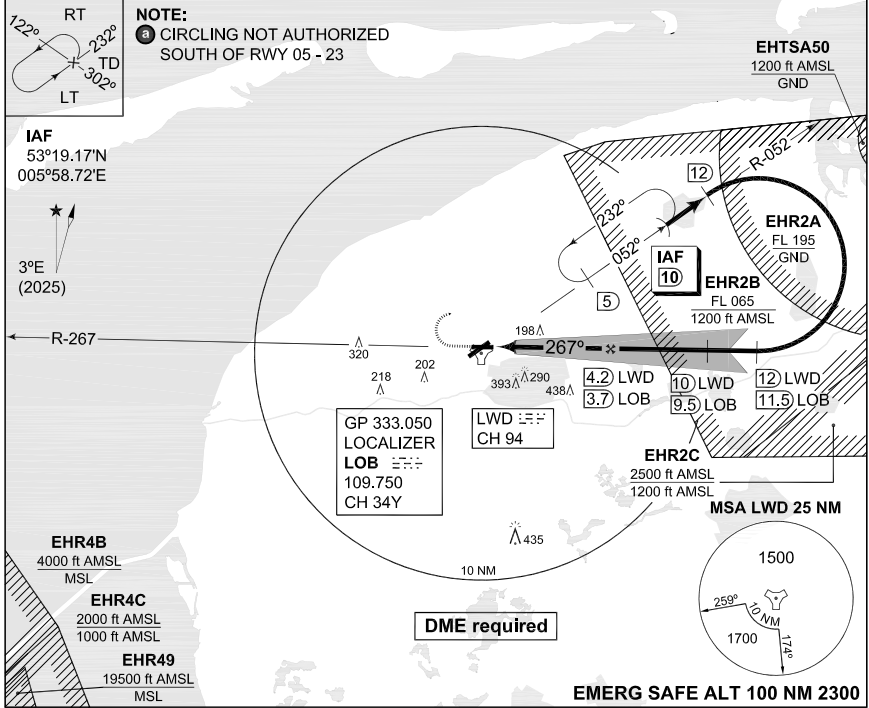

CATEGORY	A	B	C	D	E	H
MINIMA ACCORDING TO PANS-OPS; NOT ACCORDING TO APATC-1						
S-ILS 27	203-1600 200 (200-1.6/1.6)	211-1600 208 (300-1.6/1.6)	220-1600 217 (300-1.6/1.6)	230-1600 227 (300-1.6/1.6)	240-1600 237 (300-1.6/1.6)	203-800 200 (200-0.8/0.8)
S-LOC 27	360-1600 357 (400-1.6/1.6)			360-2000 357 (400-2.0/2.0)		360-800 357 (400-0.8/0.8)
CIRCLING ①	500-1900 496 (500-1.9)	510-2800 506 (600-2.8)	610-3700 606 (700-3.7)	720-4600 716 (800-4.6)	820-6500 816 (900-6.5)	N.A.

ILS or LOC RWY 27 53°13.52'N **LEEUWARDEN (EHLW)**
005°45.15'E

CHANGES: EDITORIAL

RNLASF 16 APR 2026

MIPS
INSTRUMENT APPROACH CHART

HI-TACAN RWY 27
LEEWARDEN (EHLW)

AD ELEV 4

DUTCH MIL 259.250 128.355		RAPCON NORTH 284.475 132.030		LEEWARDEN TWR 344.850 120.705		GND CTL 362.525	
TACAN LWD CH 94	APP COURSE 255°	FAF ALT 1200 FT	Descent GR	MDA 390	THR ELEV 3	ALS -	LDA 6561 FT

NOTE:
ⓐ CIRCLING NOT AUTHORIZED
SOUTH OF RWY 05 - 23

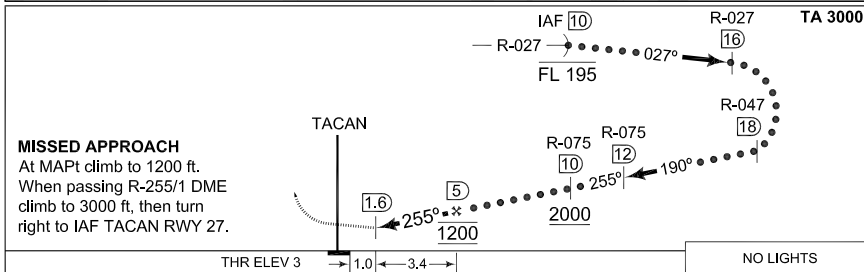
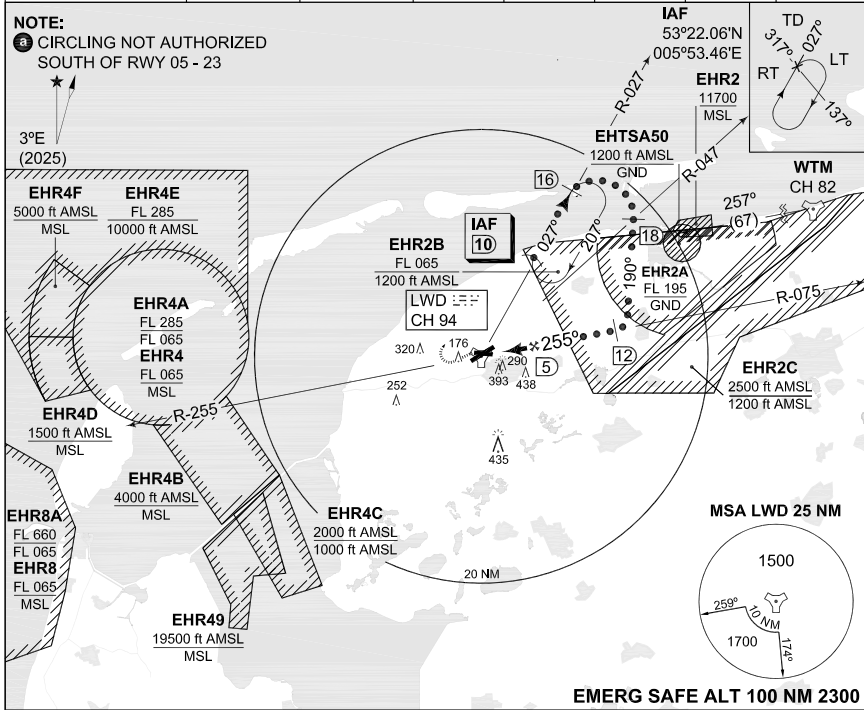

CATEGORY	C	D	E
	MINIMA ACCORDING TO PANS-OPS; NOT ACCORDING TO APATC-1		
S-TACAN 27	390-1600 387 (400-1.6/1.6)	390-2000 387 (400-2.0/2.0)	
CIRCLING ⓐ	610-3700 606 (700-3.7)	720-4600 716 (800-4.6)	820-6500 816 (900-6.5)

HI-TACAN RWY 27

53°13.52'N
005°45.15'E

LEEWARDEN (EHLW)

CHANGES: EDITORIAL

RNLASF 16 APR 2025

MIPS
INSTRUMENT APPROACH CHART

TACAN RWY 27
LEEWARDEN (EHLW)

AD ELEV 4

DUTCH MIL 259.250 128.355		RAPCON NORTH 284.475 132.030		LEEWARDEN TWR 344.850 120.705		GND CTL 362.525	
TACAN LWD CH 94	APP COURSE 255°	FAF ALT 1200 FT	Descent GR	MDA 390	THR ELEV 3	ALS -	LDA 6561 FT

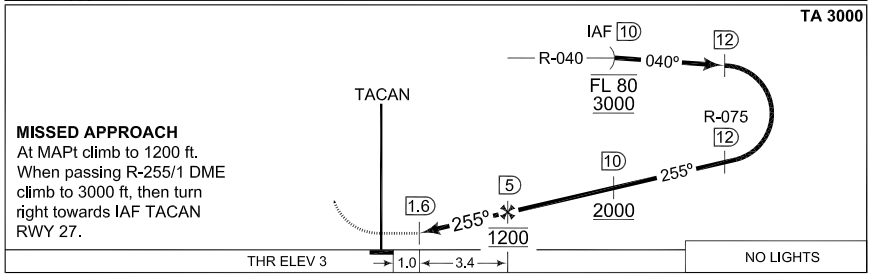
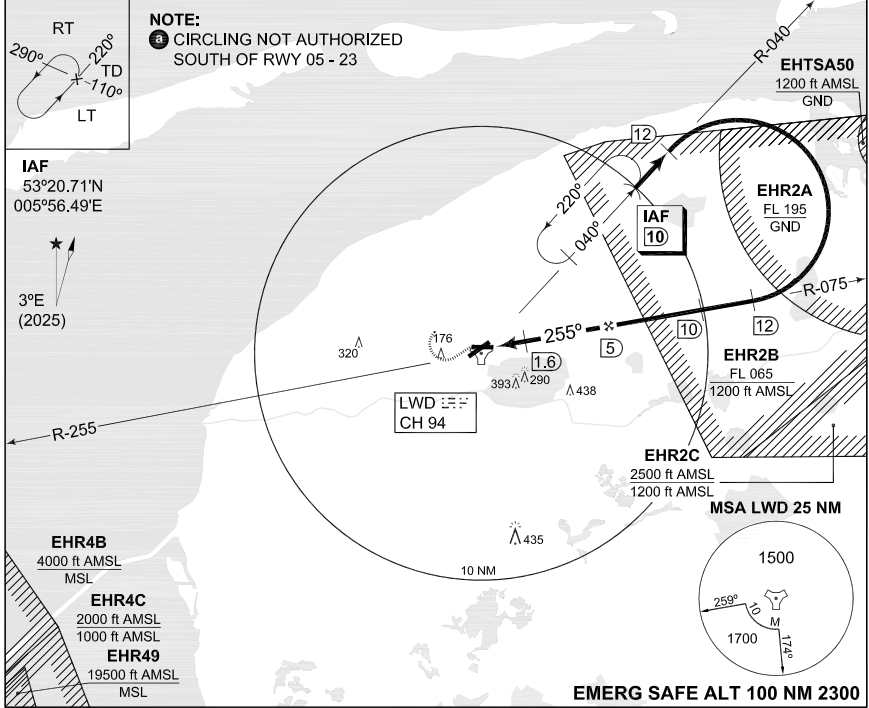

CATEGORY	A	B	C	D	E
MINIMA ACCORDING TO PANS-OPS; NOT ACCORDING TO APATC-1					
S-TACAN 27	390-1600 387 (400-1.6/1.6)			390-2000 387 (400-2.0/2.0)	
CIRCLING ①	500-1900 496 (500-1.9)	510-2800 506 (600-2.8)	610-3700 606 (700-3.7)	720-4600 716 (800-4.6)	820-6500 816 (900-6.5)

TACAN RWY 27

53°13.52'N
005°45.15'E

LEEWARDEN (EHLW)

CHANGES: EDITORIAL
MIPS

RNLASF 16 APR 2025

AERODROME CHART

ODENSE / H C ANDERSEN (EKOD)

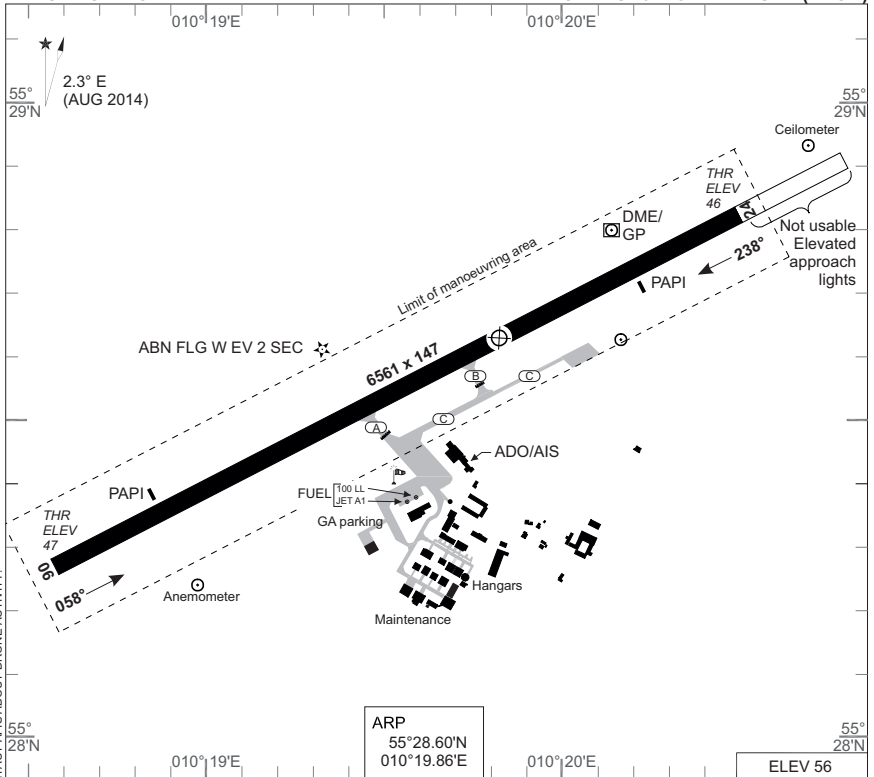

ARP
55°28.60'N
010°19.86'E

ELEV 56

RWY	PCN	DECLARED DISTANCES				PAPI	THR ELEV	THR PSN
		TORA	TODA	ASDA	LDA			
06		6561	6561	6561	6561	3°	47	55°28.25'N 010°18.79'E
A	50 R/D/X/U	3628	3628	3628				
B		2650	2650	2650				
24		6561	6561	6561	6561	3°	46	55°28.79'N 010°20.43'E
B	50 R/D/X/U	3959	3959	3959				
A		2998	2998	2998				

ODENSE INFORMATION 119.530

FLIGHT PROCEDURES

1. IFR Arrival

- 1.1 Aircraft will normally be cleared by ACC KØBENHAVN to OD24F HOLDING.
- 1.2 Navigation aid designated for radio communication failure during IMC for arriving aircraft is NDB FE.

2. IFR Departure

- 2.1 Standard Instrument Departures (SID) have not been established.
- 2.2 Omnidirectional departures:
RWY 06/24: Climb straight ahead to at least 700 FT MSL before turn is commenced.

3. Helicopter

- 3.1 Within AFIS operating hours, contact AFIS before commencing hovertaxi for information regarding drone activity.

	PROC. CRITERIA	RWY	GS	TCH	OTCH	RPI	CAT	MINIMA CRITERIA	MINIMA
PAR	INTENTIONALLY LEFT BLANK								
SRA	INTENTIONALLY LEFT BLANK								

AERODROME CHART

ODENSE / H C ANDERSEN (EKOD)

CHANGES: PARAGRAPH 3. ADDED. BEFORE HOVERTAXI. HELICOPTERS TO CONTACT AFIS ABOUT DRONE ACTIVITY.

AIR COMMAND DENMARK - MIL-AIM.30 OCT 2025

COPENHAGEN CONTROL 360.100 133.150				ODENSE INFORMATION 119.530			
EGNOS CHANNEL 49463 / E06A	APP COURSE 056°	FAF ALT 2000 FT	DESCENT GR 3.0° (5.24%)	DA 297	THR ELEV 47	ALS LENGTH 900 M	LDA 6053 FT

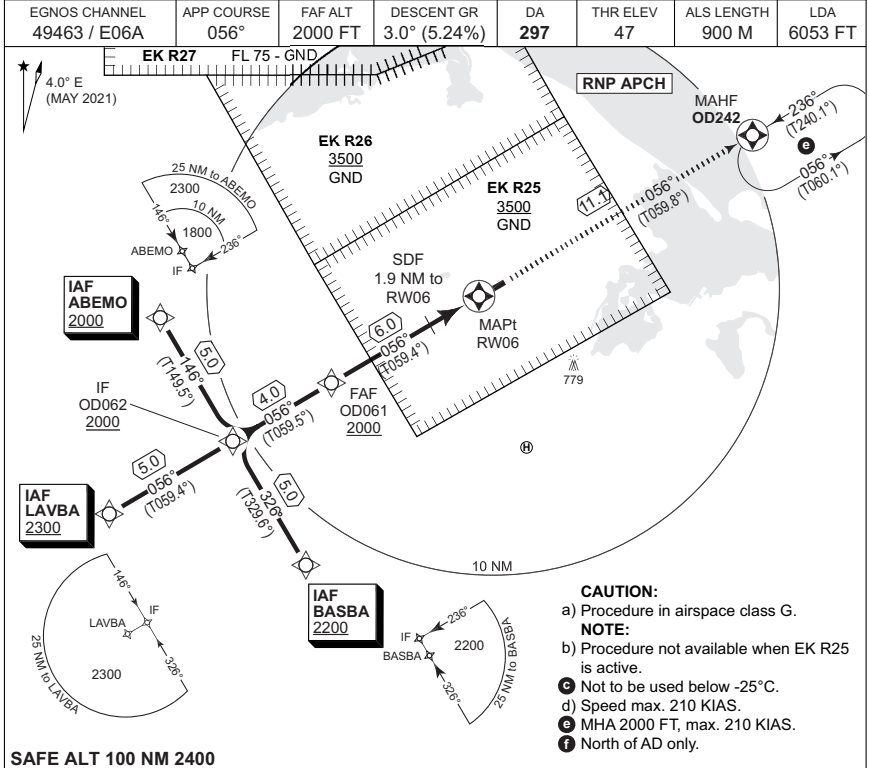

- CAUTION:**
- a) Procedure in airspace class G.
- NOTE:**
- b) Procedure not available when EK R25 is active.
 - c) Not to be used below -25°C.
 - d) Speed max. 210 KIAS.
 - e) MHA 2000 FT, max. 210 KIAS.
 - f) North of AD only.

SAFE ALT 100 NM 2400

TA 3000

CDFA: 3.00° / 5.24%					
DIST TO RW06	5	4	3	2	1
ALT	1690	1370	1050	730	415

MISSED APPROACH
Climb to 2000 ft on track 056° to OD242 to join holding.

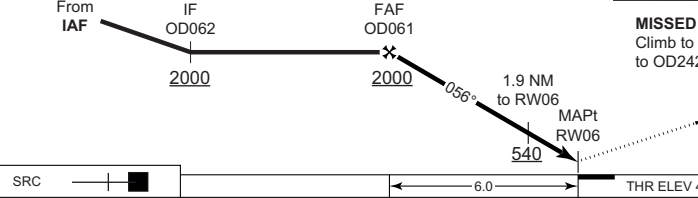

MIPS	CATEGORY	A	B	C	D	E
	LPV	297 - 600 250 (300-0.8/1.3)				
	LNAV/VNAV c	340 - 650 293 (300-0.8/1.4)	350 - 700 303 (400-0.8/1.4)	360 - 700 313 (400-0.8/1.4)	370 - 800 323 (400-0.8/1.5)	380 - 800 333 (400-0.8/1.5)
	LNAV	450 - 1200 403 (500-1.2/1.9)				
CIRCLING f	500 - 1.5 444 (500-1.5)	550 - 1.6 494 (500-1.6)	790 - 2.4 734 (800-2.4)	790 - 3.6 734 (800-3.6)	890 - 3.6 834 (900-3.6)	

EKOD RNP RWY 06 waypoint coordinates:

RWY 06 from ABEMO (Initial LEFT) APPROACH RNP

		CODING	DISPLAY
ABEMO	IAF	55 27 31.03N 009 59 14.01E	55°27.517'N 009°59.233'E
OD062	IF	55 23 13.00N 010 03 41.13E	55°23.217'N 010°03.685'E
OD061	FAF	55 25 14.28N 010 09 44.17E	55°25.238'N 010°09.736'E
RW06	MAPt	55 28 14.82N 010 18 47.44E	55°28.247'N 010°18.791'E
OD242	MAHF	55 33 47.32N 010 35 36.95E	55°33.789'N 010°35.616'E

RWY 06 from BASBA (Initial RIGHT) APPROACH RNP

		CODING	DISPLAY
BASBA	IAF	55 18 54.81N 010 08 07.28E	55°18.913'N 010°08.121'E
OD062	IF	55 23 13.00N 010 03 41.13E	55°23.217'N 010°03.685'E
OD061	FAF	55 25 14.28N 010 09 44.17E	55°25.238'N 010°09.736'E
RW06	MAPt	55 28 14.82N 010 18 47.44E	55°28.247'N 010°18.791'E
OD242	MAHF	55 33 47.32N 010 35 36.95E	55°33.789'N 010°35.616'E

RWY 06 from LAVBA (Initial CENTER) APPROACH RNP

		CODING	DISPLAY
LAVBA	IAF	55 20 40.98N 009 56 08.20E	55°20.683'N 009°56.137'E
OD062	IF	55 23 13.00N 010 03 41.13E	55°23.217'N 010°03.685'E
OD061	FAF	55 25 14.28N 010 09 44.17E	55°25.238'N 010°09.736'E
RW06	MAPt	55 28 14.82N 010 18 47.44E	55°28.247'N 010°18.791'E
OD242	MAHF	55 33 47.32N 010 35 36.95E	55°33.789'N 010°35.616'E

Threshold coordinates RWY 06

		CODING	DISPLAY
RWY 06		55 28 14.82N 010 18 47.44E	55°28.247'N 010°18.791'E

MIPS

INSTRUMENT APPROACH CHART

AD ELEV 56

**ILS or LOC RWY 24
ODENSE / H C ANDERSEN (EKOD)**

COPENHAGEN CONTROL 360.100 133.150				ODENSE INFORMATION 119.530			
---------------------------------------	--	--	--	-------------------------------	--	--	--

LOC/DME OD 108.35/CH20y	APP COURSE 236°	GS INTCP ALT 2000 FT	GS 3.00°	DA 246	THR ELEV 46	ALS LENGTH 900 M	LDA 6053 FT
----------------------------	--------------------	-------------------------	-------------	-----------	----------------	---------------------	----------------

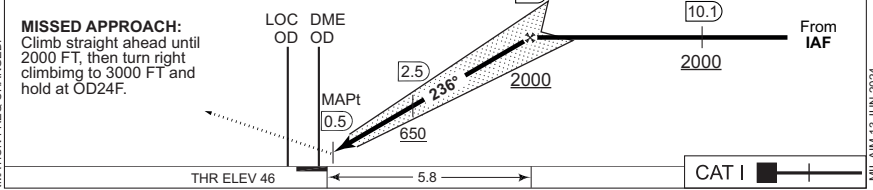
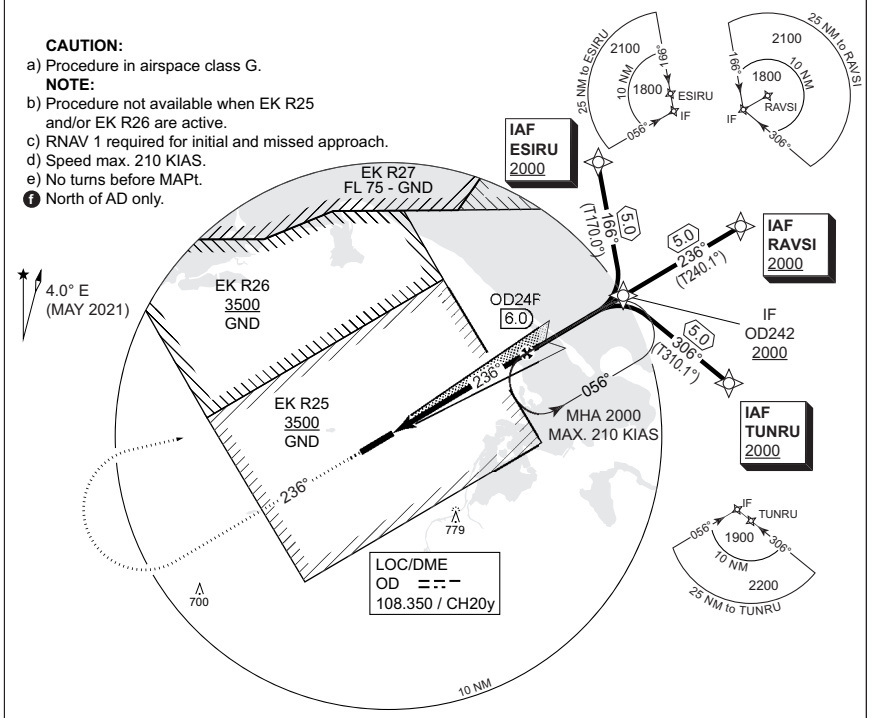

ILS or LOC RWY 24 55°28.60'N **ODENSE / H C ANDERSEN (EKOD)**
010°19.86'E

CHANGES: ODENSE INFORMATION FREQ CHANGED.

AIR COMMAND DENMARK - MIL-AIM 13 JUN 2024

COPENHAGEN CONTROL 360.100 133.150				ODENSE INFORMATION 119.530			
---------------------------------------	--	--	--	-------------------------------	--	--	--

EGNOS CHANNEL 67257 / E24A	APP COURSE 236°	FAF ALT 2000 FT	DESCENT GR 3.0° (5.24%)	DA 296	THR ELEV 46	ALS LENGTH 900 M	LDA 6053 FT
-------------------------------	--------------------	--------------------	----------------------------	-----------	----------------	---------------------	----------------

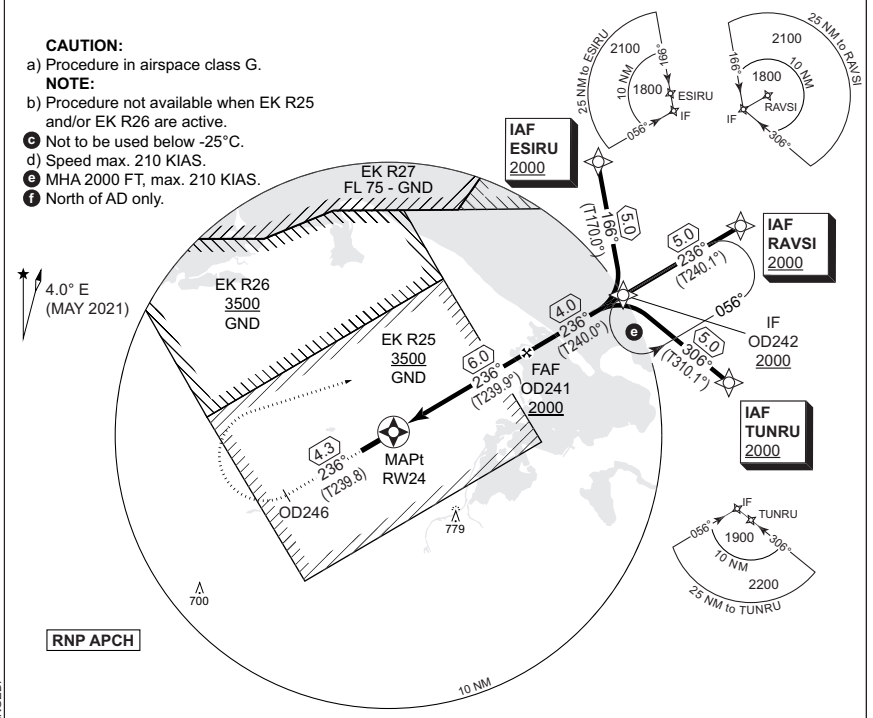

CDFA: 3.00° / 5.24%						TA 3000 GS 3.0° RDH 50
DIST RW24	1	2	3	4	5	
ALT	415	730	1050	1370	1690	

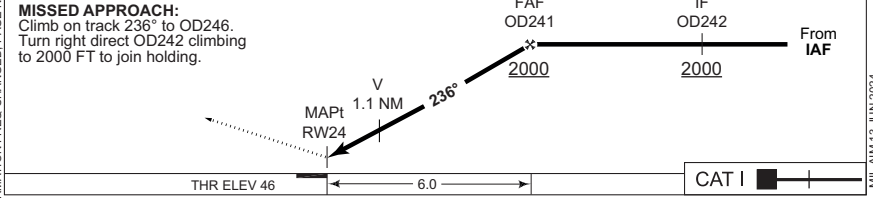

THR ELEV 46	6.0					CAT I
CATEGORY	A	B	C	D	E	
LPV	296 - 600 250 (300-0.8/1.3)					
LNAV/VNAV C	340 - 650 294 (300-0.8/1.4)	350 - 700 304 (400-0.8/1.4)	360 - 700 314 (400-0.8/1.4)	370 - 800 324 (400-0.8/1.5)	380 - 800 334 (400-0.8/1.5)	
LNAV	450 - 1200 404 (500-1.2/1.9)					
CIRCLING f	500 - 1.5 444 (500-1.5)	550 - 1.6 494 (500-1.6)	790 - 2.4 734 (800-2.4)	790 - 3.6 734 (800-3.6)	890 - 3.6 834 (900-3.6)	

CHANGES: ODENSE INFORMATION FREQ CHANGED. PAGE NUMBER CHANGED.

AIR COMMAND DENMARK - MIL_AIM 13 JUN 2024

EKOD RNP RWY 24 waypoint coordinates:

RWY 24 from TUNRU (Initial LEFT) APPROACH RNP

		CODING	DISPLAY
TUNRU	IAF	55 30 34.74N 010 42 21.25E	55°30.579'N 010°42.354'E
OD242	IF	55 33 47.32N 010 35 36.95E	55°33.789'N 010°35.616'E
OD241	FAF	55 31 47.33N 010 29 31.28E	55°31.789'N 010°29.521'E
RW24	MAPt	55 28 47.38N 010 20 25.78E	55°28.790'N 010°20.430'E
OD242	MAHF	55 33 47.32N 010 35 36.95E	55°33.789'N 010°35.616'E

RWY 24 from ESIRU (Initial RIGHT) APPROACH RNP

		CODING	DISPLAY
ESIRU	IAF	55 38 42.17N 010 34 04.84E	55°38.703'N 010°34.081'E
OD242	IF	55 33 47.32N 010 35 36.95E	55°33.789'N 010°35.616'E
OD241	FAF	55 31 47.33N 010 29 31.28E	55°31.789'N 010°29.521'E
RW24	MAPt	55 28 47.38N 010 20 25.78E	55°28.790'N 010°20.430'E
OD242	MAHF	55 33 47.32N 010 35 36.95E	55°33.789'N 010°35.616'E

RWY 24 from RAVSI (Initial CENTER) APPROACH RNP

		CODING	DISPLAY
RAVSI	IAF	55 36 16.88N 010 43 14.91E	55°36.281'N 010°43.249'E
OD242	IF	55 33 47.32N 010 35 36.95E	55°33.789'N 010°35.616'E
OD241	FAF	55 31 47.33N 010 29 31.28E	55°31.789'N 010°29.521'E
RW24	MAPt	55 28 47.38N 010 20 25.78E	55°28.790'N 010°20.430'E
OD242	MAHF	55 33 47.32N 010 35 36.95E	55°33.789'N 010°35.616'E

Threshold coordinates RWY 24

		CODING	DISPLAY
RWY 24		55 28 47.38N 010 20 25.78E	55°28.790'N 010°20.430'E

MIPS

AERODROME CHART

OERLAND(ENOL)

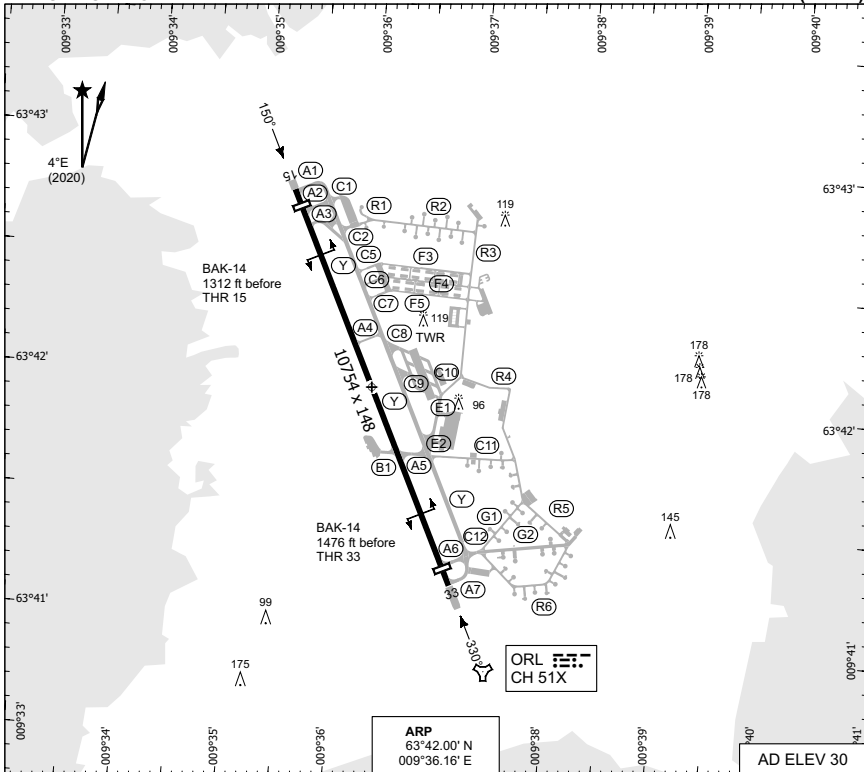

ARP
63°42.00' N
009°36.16' E

AD ELEV 30

RWY	PCN	TORA	ASDA	TODA	LDA	PAPI	THR ELEV	THR PSN
15	120/F/B/W/T	10754	10754	11060	10308	3.0°	20	63°42.73 N - 009°35.37' E
33	120/F/B/W/T	10754	10754	10869	10292	3.3°	30	63°41.28 N - 009°36.96' E

ATIS 119.330
OERLAND TWR 118.705 308.850

PROC. CRITERIA	RWY	GS	TCH	OTCH	RPI	CAT	MINIMA CRITERIA	MINIMA

CHANGE FREQUENCIES

RNAF 25 DEC 2025

AERODROME CHART

OERLAND(ENOL)

MIPS

INSTRUMENT DEPARTURE CHART

AD ELEV 30

HPMA SID RWY 15 / 33
OERLAND(ENOL)

ATIS 119.330		OERLAND TWR 118.705 308.850				OERLAND APP 118.255 268.200				POLARIS CONTROL S 125.705 N 118.555	
RWY	CLIMB AT	GS (kt)	60	120	180	240	300	360	to	reason	
15/33	8.75% 5.0°	V/V (fpm)	532	1064	1595	2127	2659	3190	7000	HPMA	

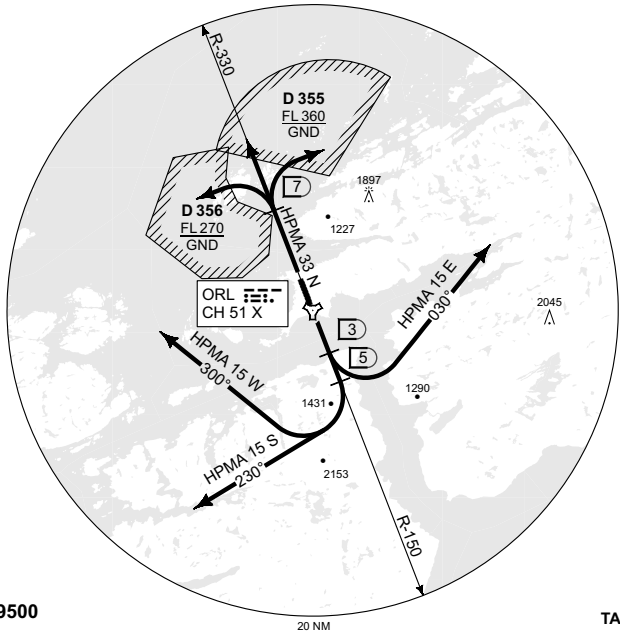

HPMA 15 W	- Climb at 5° on R-150 ORL to DME 5 ORL. Turn right HDG 300°. Climb to 7000 FT. Further turn and climb in accordance with ATC clearance. - Maximum 300 KIAS up to 7000 FT.
HPMA 15 S	- Climb at 5° on R-150 ORL to DME 5 ORL. Turn right HDG 230°. Climb to 7000 FT. Further turn and climb in accordance with ATC clearance. - Maximum 300 KIAS up to 7000 FT.
HPMA 15 E	- Climb at 5° on R-150 ORL to DME 3 ORL. Turn left HDG 030°. Climb to 7000 FT. Further turn and climb in accordance with ATC clearance. - Maximum 300 KIAS up to 7000 FT.
HPMA 33 N	- Climb at 5° on R-330 ORL to DME 7 ORL. Cross DME 7 ORL at 2000 FT or above. Climb to 7000 FT. Further turn and climb in accordance with ATC clearance. - Maximum 300 KIAS up to 7000 FT.

CHANGE: FREQUENCIES: PLAN VIEW OBSTACLES

RNAIF_25 DEC 2025

HPMA SID RWY 15 / 33

63°42.00' N
009°36.16' E

OERLAND(ENOL)

MIPS
INSTRUMENT APPROACH CHART

HPMA ILS or LOC RWY 15
OERLAND(ENOL)

AD ELEV 30

ATIS 119.330	OERLAND ARR 126.205 278.650	OERLAND APP 118.255 268.200	OERLAND TWR 118.705 308.850
LOC/DME OL 109.300 / CH 30X	APP COURSE 150°	GS INTCP ALT 2000	GS 3.0° DA 220 THR ELEV 20
		ALS-LENGTH 720 m	LDA 10308

CAUTION:
● CIRCLING NOT AUTHORIZED
EAST OF RWY 15 / 33.

NOTE:
b) DME REQUIRED.
c) DME FROM ORL UNLESS
INDICATED OTHERWISE.

IAF
63°55.74' N
009°33.87' E

4°E
(2020)

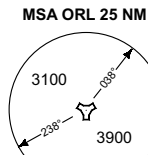
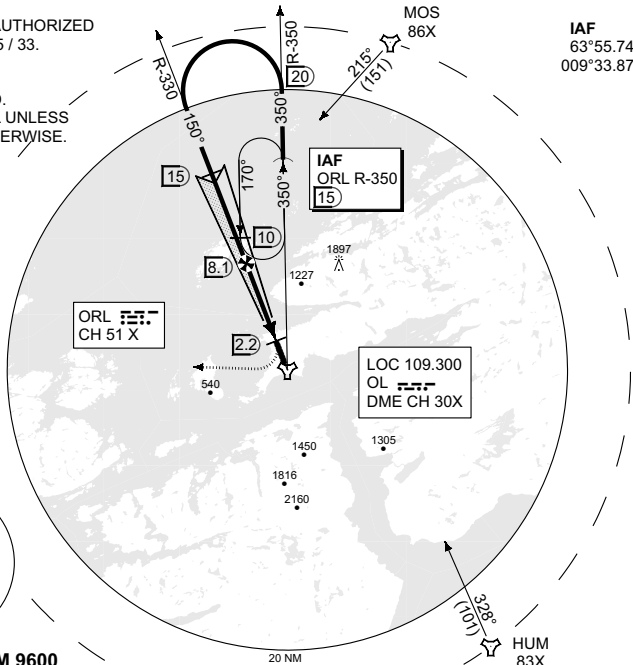

SAFE ALT 100 NM 9600

TA 7000

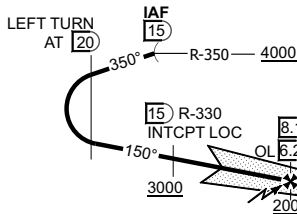

DME ORL (NM)	GP INOP (CDFA 3.0° / 5.24%)							
	8	7	6	5	4	3	2	1
THR 15 (NM)	5.9	4.9	3.9	2.9	1.9	0.9	-	-
ALT	1960	1640	1320	1010	690	370	-	-

TACAN
ORL

MISSED APPROACH
Climb rwy hdg to 500 ft,
then right turn to hdg 263°
climbing to 3000ft.

CAT I

6.1 | THR ELEV 20

CHANGE FREQUENCIES
MIPS

CATEGORY	HPMA
S-ILS	220 - 0.8 200 (200 - 0.8/1.2)
S-LOC	360 - 0.8 340 (400 - 0.8/1.5)
● CIRCLING	630 - 2.7 600 (600 - 2.7)

HPMA ILS or LOC RWY 15

63°42.00' N
009°36.16' E

OERLAND(ENOL)

RNAIF 25 DEC 2025

MIPS

INSTRUMENT APPROACH CHART

AD ELEV 30

**ILS M or LOC M RWY 15
OERLAND(ENOL)**

ATIS 119.330	OERLAND ARR 126.205 278.650	OERLAND APP 118.255 268.200	OERLAND TWR 118.705 308.850
LOC/DME OL 109.300 / CH 30X	APP COURSE 150°	GS INTCP ALT 2000	GS 3.0° DA See CAT THR ELEV 20
	ALS-LENGTH 720 m	LDA 10308	

CAUTION:
● CIRCLING NOT AUTHORIZED EAST OF RWY 15 / 33.

NOTE:
b) DME REQUIRED.
c) DME FROM ORL UNLESS INDICATED OTHERWISE.

IAF 63°55.74' N
009°33.87' E

4°E
(2020)

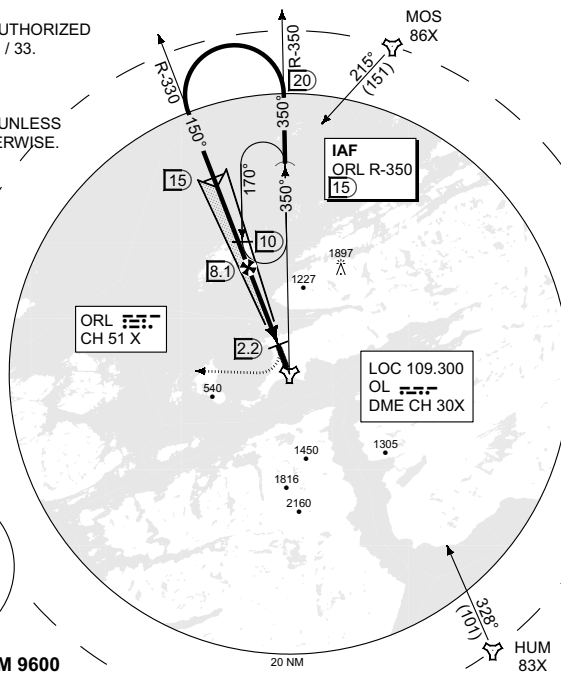

MSA ORL 25 NM

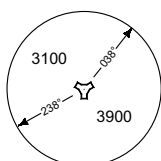

SAFE ALT 100 NM 9600

TA 7000

	GP INOP (CDFA 3.0° / 5.24%)							
DME ORL (NM)	8	7	6	5	4	3	2	1
THR 15 (NM)	5.9	4.9	3.9	2.9	1.9	0.9	-	-
ALT	1960	1640	1320	1010	690	370	-	-

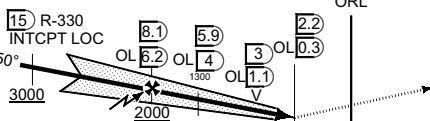
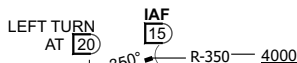

TACAN ORL

MISSED APPROACH
Climb rwy hdg to 400 ft, then right turn (max 200 kts) to hdg 263° climbing to 3000ft.

CAT I

6.1 | THR ELEV 20

CHANGE FREQUENCIES

	A	B	C	D
S-ILS		220 - 0.8 200 (200 - 0.8/1.2)		230 - 0.8 210 (300 - 0.8/1.2)
S-LOC		360 - 0.8 340 (400 - 0.8/1.5)		
● CIRCLING	480 - 2.1 450 (500 - 2.1)	560 - 2.4 530 (600 - 2.4)	990 - 4.5 960 (1000 - 4.5)	1000 - 4.5 970 (1000 - 4.5)

ILS M or LOC M RWY 15

63°42.00' N
009°36.16' E

OERLAND(ENOL)

RNOAF 25 DEC 2025

MIPS INSTRUMENT APPROACH CHART

TACAN RWY 15Y OERLAND (ENOL)

ATIS 119.330		OERLAND ARR 126.205 278.650		AD ELEV 30		OERLAND APP 118.255 268.200		OERLAND TWR 118.705 308.850	
TACAN ORL CH 51X	APP COURSE 152°	FAF ALT 2000	Descent GR 5.3% (3.0°)	MDA 370	THR ELEV 20	ALS N/A	LDA 9022		

- WARNING:**
- a) LANDING THR ON TWY Y, TWY WIDTH 108 FT.
- NOTE:**
- CIRCLING NOT AUTHORIZED NORTHEAST OF RWY 15Y / 33Y.
 - c) MISSED APPROACH MAX 250 KIAS IN TURN.
 - d) FINAL OFFSET 2° NORTH.

IAF
63°55.79' N
009°33.87' E

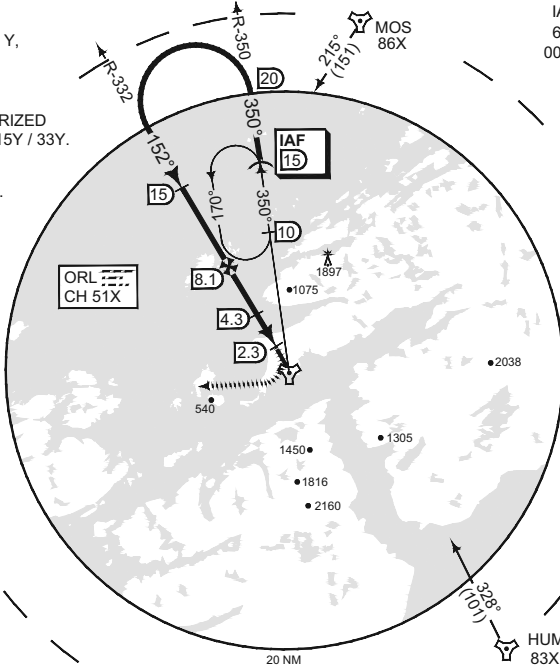

SAFE ALT 100 NM 9500

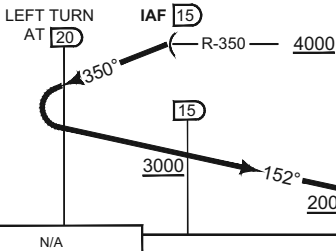

DME ORL	8	7	6	5	4	3
ALT	1970	1660	1340	1020	700	380

TA 7000

MISSED APPROACH
At MAP turn right to HDG 263° climbing to 3000 ft. Max 250 KIAS in turn.

CHANGES: FREQUENCIES	CATEGORY	B	C	D	E
MIPS	S-TAC 15Y	370 - 1.6 350 (400 - 1.6)			
	● CIRCLING	560 - 2.4 530 (600 - 2.4)	990 - 4.5 960 (1000 - 4.5)	990 - 4.5 960 (1000 - 4.5)	1980 - 5.0 1950 (2000 - 5.0)

TACAN RWY 15Y

63°42.00' N
009°36.16' E

OERLAND (ENOL)

MIPS

INSTRUMENT APPROACH CHART

AD ELEV 30

HPMA ILS or LOC RWY 33

OERLAND(ENOL)

ATIS 119.330		OERLAND ARR 126.205 278.650		OERLAND APP 118.255 268.200		OERLAND TWR 118.705 308.850		
ILS/DME ON 108.300 / CH 20X		APP COURSE 330°	GS INTCP ALT 2500	GS 3.3°	DA 230	THR ELEV 30	ALS-LENGTH 450 m	LDA 10292

CAUTION:

1. CIRCLING NOT AUTHORIZED EAST OF RWY 15/33.

NOTE:

c) DME REQUIRED.
d) DME FROM ORL UNLESS INDICATED OTHERWISE.

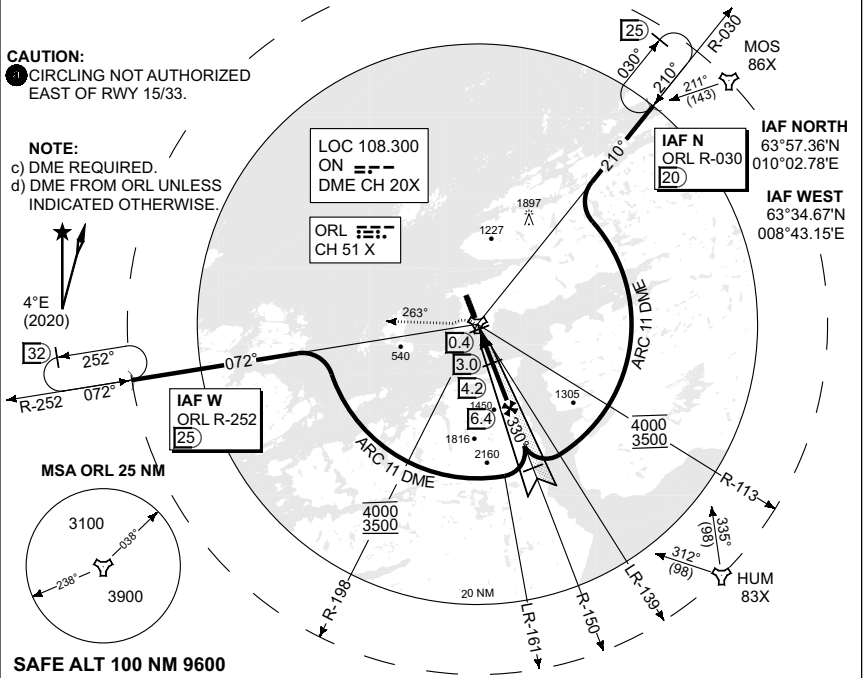

GP INOP (CDFA 3.3° / 5.77%)

DME ORL (NM)	1	2	3	4	5	6	7	8
THR 33 (NM)	1.5	2.5	3.5	4.5	5.5	6.5	-	-
ALT	600	950	1300	1650	2000	2350	-	-

TA 7000

MISSED APPROACH:

Climb RWY HDG to 500 ft then turn left to HDG 263° climbing to 3000 ft.

NOTE:

No turn before 0.4 ORL.

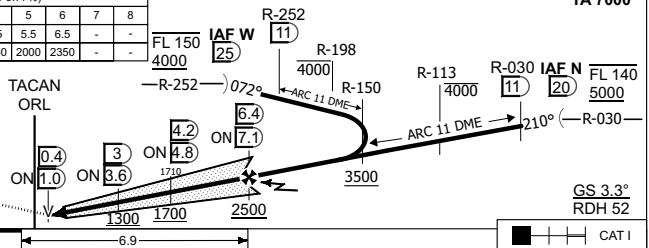

CHANGE FREQUENCIES

MIPS	CATEGORY	HPMA
	S-ILS	230 - 0.8 200 (200 - 0.8/1.2)
	S-LOC	380 - 1.2 350 (400 - 1.2/1.5)
1. CIRCLING		630 - 3.2 600 (600 - 3.2)

HPMA ILS or LOC RWY 33

63°42.00' N
009°36.16' E

OERLAND(ENOL)

RNAIF 25 DEC 2025

MIPS
INSTRUMENT APPROACH CHART

ILS M or LOC M RWY 33
OERLAND (ENOL)

AD ELEV 30

ATIS 119.330	OERLAND ARR 126.205 278.650	OERLAND APP 118.255 268.200	OERLAND TWR 118.705 308.850
ILS/DME ON 108.300 / CH 20X	APP COURSE 330°	GS INTCP ALT 2500	GS 3.3°
		DA See CAT	THR ELEV 30
		ALS-LENGTH 450 m	LDA 10292

CAUTION:
① CIRCLING NOT AUTHORIZED EAST OF RWY 15/33.

NOTE:
b) DME REQUIRED.
c) DME FROM ORL UNLESS INDICATED OTHERWISE.

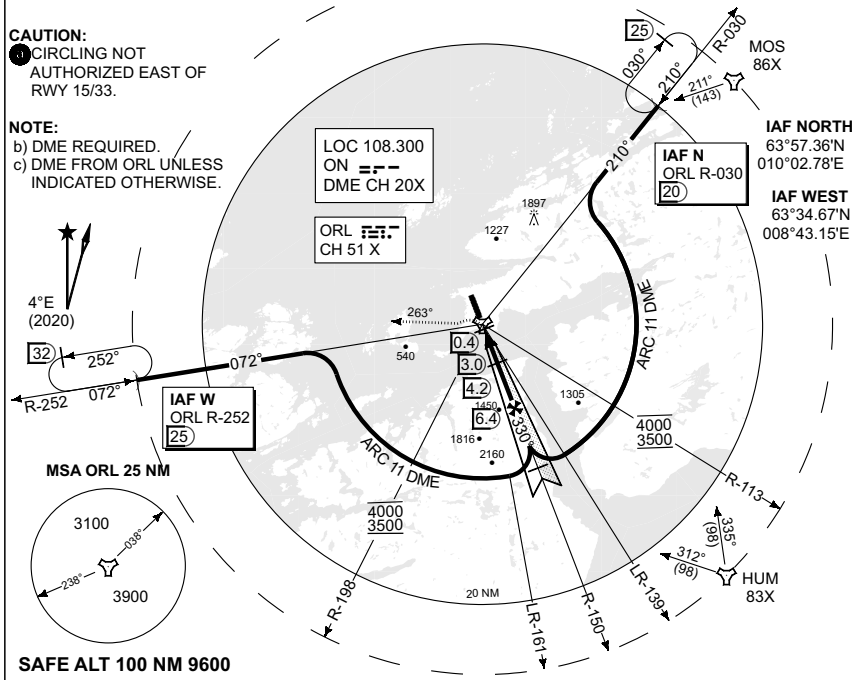

GP INOP (CDFA 3.3° / 5.77%)

DME ORL (NM)	1	2	3	4	5	6	7	8
THR 33 (NM)	1.5	2.5	3.5	4.5	5.5	6.5	-	-
ALT	600	950	1300	1650	2000	2350	-	-



MISSED APPROACH:
Climb RWY HDG to 500 ft then turn left to HDG 263° climbing to 3000 ft.

MIPS

INSTRUMENT APPROACH CHART

AD ELEV 30

**TACAN RWY 33
OERLAND(ENOL)**

ATIS 119.330		OERLAND ARR 126.205 278.650		OERLAND APP 118.255 268.200		OERLAND TWR 118.705 308.850	
TACAN ORL CH 51X	APP COURSE 330°	FAF ALT 2100	Descent GR 6.1% (3.5°)	MDA 440	THR ELEV 30	ALS-LENGTH 450 m	LDA 10292

CAUTION:

● CIRCLING NOT AUTHORIZED EAST OF RWY 15/33.

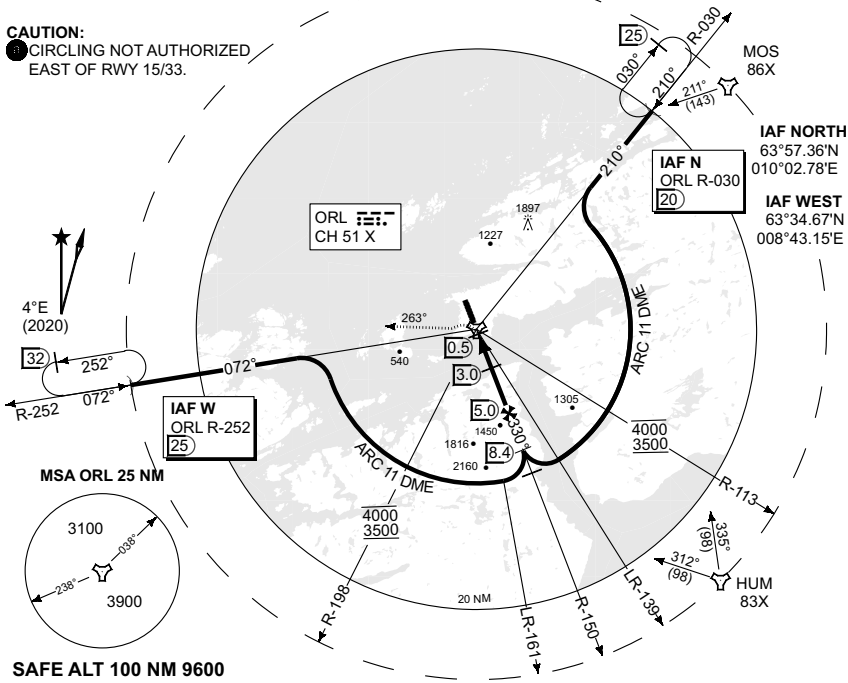

CDFA 6.1% / 3.5°								
DME ORL (NM)	1	2	3	4	5	6	7	8
THR 33 (NM)	1.5	2.5	3.5	4.5	5.5	-	-	-
ALT	630	1000	1370	1740	2100	-	-	-

TA 7000

MISSED APPROACH:

At Mapt turn left to HDG 263° climbing to 3000 ft.

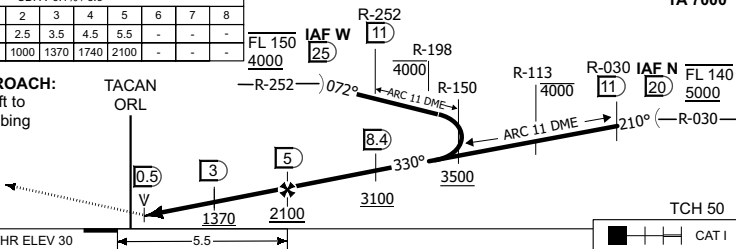

CATEGORY	B	C	D	E
S-TAC			440 - 1.5 410 (500 - 1.5/1.9)	
● CIRCLING	560 - 2.4 530 (600 - 2.4)	990 - 4.5 960 (1000 - 4.5)	1000 - 4.5 970 (1000 - 4.5)	1980 - 5.0 1950 (2000 - 5.0)

TACAN RWY 33

63°42.00' N
009°36.16' E

OERLAND(ENOL)

CHANGE FREQUENCIES: EDITORIALS.

RNO/AF 25 DEC 2025

MIPS INSTRUMENT APPROACH CHART

TACAN RWY 33Y OERLAND (ENOL)

ATIS 119.330		OERLAND ARR 126.205 278.650		OERLAND APP 118.255 268.200		OERLAND TWR 118.705 308.850	
TACAN ORL CH 51X	APP COURSE 319°	FAF ALT 2100	Descent GR 6.1% (3.5°)	MDA SEE CAT	THR ELEV 29	ALS LENGTH N/A	LDA 9022

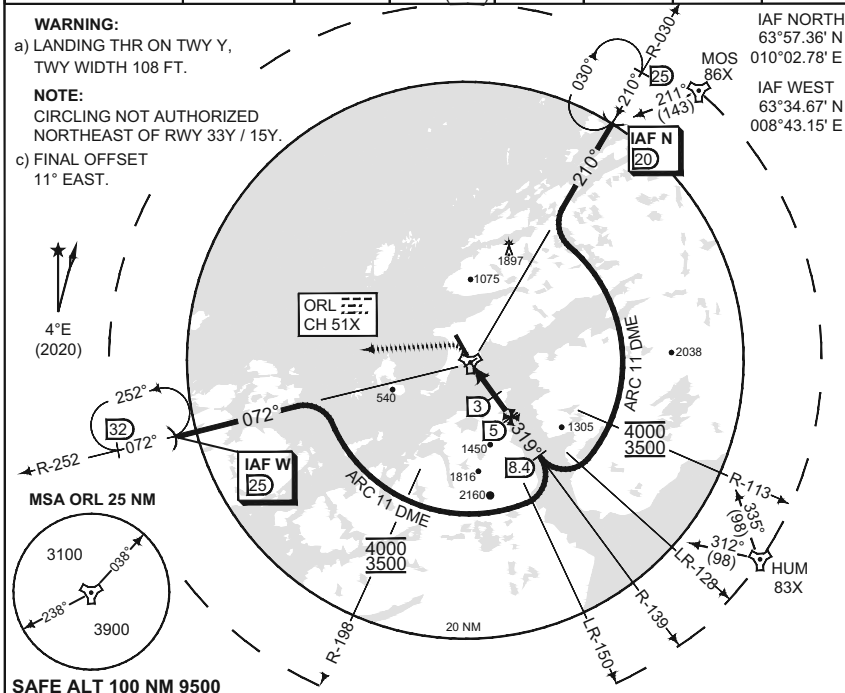

DME ORL	1	2	3	4	5	TA 7000
ALT	640	1010	1370	1740	2100	

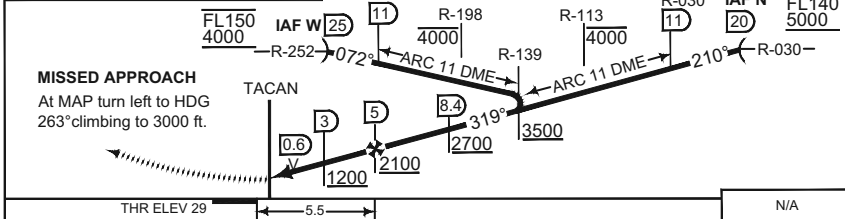

CHANGES: FREQUENCIES	CATEGORY	B	C	D	E
MIPS	S-TAC 33Y		490 - 2.2	461 (500 - 2.2)	510 - 2.3 481 (500 - 2.3)
	CIRCLING	560 - 2.4 530 (600 - 2.4)	990 - 4.5	960 (1000 - 4.5)	1980 - 5.0 1950 (2000 - 5.0)

TACAN RWY 33Y

63°42.00' N
009°36.16' E

OERLAND (ENOL)

RNOAF 25 DEC 2025

AERODROME CHART

ROENNE (EKRN)

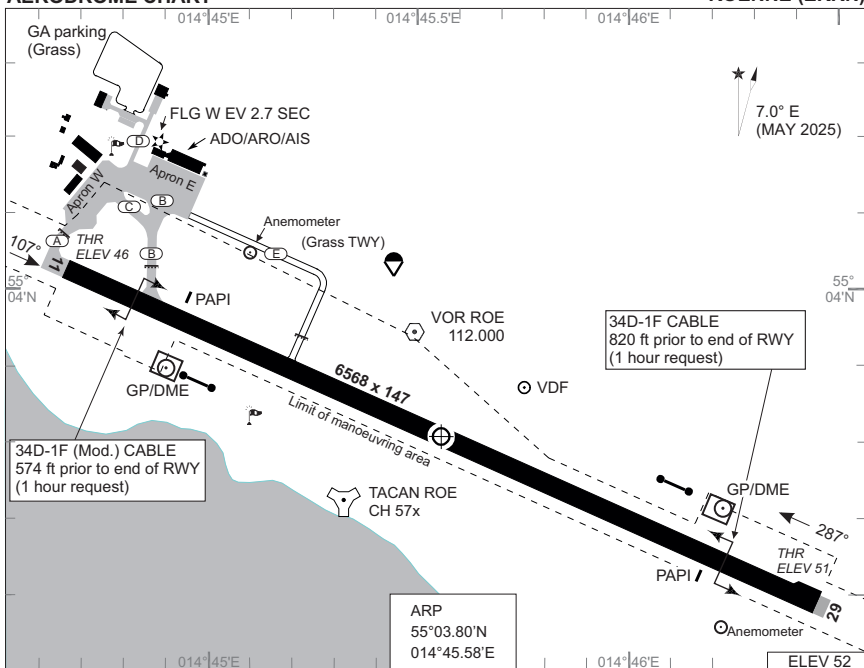

RWY	PCN	DECLARED DISTANCES						THR ELEV	THR PSN	
		PSN	TORA	TODA	ASDA	LDA	PAPI			
11	38 F/B/X/T	THR				6568	3°	46	55°04.01'N	014°44.71'E
		A	6568	6568	6568					
		B	5928	5928	5928					
29		THR	6568	6568	6568	6568	3°	51	55°03.58'N	014°46.43'E

ROENNE TWR 118.330 (VDF) 257.800

Flight Procedures

1. IFR Arrival

- 1.1 Aircraft will normally be cleared by SWEDEN CONTROL to ROE VOR.
- 1.2 Navigation aid designated for radio communication failure during IMC for arriving aircraft is NDB FAU.

2. IFR Departure

- 2.1 Standard Instrument Departures (SID) have not been established.
- 2.2 Omnidirectional departures
- RWY 11: Climb straight ahead to at least 700 FT MSL before turn is commenced.
- RWY 29: Climb straight ahead to at least 500 FT MSL before turn is commenced. Procedure design gradient 4.5% up to 800 FT MSL, due to cranes 525 FT, 2.1 NM NW from THR.

CHANGES, VAR AND RWY DIRECTION CHANGED.

AIR COMMAND DENMARK - MIL_AIM 19 FEB 2025

	PROC. CRITERIA	RWY	GS	TCH	OTCH	RPI	CAT	MINIMA CRITERIA	MINIMA
PAR	NOT AVAILABLE								
SRA	NOT AVAILABLE								

AERODROME CHART

ROENNE (EKRN)

MIPS
INSTRUMENT APPROACH CHART

AD ELEV 52

ILS or LOC RWY 11
ROENNE (EKRN)

SWEDEN CONTROL 134.980 128.180			ROENNE TOWER 257.800 118.330					
LOC/DME IAR 109.350/CH30y	TACAN ROE 112.00/CH57x	APP COURSE 107°	GS INCP TALT 2000 FT	GS 3.00°	DA See CAT	THR 46	ALS 600 M	LDA 6568 FT

DME REQUIRED

RNAV 1 REQUIRED

NOTE:

- a) Max. 240 KIAS.
- b) Circling SW of AD only.
- c) Max. 200 KIAS.
- d) RNAV 1 required for initial and missed approach.

POWQU HOLDING

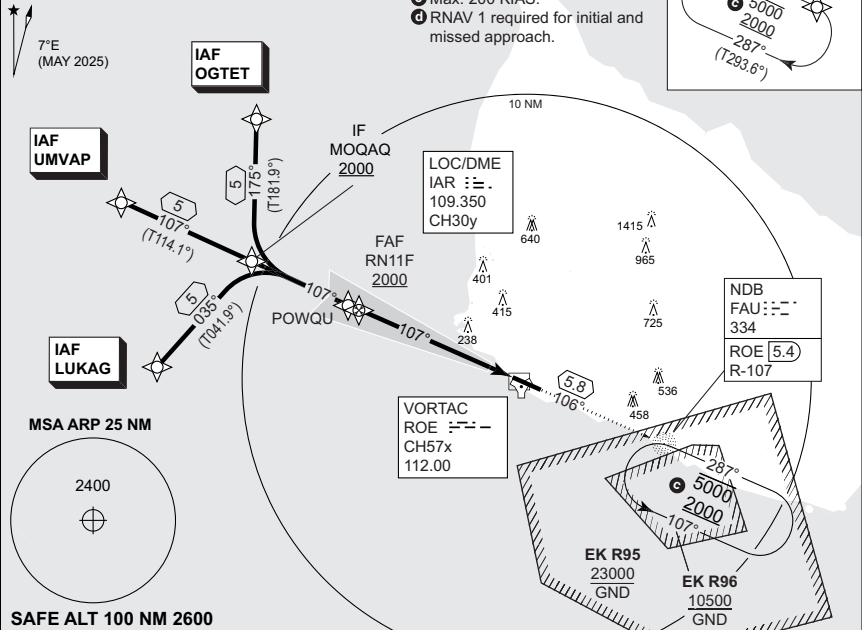
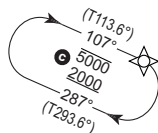

TA 5000
GS 3.00°
RDH 55

CDFA: 3.00° / 5.24%

DME ROE	6.3	5.3	4.3	3.3	2.3
DME IAR	6	5	4	3	2
ALT	1980	1660	1340	1010	690

NDB
FAU
ROE **5.4**

MISSED APPROACH:
Climb straight ahead to
FAU and hold (MHA 2000)

CHANGES: DME ADDED TO NDB FAU IN PROFILE VIEW...

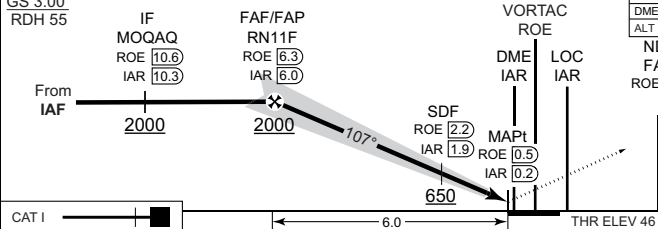

CAT I 6.0 THR ELEV 46

CATEGORY	A	B	C	D	E
S-ILS 11			246 - 750 200 (200-0.8/1.2)		
S-LOC 11			380 - 1100 328 (400-1.1/1.5)		
CIRCLING	470 - 1.5 418 (500-1.5)	630 - 1.6 578 (600-1.6)	730 - 2.4 678 (700-2.4)	750 - 3.6 698 (700-3.6)	840 - 3.6 788 (800-3.6)

ILS or LOC RWY 11

55°03.80'N
014°45.58'E

ROENNE (EKRN)

AIR COMMAND DENMARK - MIL-AIM 16 APR 2026

MIPS

INSTRUMENT APPROACH CHART

AD ELEV 52

**ILS or LOC RWY 29
ROENNE (EKRN)**

SWEDEN CONTROL 134.980 128.180				ROENNE TOWER 257.800 118.330				
LOC/DME IRE 110.30/CH40x	VORTAC ROE 112.00/CH 57x	APP COURSE 287°	GS INTCP ALT 2000 FT	GS 3.0°	DA 251	THR 51	ALS length 900 M	LDA 6568 FT

NOTES:

- a** CIRCLING SOUTH OF AERODROME ONLY
- b** BASE TURN FAU OUTBOUND:
CAT. A-B 135°
CAT. C-E 151° - MAX SPEED 220 KIAS

DME REQUIRED

7.0°E
(MAY 2025)

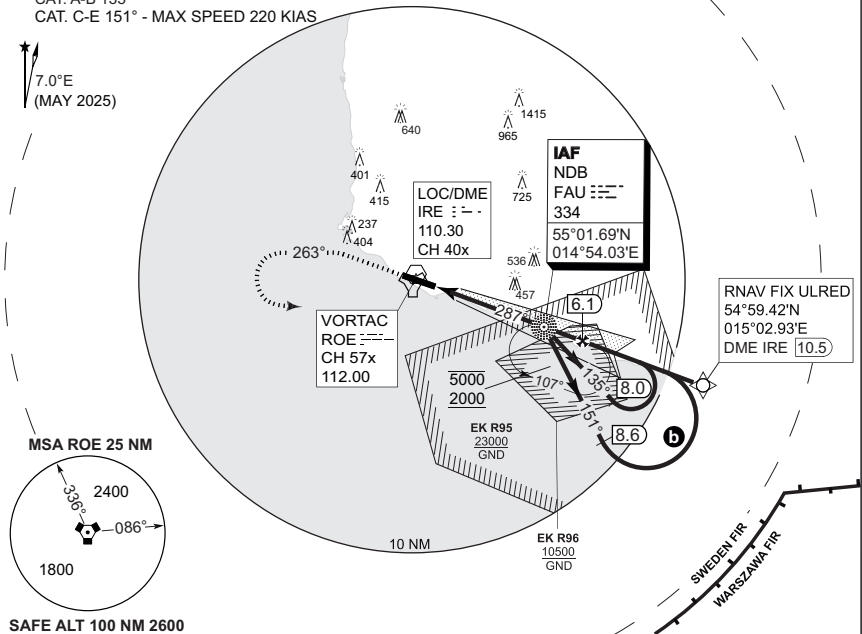

SAFE ALT 100 NM 2600

LOC	CDFA	3.00° / 5.2%			
DME IRE	2	3	4	5	6
DIST THR	1.8	2.8	3.8	4.8	5.8
ALT	690	1010	1330	1640	1960

MISSED APPROACH

Climb to minimum 700 ft, turn left and climb on track 263° to 2000 ft. Turn left to FAU NDB (ROE R-107, IRE DME 4.9) and hold.

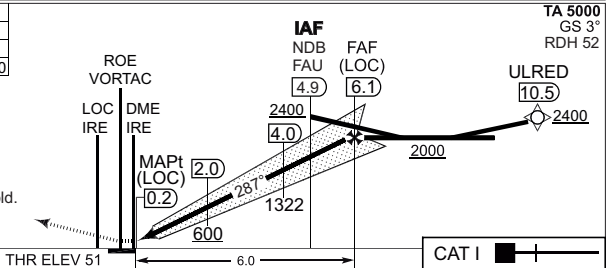

CATEGORY	A	B	C	D	E
S-ILS 29			251 - 550 200 (200-0.8/1.2)		
S-LOC 29			400 - 900 349 (400-0.9/1.6)		
CIRCLING a	500 - 1.5 450 (500-1.5)	700 - 2.3 650 (700-2.3)	800 - 2.7 750 (800-2.7)	800 - 3.6 750 (800-3.6)	900 - 3.6 850 (900-3.6)

CHANGES: VAR. DIRECTIONS AND HOLDING ALTITUDE CHANGED.

ILS or LOC RWY 29

55 03.80'N
014 45.58'E

ROENNE (EKRN)

AIR COMMAND DENMARK - MIL_AIM_19 FEB 2025

AERODROME CHART

ROSKILDE (EKRK)

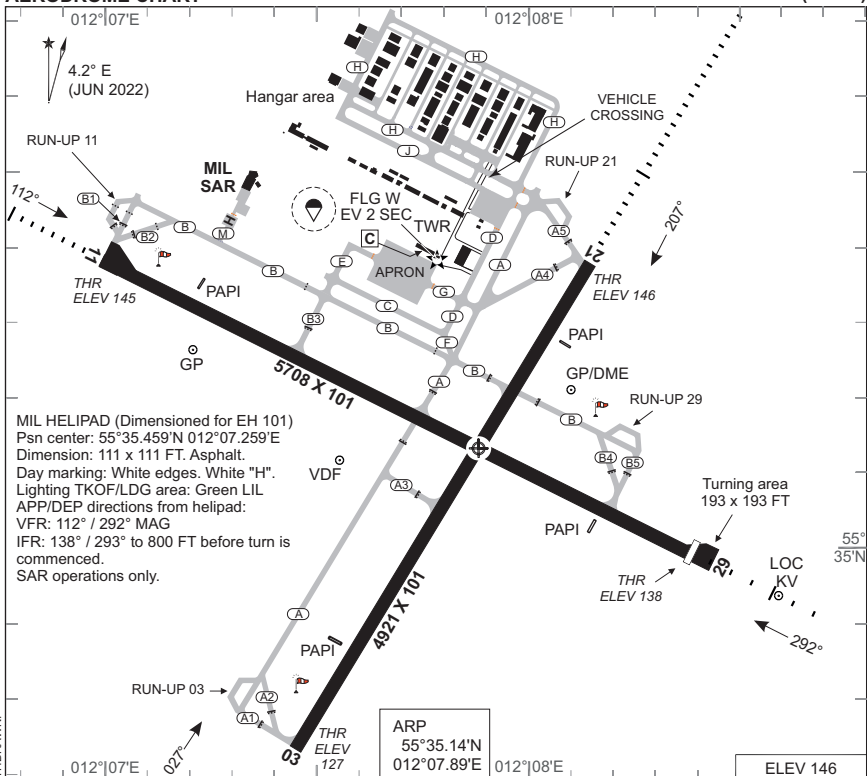

RWY	PCN	DECLARED DISTANCES					THR ELEV	RWY LIGHTING					THRPSN	
		PSN	TORA	TODA	ASDA	LDA		THR	PAPI	TDZ	CL	EDGE		END
03	30F/C/X/T	A1/2	4921	4921	4921	4921	127	LIH	3°			LIH	LIH	55°34.70'N 012°07.43'E
		A3	2483	2483	2483									
		A4/5	4921	4921	4921	4921	146	LIH	3°			LIH	LIH	55°35.40'N 012°08.16'E
11	36F/C/X/T	B	3664	3664	3664									
		B1/2	5708	5708	5902	5708	145	LIH	3°			LIH	LIH	55°35.40'N 012°06.94'E
		B3	3864	3864	4058									
		A	2673	2673	2867									
29			5902	5902	5902	5708	138	LIH	3°			LIH	LIH	55°34.98'N 012°08.42'E
		B4/5	4921	4921	4921									
		A	3070	3070	3070									

ROSKILDE ATIS 123.805
 ROSKILDE TWR 118.905 (119.655)
 ROSKILDE APP 125.530
 ROSKILDE HANDLING 131.555 (Handling, FPL etc.)
 COPENHAGEN INFORMATION 127.080 (Civil)

TAXI REGULATIONS
 Incoming traffic shall taxi via TWY C and TWY D, and outgoing traffic via TWY A and TWY B unless otherwise instructed by ATC.

CHANGES: ATS SERVICE BOUNDARY ADDED. LIMIT OF MANEUVERING AREA WITHDRAWN.

AIR COMMAND DENMARK - MIL-AIM 19 FEB 2026

AERODROME CHART

ROSKILDE (EKRK)

MIPS

INSTRUMENT APPROACH CHART

AD ELEV 146

**ILS or LOC RWY 11 (CAT A-B)
ROSkilde (EKRK)**

COPENHAGEN APPROACH 119.805		ROSKILDE ATIS 123.805		ROSKILDE APPROACH 125.530		ROSKILDE TOWER 118.905 119.655	
LOC/DME KV 111.50 CH 52x	APP COURSE 112°	GS INTCP ALT 2000 FT	GS 3.00°	DA 345	THR ELEV 145 FT	ALS LENGTH 900 M	LDA 5708 FT

DME REQUIRED

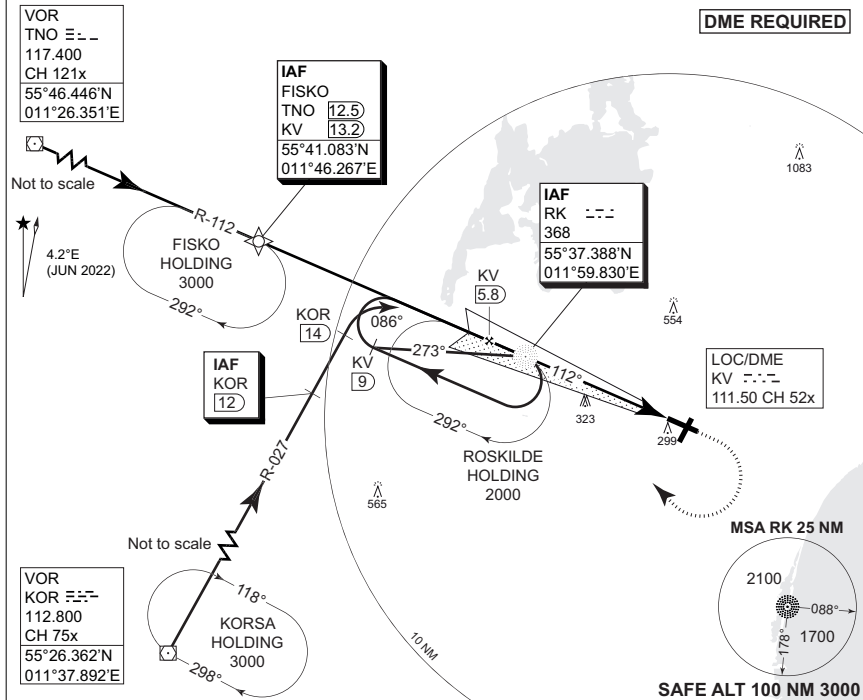

TA 5000 GS 3.0° RDH 52	IAF FSKO or KOR 12	FAF KV 5.8	KV 5.0	IAF NDB RK	V KV 1.2	LOC ONLY CDFA 3.0° / 5.3%					
						DME KV	5	4	3	2	1
						DIST TO THR	4.8	3.8	2.8	1.8	0.8
ALT						1740	1420	1100	780	460	

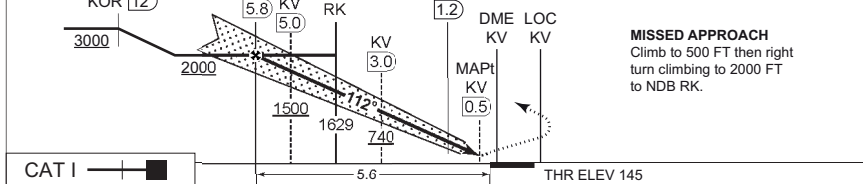

MIPS	CATEGORY	A	B
	S-ILS 11	345 - 550 200 (200-0.8/1.2)	
	S-LOC 11	520 - 1000 375 (400-1.0/1.7)	
	CIRCLING	610 - 1.5 464 (500-1.5)	850 - 1.6 704 (800-1.6)

ILS or LOC RWY 11 (CAT A-B)

55°35.13'N
012°07.89'E

ROSkilde (EKRK)

CHANGES: ATC FREQ CHG.

AIR COMMAND DENMARK - MIL_AIM 28 DEC 2023

MIPS

INSTRUMENT APPROACH CHART

AD ELEV 146

**ILS or LOC RWY 11 (CAT C-E)
ROSكيلDE (EKRR)**

COPENHAGEN APPROACH 119.805		ROSKILDE ATIS 123.805		ROSKILDE APPROACH 125.530		ROSKILDE TOWER 118.905 119.655	
LOC/DME KV 111.50 CH 52x	APP COURSE 112°	GS INTCP ALT 2000 FT	GS 3.00°	DA SEE CAT	THR ELEV 145 FT	ALS LENGTH 900 M	LDA 5708 FT

DME REQUIRED

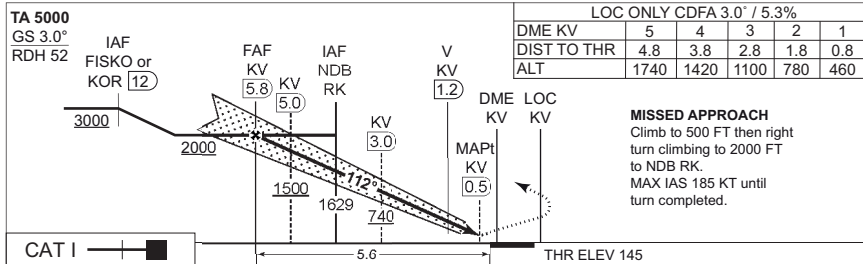
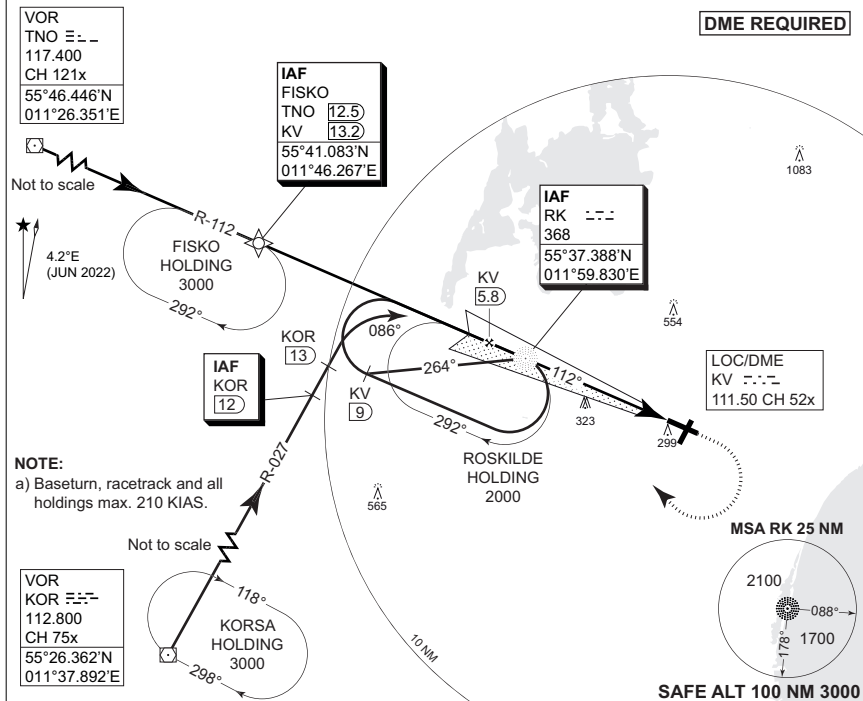

CHANGES: ATC FREQ CHG.	CATEGORY	C	D	E
MIPS	S-ILS 11 (MACG 2.5%)	439 - 650 294 (300-0.8/1.4)	449 - 700 304 (400-0.8/1.4)	467 - 800 322 (400-0.8/1.5)
	S-ILS 11 (MACG 5.0%)		345 - 550 200 (200-0.8/1.2)	
	S-LOC 11		520 - 1000 375 (400-1.0/1.7)	
	CIRCLING	950 - 2400 804 (900-2.4)	950 - 3600 804 (900-3.6)	1050 - 3600 904 (1000-3.6)

ILS or LOC RWY 11 (CAT C-E)

55°35.13'N
012°07.89'E

ROSكيلDE (EKRR)

MIPS

INSTRUMENT APPROACH CHART

AD ELEV 146

**NDB RWY 11 (CAT A-B)
ROSKILDE (EKRK)**

COPENHAGEN APPROACH 119.805		ROSKILDE ATIS 123.805		ROSKILDE APPROACH 125.530		ROSKILDE TOWER 118.905 119.655	
NDB RK 368	DME KV CH 52x	APP COURSE 112°	FAF ALT 1700 FT	DESCENT GR 3.2° (5.51%)	MDA 740	THR ELEV 145 FT	ALS LENGTH 900 M LDA 5708 FT

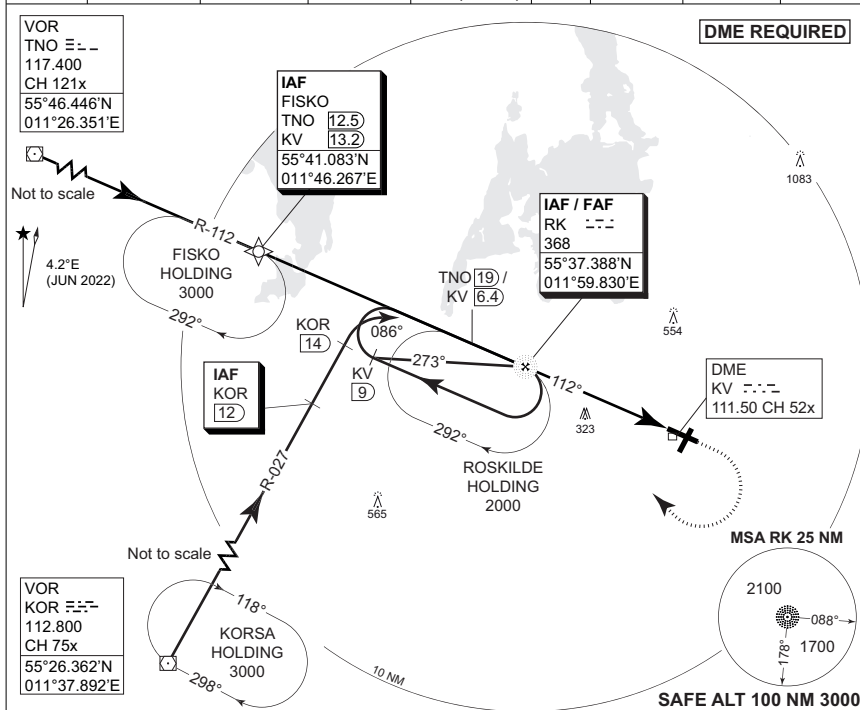

DME REQUIRED

SAFE ALT 100 NM 3000

TA 5000	IAF FSKO or KOR (12)	TNO KV (19) / (6.4)	IAF NDB RK	V KV (1.8)	DME KV														
	3000	2000	1700	MAPt KV (1.0)															
	<table border="1"> <tr> <td colspan="3">CDFA 3.2° / 5.51%</td> </tr> <tr> <td>DME KV</td> <td>4</td> <td>3</td> <td>2</td> </tr> <tr> <td>DIST TO THR</td> <td>3.8</td> <td>2.8</td> <td>1.8</td> </tr> <tr> <td>ALT</td> <td>1480</td> <td>1140</td> <td>810</td> </tr> </table>					CDFA 3.2° / 5.51%			DME KV	4	3	2	DIST TO THR	3.8	2.8	1.8	ALT	1480	1140
CDFA 3.2° / 5.51%																			
DME KV	4	3	2																
DIST TO THR	3.8	2.8	1.8																
ALT	1480	1140	810																

MISSED APPROACH
Right turn climbing to 2000 FT to NDB RK.

CAT I	4.5	THR ELEV 145
-------	-----	--------------

CATEGORY	A	B
S-NDB 11	740 - 1500 595 (600-1.5/2.7)	
CIRCLING	740 - 1.5 594 (600-1.5)	850 - 1.6 704 (800-1.6)

NDB RWY 11 (CAT A-B) 55°35.13'N
012°07.89'E **ROSKILDE (EKRK)**

CHANGES: ATC FREQ CHG.

AIR COMMAND DENMARK - MIL_AIM 28 DEC 2023

MIPS

INSTRUMENT APPROACH CHART

AD ELEV 146

**NDB RWY 11 (CAT C-E)
ROSKILDE (EKRK)**

COPENHAGEN APPROACH 119.805		ROSKILDE ATIS 123.805		ROSKILDE APPROACH 125.530		ROSKILDE TOWER 118.905 119.655	
NDB RK 368	DME KV CH 52x	APP COURSE 112°	FAF ALT 1700 FT	DESCENT GR 3.2° (5.51%)	MDA 740	THR ELEV 145 FT	ALS LENGTH 900 M LDA 5708 FT

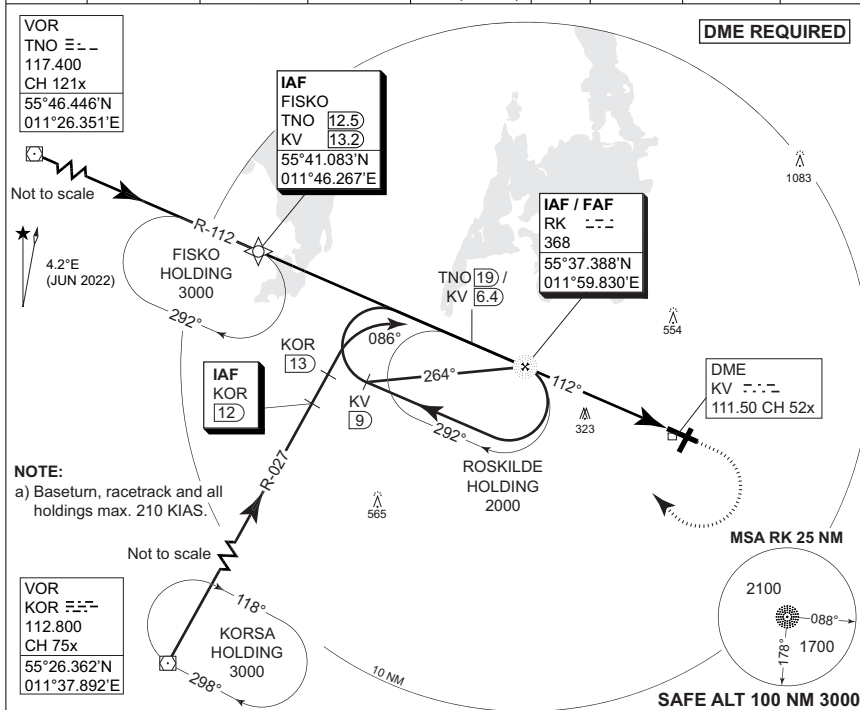

NOTE:
a) Baseturn, racetrack and all holdings max. 210 KIAS.

VOR
KOR 112.800
CH 75x
55°26.362'N
011°37.892'E

TA 5000

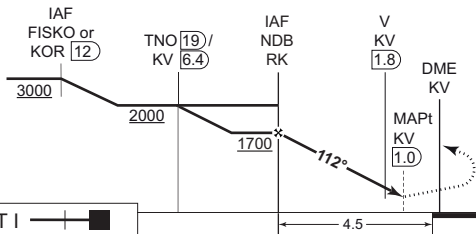

CDFA 3.2° / 5.51%			
DME KV	4	3	2
DIST TO THR	3.8	2.8	1.8
ALT	1480	1140	810

MISSED APPROACH
Right turn climbing to 2000 FT to NDB RK. MAX IAS 185 KT until turn completed.

CAT I

CATEGORY	C	D	E
S-NDB 11	740 - 2000 595 (600-2.0/2.7)		
CIRCLING	950 - 2400 804 (900-2.4)	950 - 3600 804 (900-3.6)	1050 - 3600 904 (1000-3.6)

NDB RWY 11 (CAT C-E)

55°35.13'N
012°07.89'E

ROSKILDE (EKRK)

CHANGES: ATC FREQ CHG.

AIR COMMAND DENMARK - MIL_AIM 28 DEC 2023

MIPS
INSTRUMENT APPROACH CHART

ILS or LOC RWY 21
ROSKILDE (EKRK)

AD ELEV 146

COPENHAGEN APPROACH 119.805		ROSKILDE ATIS 123.805		ROSKILDE APPROACH 125.530		ROSKILDE TOWER 118.905 119.655	
LOC/DME SN 108.70 CH 24x	APP COURSE 207°	GS INTCP ALT 3000 FT	GS 3.00°	DA 346	THR ELEV 146 FT	ALS LENGTH 900 M	LDA 4921 FT

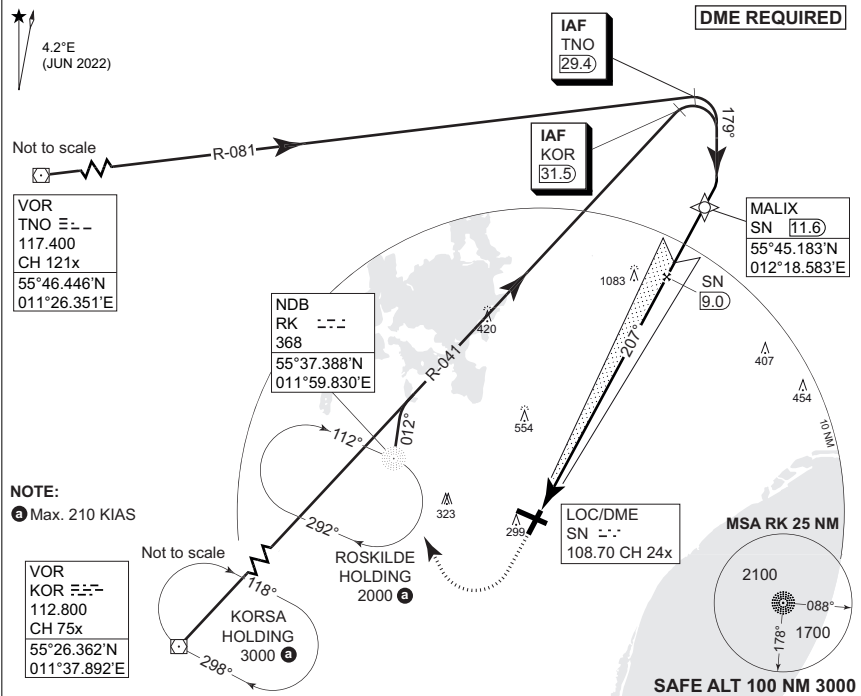

LOC ONLY CDF 3.0° / 5.2%								
DME SN	2	3	4	5	6	7	8	
DIST TO THR	1.8	2.8	3.8	4.8	5.8	6.8	7.8	
ALT	780	1100	1420	1730	2050	2370	2680	

TA 5000
GS 3.0
RDH 50

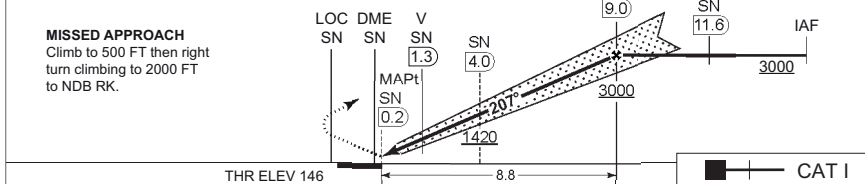

CATEGORY	A	B	C	D	E
S-ILS 21	346 - 550 200 (200-0.8/1.2)				
S-LOC 21	540 - 1100 394 (400-1.1/1.8)				
CIRCLING	610 - 1.5 464 (500-1.5)	850 - 1.6 704 (800-1.6)	950 - 2.4 804 (900-2.4)	950 - 3.6 804 (900-3.6)	1050 - 3.6 804 (1100-3.6)

ILS or LOC RWY 21 55°35.13'N **ROSKILDE (EKRK)**
012°07.89'E

CHANGES: ATC FREQ CHG.

AIR COMMAND DENMARK - MIL-AIM 28 DEC 2023

AERODROME CHART

RYGGE (ENRY)

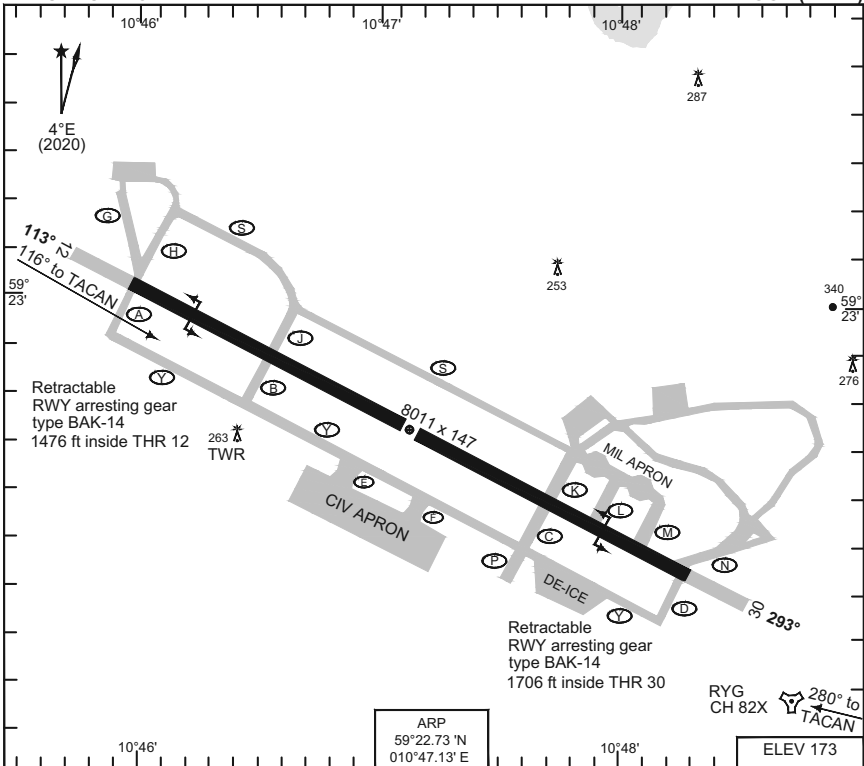

RWY	PCN	TORA	ASDA	TODA	LDA	PAPI	THR ELEV	THR PSN
12	85 F/C/X/T	8011	8011	8822	8011	3.0°	168	59°23.02' N - 010°45.97' E
30	85 F/C/X/T	8011	8011	8208	8011	3.0°	169	59°22.43' N - 010°48.28' E

ATIS 136.180
 RYGGE GND 121.705
 RYGGE TWR 119.505 122.100 308.850 257.800

CHANGES: FREQUENCIES

RIN/AF 20 MAR 2025

AERODROME CHART

RYGGE (ENRY)

**MIPS
INSTRUMENT DEPARTURE CHART**

**SID EAST
RYGGE (ENRY)**

ATIS 136.180	RYGGE TWR 122.100 308.850	FARRIS APP E 124.355 W 134.055								
POLARIS CONTROL 125.055	AD ELEV 173	RWY	GS (kt)	FROM-TO	60	120	180	240	300	REASON
		12	V/V (fpm)	DER-3000	280	560	840	1120	1400	
		30	V/V (fpm)	DER-3000	340	680	1020	1360	1700	ATC

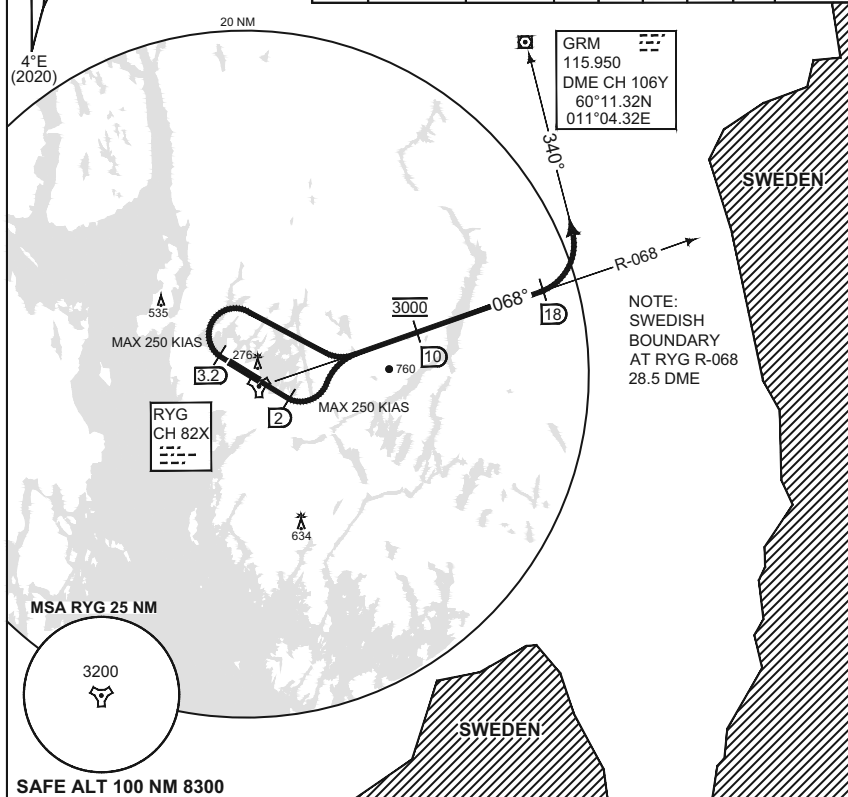

SAFE ALT 100 NM 8300 **TA 7000**

SID EAST RWY 12	- Climb RWY track to 1000 ft or RYG 2 DME, whichever occurs first, then turn left to intercept R-068 outbound to 18 DME. Maximum 250 KIAS. Cross 10 DME at 3000 ft. Follow ATC instruction. - Minimum climb gradient 4.6% (2.7°) to 3000 ft.
SID EAST RWY 30	- Climb RWY track to 1000 ft or RYG 3.2 DME, whichever occurs first, then turn right to intercept R-068 outbound to 18 DME. Maximum 250 KIAS. Cross 10 DME at 3000 ft. Follow ATC instruction. - Minimum climb gradient 5.5% (3.2°) to 3000 ft.

CHANGES, FREQUENCIES

RNOAF 20 MAR 2025

RYGGE SID EAST

59°22.73' N
010°47.13' E

RYGGE (ENRY)

**MIPS
INSTRUMENT DEPARTURE CHART**

**SID WEST
RYGGE (ENRY)**

ATIS 136.180	RYGGE TWR 119.505	122.100	308.850	FARRIS APP 124.355 134.055						
POLARIS CONTROL 125.055	AD ELEV 173	RWY	GS (kt)	FROM-TO	60	120	180	240	300	REASON
		12	V/V (fpm)	DER-4000	330	660	990	1320	1650	ATC
		30	V/V (fpm)	DER-4000	220	440	660	880	1100	

WARNING:

- CLOSE-IN OBSTACLES RISING TERRAIN/VEGETATION FROM DER RWY 30 TO 0.4 NM NW MUST BE AVOIDED VISUALLY.

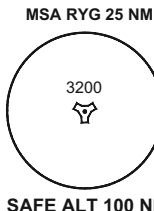
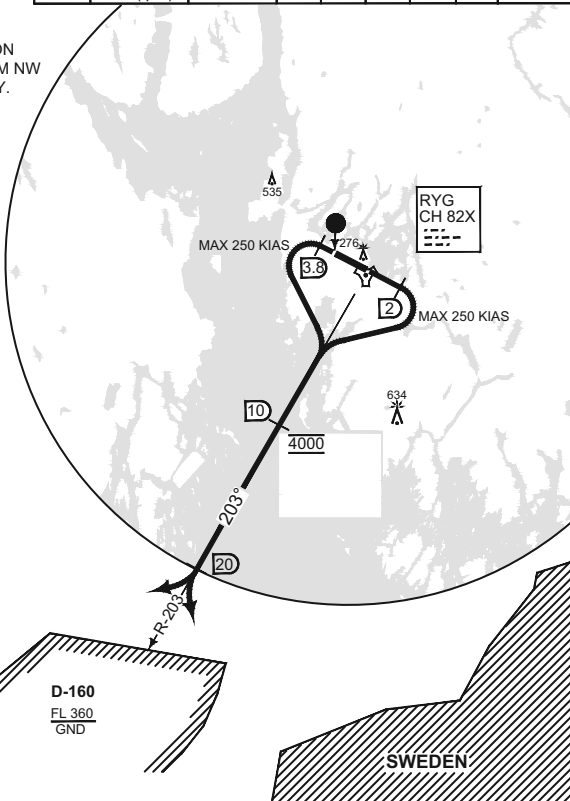
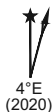

SAFE ALT 100 NM 8300

TA 7000

SID WEST RWY 12	- Climb RWY track to 1000 ft or 2 DME RYG, whichever occurs first, then turn right to intercept R-203 outbound to 20 DME. Maximum 250 KIAS. Cross 10 DME at 4000 ft. - Minimum climb gradient 5.4% (3.1°) to 4000 ft.
● SID WEST RWY 30	- Climb RWY track to 1000 ft or RYG 3.8 DME, whichever occurs first, then turn left to intercept R-203 outbound to 20 DME. Maximum 250 KIAS. Cross 10 DME at 4000 ft. - Minimum climb gradient 3.6% (2.1°) to 4000 ft.

CHANGES, FREQUENCIES

RNOAF 20 MAR 2025

RYGGE SID WEST

59°22.73' N
010°47.13' E

RYGGE (ENRY)

**MIPS
INSTRUMENT APPROACH CHART**

AD ELEV 173

**TACAN RWY 12
RYGGE (ENRY)**

ATIS 136.180	RYGGE GND 121.705	RYGGE TWR 119.505 122.100 308.850	FARRIS APP (WEST) 134.055	FARRIS APP (EAST) 124.355			
TACAN RYG CH 82X	APP COURSE 116°	FAF ALT 1600	Descent GR 5.2%(3.0°)	MDA 610	THR ELEV 168	ALS 900 m	LDA 8011

CAUTION:

- a) MAX HOLDING SPEED 250 KIAS.
- b) FINAL OFFSET 3° NORTH OF RWY CENTERLINE.

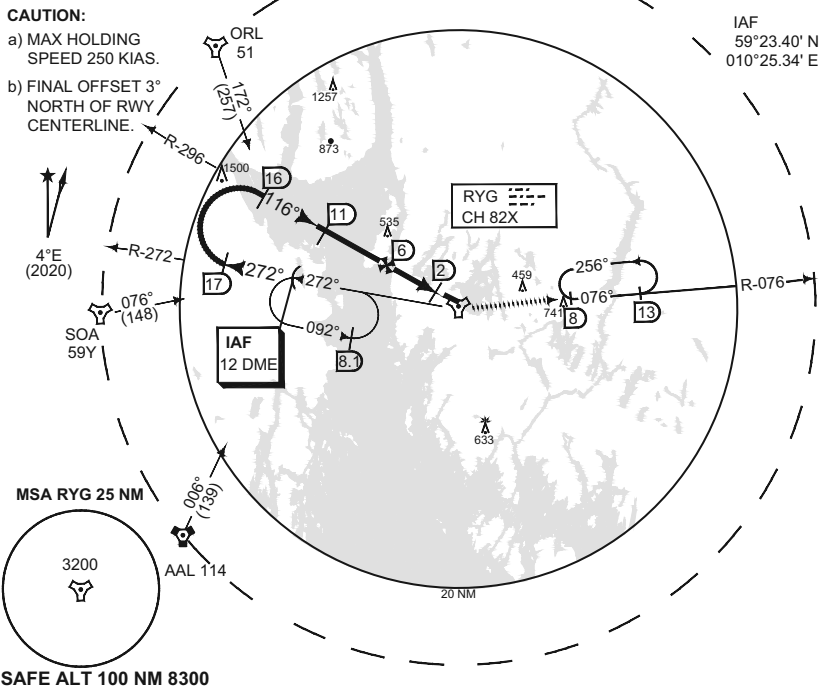

SAFE ALT 100 NM 8300

DME	5	4	3
ALT RYG	1290	980	660

TA 7000

MISSED APPROACH
At RYG 2 DME climb 116°. Passing 1000 ft turn left to intercept R-076 outbound and climb to 4000 ft. Enter holding at R-076/13 DME.

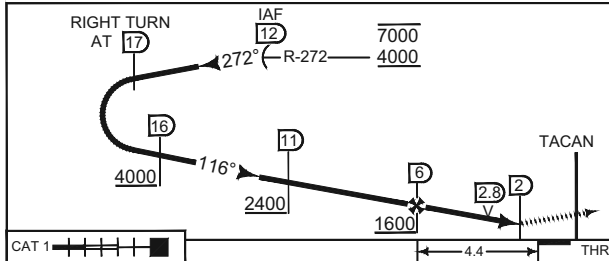

CAT 1	THR ELEV 168				
CATEGORY	A	B	C	D	E
S-TAC 12	610 - 1400 442 (400-1.4/2.1)				
CIRCLING	670 - 2.3 497 (500-2.3)	680 - 2.4 507 (600-2.4)	860 - 3.2 687 (700-3.2)	910 - 3.6 737 (800-3.6)	1150 - 4.5 977 (1000-4.5)

TACAN RWY 12

59°22.73' N
010°47.13' E

RYGGE (ENRY)

CHANGES: EDITORIALS

MIPS

RNOAF 19 FEB 2026

MIPS
INSTRUMENT APPROACH CHART

HPMA ILS or LOC RWY 30
RYGGE (ENRY)

AD ELEV 173

ATIS 136.180	RYGGE GND 121.705	RYGGE TWR 119.505 122.100 308.850	FARRIS APP (WEST) 134.055	FARRIS APP (EAST) 124.355			
ILS/DME RY 109.100 / CH 28X	APP COURSE 293°	GS INTCP ALT 3000	GS 3.0°	DA 388	THR ELEV 169	ALS 720 m	LDA 8011

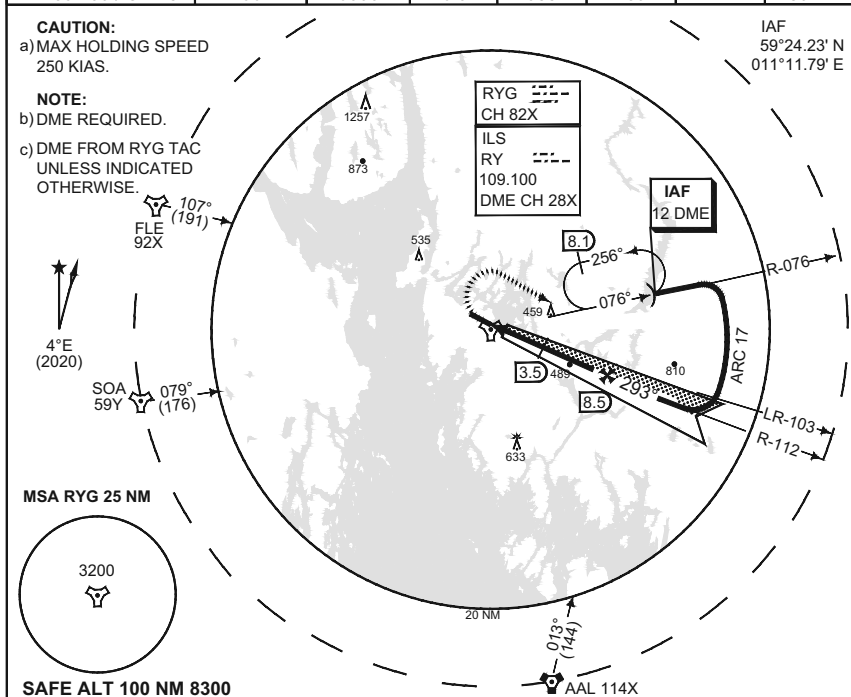

DME	2	3	4	5	6	7	8
ALT RYG	960	1290	1610	1940	2270	2600	2930
ALT RY	800	1130	1450	1780	2110	2440	2770

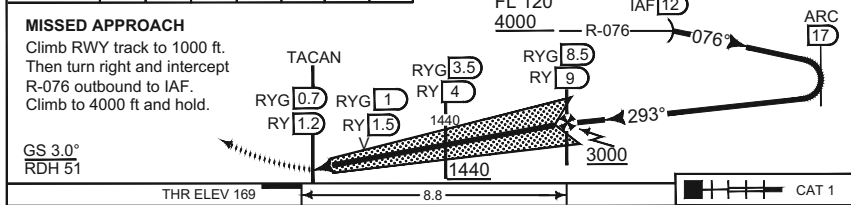

CHANGES: FREQUENCIES	MIPS	HPMA
CATEGORY		HPMA
S-ILS 30		388 - 550 219 (300-0.8/1.2)
S-LOC 30		610 - 1400 441 (500-1.4/2.1)
CIRCLING		730 - 3.2 557 (600-3.2)

HPMA ILS or LOC RWY 30 59°22.73' N 010°47.13' E **RYGGE (ENRY)**

MIPS
INSTRUMENT APPROACH CHART

ILS M or LOC M RWY 30
RYGGE (ENRY)

AD ELEV 173

ATIS 136.180	RYGGE GND 121.705	RYGGE TWR 119.505 122.100 308.850	FARRIS APP (WEST) 134.055	FARRIS APP (EAST) 124.355			
ILS/DME RY 109.100 / CH 28X	APP COURSE 293°	GS INTCP ALT 3000	GS 3.0°	DA SEE CAT	THR ELEV 169	ALS 720 m	LDA 8011

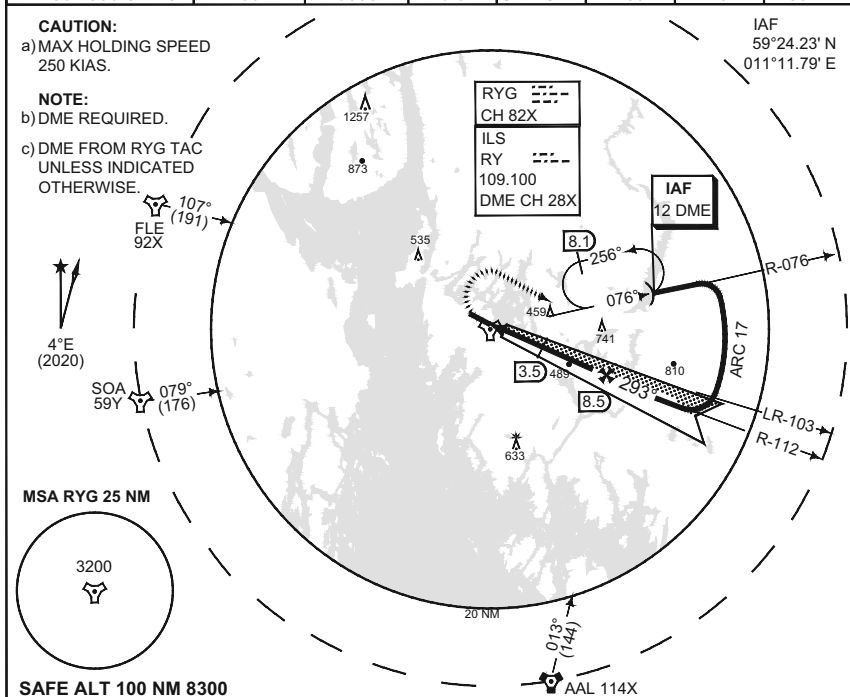

DME	2	3	4	5	6	7	8	
ALT RYG	960	1290	1610	1940	2270	2600	2930	
ALT RY	800	1130	1450	1780	2110	2440	2770	

TA 7000

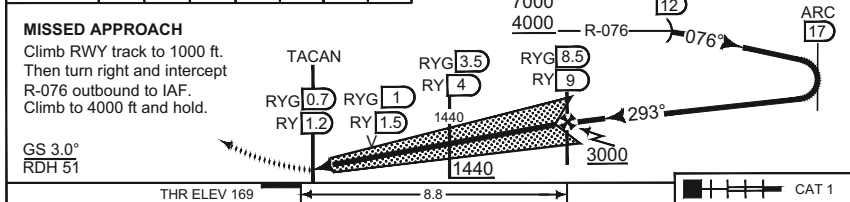

CATEGORY	A	B	C	D	E
S-ILS 30	377 - 550 208 (300-0.8/1.2)	385 - 550 216 (300-0.8/1.2)	391 - 550 222 (300-0.8/1.2)	401 - 550 232 (300-0.8/1.2)	419 - 550 250 (300-0.8/1.3)
S-LOC 30	610 - 1400 441 (500-1.4/2.1)				
CIRCLING	670 - 2.3 497 (500-2.3)	670 - 2.3 497 (500-2.3)	860 - 3.2 687 (700-3.2)	880 - 3.6 707 (800-3.6)	1120 - 4.3 947 (1000-4.3)

ILS M or LOC M RWY 30 59°22.73' N **RYGGE (ENRY)**
010°47.13' E

CHANGES: FREQUENCIES

RNOAF 20 MAR 2025

MIPS
INSTRUMENT APPROACH CHART

AD ELEV 173

TACAN RWY 30
RYGGE (ENRY)

ATIS 136.180	RYGGE GND 121.705	RYGGE TWR 119.505 122.100	308.850	FARRIS APP (WEST) 134.055	FARRIS APP (EAST) 124.355		
TACAN RYG CH 82X	APP COURSE 280°	FAF ALT 2000	Descent GR 5.6% (3.2°)	MDA 570	THR ELEV 169	ALS 720 m	LDA 8011

CAUTION:

- a) MAX HOLDING SPEED 250 KIAS.
- b) FINAL OFFSET 13° NORTH OF RWY CENTERLINE.

IAF
59°24.23' N
011°11.79' E

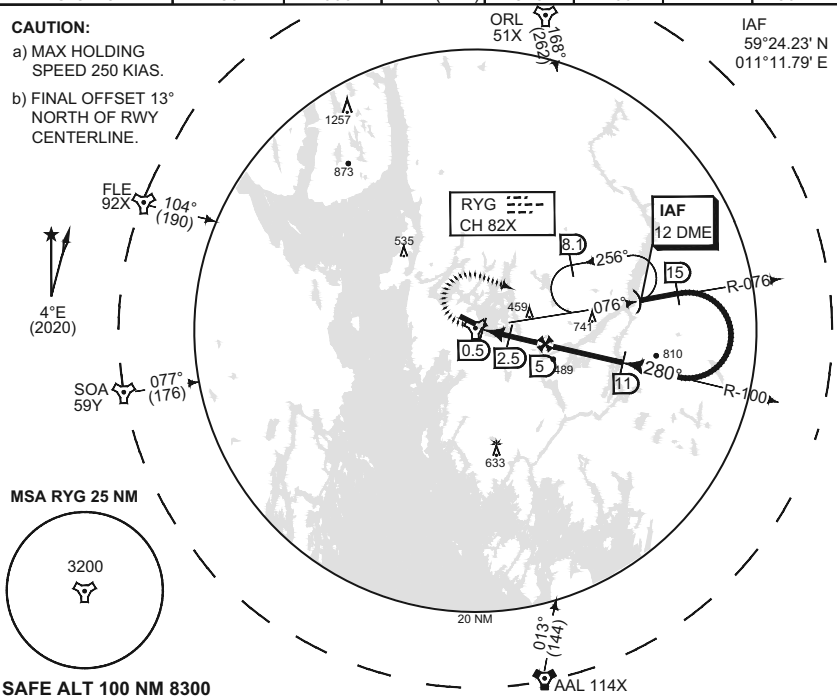

SAFE ALT 100 NM 8300

DME	1	2	3	4
ALT RYG	660	990	1330	1670

TA 7000

MISSED APPROACH

At 0.5 DME climb on track 293° to 1000 ft, then turn right and intercept R-076 outbound to IAF. Climb to 4000 ft and hold.

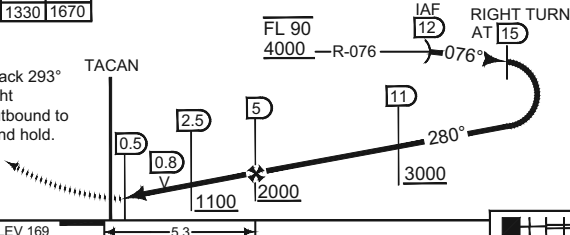

CATEGORY	A	B	C	D	E
S-TAC 30	570 - 1200 401 (500-1.2/1.9)				
CIRCLING	670 - 2.3 497 (500-2.3)	680 - 2.4 507 (600-2.4)	860 - 3.2 687 (700-3.2)	910 - 3.6 737 (800-3.6)	1150 - 4.5 977 (1000-4.5)

TACAN RWY 30

59°22.73' N
010°47.13' E

RYGGE (ENRY)

CHANGES: EDITORIALS

MIPS

RNGAF 19 FEB 2026

AERODROME CHART

SKRYDSTRUP (EKSP)

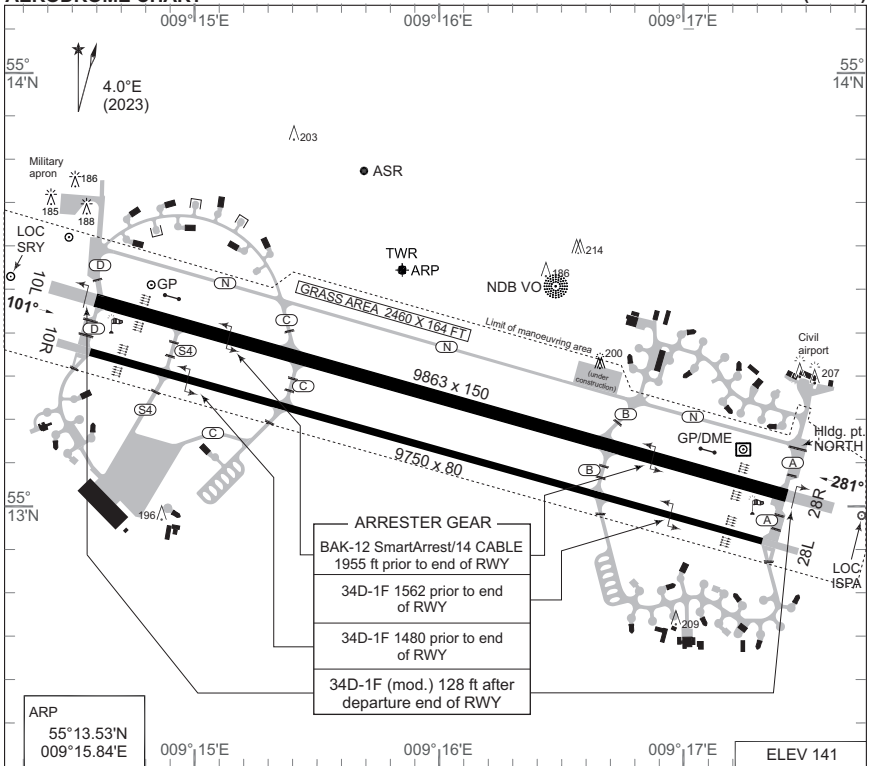

ARRESTER GEAR
 BAK-12 SmartArrest/14 CABLE
 1955 ft prior to end of RWY
 34D-1F 1562 prior to end of RWY
 34D-1F 1480 prior to end of RWY
 34D-1F (mod.) 128 ft after departure end of RWY

ARP
 55°13.53'N
 009°15.84'E

ELEV 141

RWY	PCN	PCR	DECLARED DISTANCES				PAPI	THR ELEV	THR PSN
			TORA	TODA	ASDA	LDA			
10L	F/B/W/T Asphalt/ Concrete	600 R/C/W/T Asphalt/ Concrete	9863	9863	10597	9863	3°	126	55°13.48'N 009°14.64'E
28R	F/B/W/T Asphalt/ Concrete	600 R/C/W/T Asphalt/ Concrete	9863	9863	10600	9863	3°	141	55°13.05'N 009°17.37'E
10R	F/B/W/T Asphalt/ Concrete	77 F/C/X/T Asphalt/ Concrete	9750	9750	10237	9750	3°	124	55°13.36'N 009°14.60'E
28L	F/B/W/T Asphalt/ Concrete	77 F/C/X/T Asphalt/ Concrete	9750	9750	10237	9750	3°	139	55°12.94'N 009°17.30'E

SKRYDSTRUP TWR 118.280 286.375
 SKRYDSTRUP ATIS 133.905

Omnidirectional IFR-departures:

RWY 10L & R: Climb straight ahead to at least 700 FT AMSL before turn is commenced.
 RWY 28R & L: Climb straight ahead to at least 600 FT AMSL before turn is commenced.

	PROC. CRITERIA	RWY	GS	TCH	OTCH	RPI	CAT	MINIMA CRITERIA	MINIMA
PAR	INTENTIONALLY LEFT BLANK								
SRA	INTENTIONALLY LEFT BLANK								

CHANGES: MAG VAR CORRECTED.

AIR COMMAND DENMARK - MIL AIM 19 FEB 2025

AERODROME CHART

SKRYDSTRUP (EKSP)

MIPS
INSTRUMENT APPROACH CHART

ILS or LOC RWY 10L
SKRYDSTRUP (EKSP)

AD ELEV 141

COPENHAGEN CONTROL 360.100 133.155		SKRYDSTRUP ATIS 133.905		SKRYDSTRUP APPROACH 280.750 124.105		SKRYDSTRUP TOWER 286.375 118.280		
LOC-DME ISPA 109.35/CH 30y		APP COURSE 101°	FAP/FAP ALT 2000 FT	GS 3.00°	DA 326	THR 126	ALS length 900 M	LDA 9863 FT

NOTE:
SPEED RESTRICTION ACFT CAT C-E: /
Base turn limited to 240 KIAS maximum

ADF AND DME REQUIRED

IAF (NDB VO)
55°13.48'N
009°16.42'E

TISET
55°16.63'N
008°54.41'E

FAP/FAP
55°14.99'N
009°04.97'E

★ ↑
4.0°E
(JAN 2023)

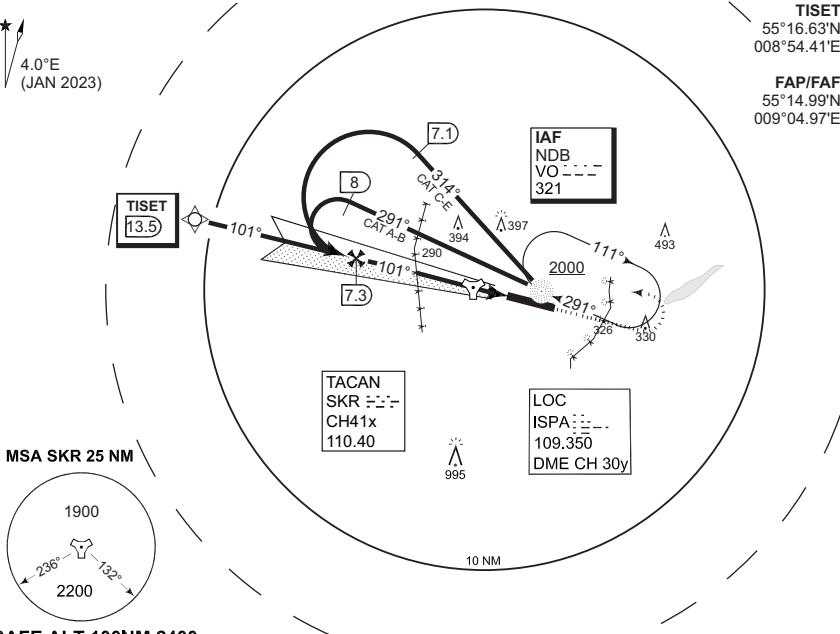

TA 3000
GS 3.00°
RDH 50

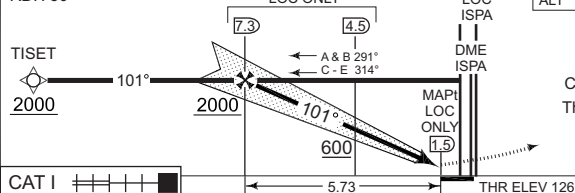

LOC ONLY (CDFA 3.0° / 5.24%)					
DIST TO THR (NM)	5	4	3	2	1
DME ISPA (NM)	6.5	5.5	4.5	3.5	2.5
ALT	1770	1450	1130	820	500

MISSED APPROACH

Climb on HDG 101° to 2000 FT.
Then turn left to join NDB VO holding.

CATEGORY	A		B		C		D		E	
S-ILS 10L					326 -550 200 (200-0.8/1.2)					
S-LOC 10L					410 -750 284 (300-0.8/1.4)					
CIRCLING	630	-1.5 489 (500-1.5)	700	-1.6 559 (600-1.6)	800	-2.4 659 (700-2.4)	900	-3.6 759 (800-3.6)	1490	-3.6 1349 (1400-3.6)

ILS or LOC RWY 10L

55°13.53'N
009°15.84'E

SKRYDSTRUP (EKSP)

CHANGES: MAG VAR CORRECTED, CAT D CIRCLING MINIMA RAISED

AIR COMMAND DENMARK - MIL AIM 19 FEB 2028

MIPS
INSTRUMENT APPROACH CHART

AD ELEV 141

ILS Z or LOC Z RWY 10L
SKRYDSTRUP (EKSP)

COPENHAGEN CONTROL 360.100 133.155		SKRYDSTRUP ATIS 133.905		SKRYDSTRUP APPROACH 280.750 124.105		SKRYDSTRUP TOWER 286.375 118.280		
TACAN SKR 110.40/CH 41x	LOC ISPA 109.35	APP COURSE 101°	FAP/FAF ALT 2000 FT	GS 3.00°	DA 326	THR 126	ALS length 900 M	LDA 9863 FT

CAUTION:

THE DME INDICATIONS ARE FROM TACAN SKR
- NOT FROM THE DME ASSOCIATED WITH THE ILS

NOTE: RADAR VECTORS
TO FINAL REQUIRED

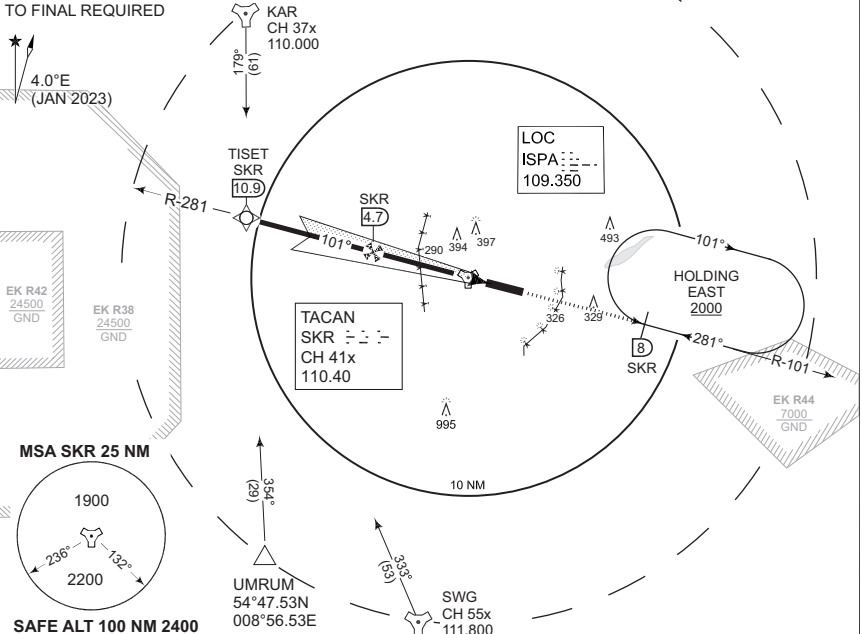

TA 3000

GS 3.00°
RDH 50



LOC ONLY (CDFA 3.0° / 5.24%)					
DIST TO THR (NM)	5	4	3	2	1
DME SKR (NM)	3.9	2.9	1.9	0.9	0.1
ALT	1770	1450	1140	820	500

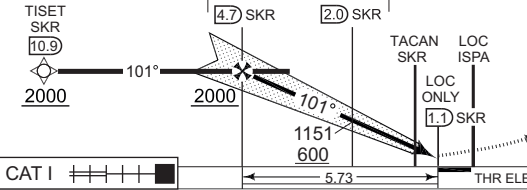

MISSED APPROACH

Climb to 2000 FT on
R-101 to SKR 8 DME
and join holding EAST.

CAT I

CATEGORY	A		B		C		D	E
S-ILS 10L					326 -550 200 (200-0.8/1.2)			
S-LOC 10L					410 -750 284 (300-0.8/1.4)			
CIRCLING	630	-1.5 489 (500-1.5)	700	-1.6 559 (600-1.6)	800	-2.4 659 (700-2.4)	890 -3.6 749 (800-3.6)	1490 -3.6 1349 (1400-3.6)

ILS Z or LOC Z RWY 10L

55°13.53'N
009°15.84'E

SKRYDSTRUP (EKSP)

CHANGES: EDITORIAL

AIR COMMAND DENMARK - MIL AIM 16 APR 2026

MIPS

INSTRUMENT APPROACH CHART

AD ELEV 141

HPMA TACAN RWY 10L
SKRYDSTRUP (EKSP)

COPENHAGEN CONTROL 360.100 133.155		SKRYDSTRUP ATIS 133.905		SKRYDSTRUP APPROACH 280.750 124.105		SKRYDSTRUP TOWER 286.375 118.280		
TACAN SKR CH 41x	APP COURSE 100°	FAF ALT 2000 FT	DESCENT GR. 5.24% (318 FT/NM)		MDA 460	THR ELEV 126	ALS LENGTH 900 M	LDA 9863 FT

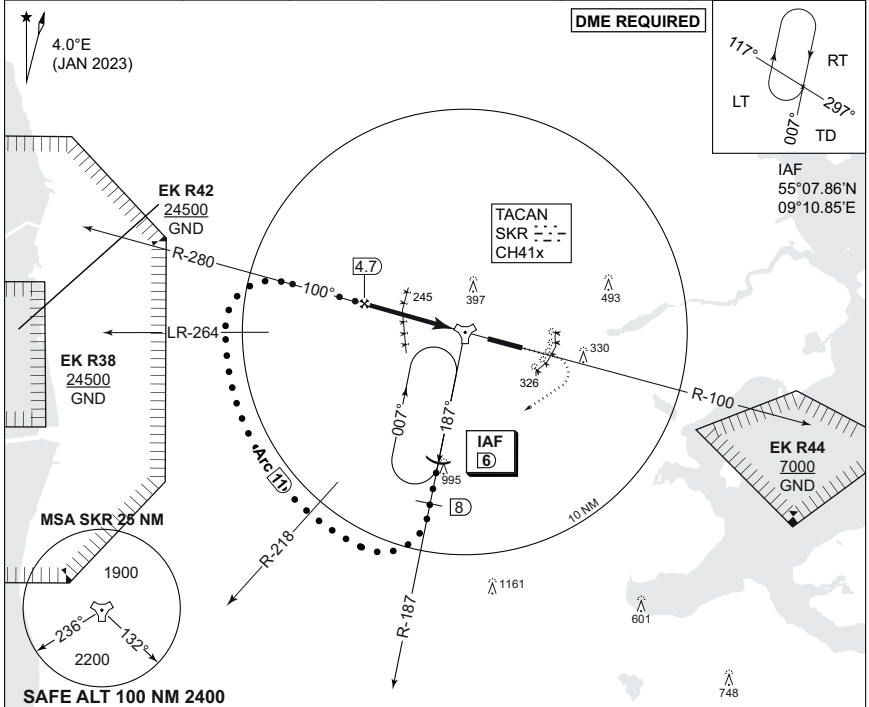

CHANGES: MAG VAR CORRECTED. MULTIPLE COURSES CORRECTED.

AIR COMMAND DENMARK - MIL-AIM 19 FEB 2025

CATEGORY	HPMA
S-TACAN 10L	460 - 800 334 (400-0.8/1.5)
CIRCLING	700 - 3.2 559 (600-3.2)

HPMA TACAN RWY 10L

55°13.53'N
009°15.84'E

SKRYDSTRUP (EKSP)

MIPS
INSTRUMENT APPROACH CHART

TACAN RWY 10L
SKRYDSTRUP (EKSP)

AD ELEV 141

COPENHAGEN CONTROL 360.100 133.155		SKRYDSTRUP ATIS 133.905		SKRYDSTRUP APPROACH 280.750 124.105		SKRYDSTRUP TOWER 286.375 118.280	
TACAN SKR CH 41x	APP COURSE 100°	FAF ALT 2000 FT	DESCENT GR 319 FT/NM	MDA See minima	THR ELEV 126	ALS length 900 M	LDA 9863 FT

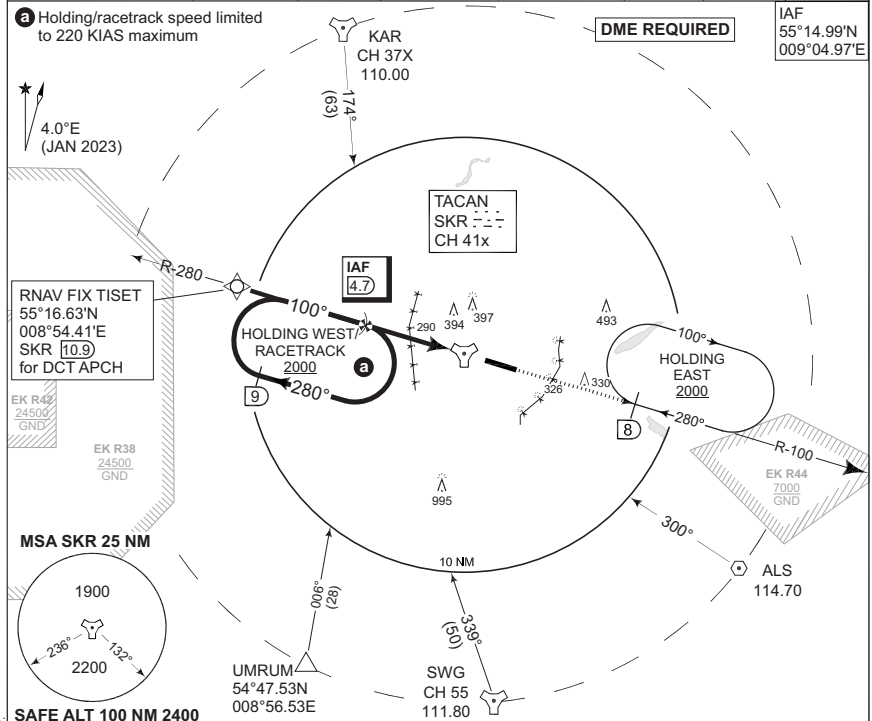

TA 3000	CDFA 3.0° / 5.24%					
	DME SKR	4	3	2	1	0
	DIST to THR	5.1	4.1	3.1	2.1	1.1
ALT	1790	1470	1150	830	520	

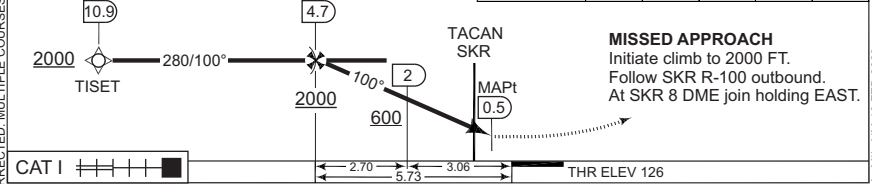

CATEGORY	A	B	C	D	E
S-TACAN 10L	430 -750 304 (400-0.8/1.4)				
CIRCLING	630 -1.5 489 (500-1.5)	700 -1.6 559 (600-1.6)	800 -2.4 659 (700-2.4)	890 -3.6 749 (800-3.6)	1490 -3.6 1349 (1400-3.6)

TACAN RWY 10L 55°13.53'N 009°15.84'E **SKRYDSTRUP (EKSP)**

CHANGES: MAG VAR CORRECTED, MULTIPLE COURSES CORRECTED

AIR COMMAND DENMARK - MIL AIM 19 FEB 2028

MIPS INSTRUMENT APPROACH CHART

RNP RWY 10L SKRYDSTRUP (EKSP)

AD ELEV 141

COPENHAGEN CONTROL 360.100 133.155		SKRYDSTRUP ATIS 133.905		SKRYDSTRUP APPROACH 280.750 124.105		SKRYDSTRUP TOWER 286.375 118.280	
TACAN SKR 110.40/CH 41x	APP COURSE 101°	FAF 2000 FT	Descent GR 3.0° (5.24%)	MDA See CAT	THR ELEV 126	ALS LENGTH 900 M	LDA 9863 FT

CAUTION: IAF NIREK not available when EK R38 is active

RNP APCH

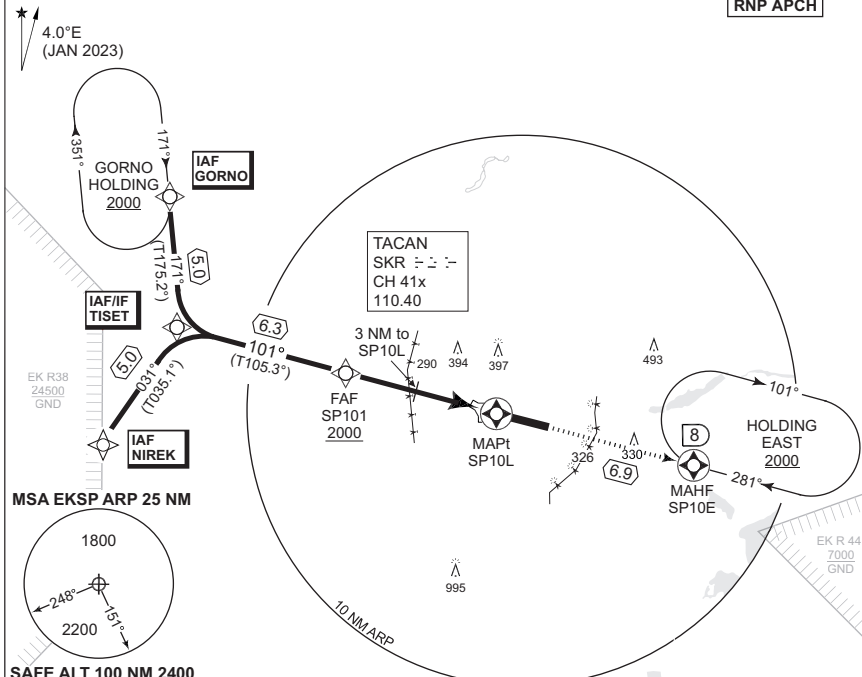

SAFE ALT 100 NM 2400

CDFA 3.0° / 5.24%

DIST THR	5	4	3	2	1
ALTITUDE	1770	1450	1130	820	500

TA 3000
TCH 50

MISSED APPROACH RNP
Climb to 2000 ft on track 101° to SP10E and join Holding East.
Non-RNP: Climb to 2000 FT on SKR R-101 to 8 DME and join Holding East.

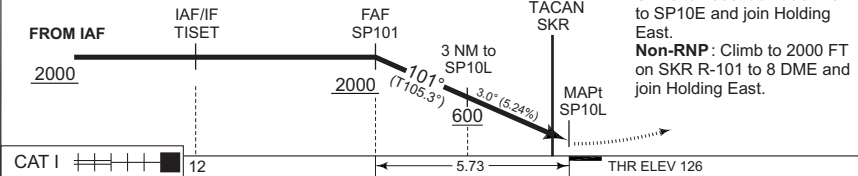

CAT I

CATEGORY	A	B	C	D	E
LNAV (MDA)	440 - 750 314 (400-0.8/1.4)		450 - 800 324 (400-0.8/1.5)		
CIRCLING	630 - 1.5 489 (500-1.5)	700 - 1.6 559 (600-1.6)	800 - 2.4 659 (700-2.4)	890 - 3.6 749 (800-3.6)	1490 - 3.6 1349 (1400-3.6)

RNP RWY 10L

55°13.53'N
009°15.84'E

SKRYDSTRUP (EKSP)

CHANGES: MAG VAR CORRECTED.

AIR COMMAND DENMARK - MIL AIM 19 FEB 2028

EKSP RNP RWY 10L waypoint coordinates:

RWY 10L from GORNO (Initial LEFT) APPROACH RNP

		CODING				DISPLAY	
GORNO	IAF	55 21 36.42N	008 53 40.61E	55 21.607N	008 53.677E		
TISET	IF	55 16 38.04N	008 54 24.63E	55 16.634N	008 54.411E		
SP101	FAF	55 14 59.49N	009 04 58.83E	55 14.992N	009 04.981E		
SP10L	MAPt	55 13 28.56N	009 14 38.19E	55 13.476N	009 14.637E		
SP10E	MAHF	55 11 41.35N	009 26 14.79E	55 11.689N	009 26.247E		

RWY 10L from NIREK (Initial RIGHT) APPROACH RNP

		CODING				DISPLAY	
NIREK	IAF	55 12 32.90N	008 49 23.52E	55 12.548N	008 49.392E		
TISET	IF	55 16 38.04N	008 54 24.63E	55 16.634N	008 54.411E		
SP101	FAF	55 14 59.49N	009 04 58.83E	55 14.992N	009 04.981E		
SP10L	MAPt	55 13 28.56N	009 14 38.19E	55 13.476N	009 14.637E		
SP10E	MAHF	55 11 41.35N	009 26 14.79E	55 11.689N	009 26.247E		

Threshold coordinates RWY 10L

		CODING		DISPLAY	
RWY 10L		55 13 28.56N	009 14 38.19E	55 13.476N	009 14.637E

MIPS
INSTRUMENT APPROACH CHART

ILS or LOC RWY 28R
SKRYDSTRUP (EKSP)

AD ELEV 141

COPENHAGEN CONTROL 360.100 133.155		SKRYDSTRUP ATIS 133.905	SKRYDSTRUP APPROACH 280.750 124.105		SKRYDSTRUP TOWER 286.375 118.280	
LOC / DME SRY 109.35/CH 30y	APP COURSE 281°	GS INTCP ALT 2200 FT	GS 3.0°	DA 341	THR ELEV 141	ALS LENGTH 900 M
						LDA 9863 FT

NOTE:
SPEED RESTRICTION ACFT CAT C-E:
Base turn limited to 240 KIAS maximum

ADF AND DME REQUIRED

IAF (NDB VO)
55°13.48'N
009°16.42'E

DINUT
55°09.98'N
009°36.47'E

FAP/FAF
55°11.37'N
009°27.92'E

4.0°E
(JAN 2023)

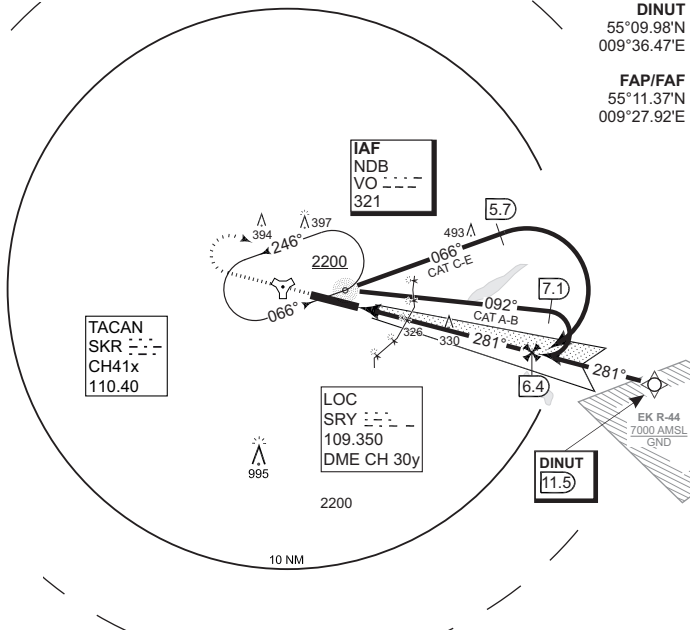

MSA SKR 25 NM

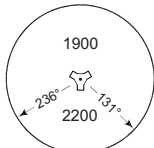

SAFE ALT 100NM 2400

LOC ONLY (CDFA 3.0° / 5.24%)						
DIST TO THR (NM)	1	2	3	4	5	6
DME SRY (NM)	1.1	2.1	3.1	4.1	5.1	6.1
ALT	500	820	1140	1460	1780	2100

TA 3000
GS 3.00°
RDH 41

MISSED APPROACH

Climb on RWY HDG to 2200 FT. Turn right to join holding at NDB VO.

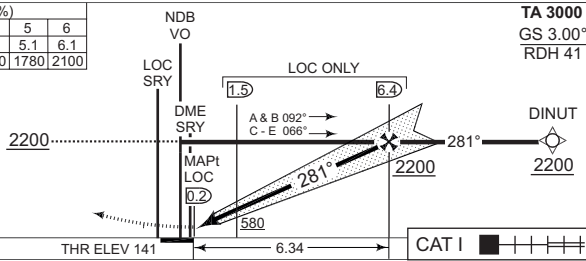

CATEGORY	A	B	C	D	E
S-ILS/DME 28R			341	-550 200 (200-0.8/1.2)	
S-LOC/DME 28R			470	-800 329 (400-0.8/1.5)	
CIRCLING	630	-1.5 489 (500-1.5)	700	-1.6 559 (600-1.6)	800
				-2.4 659 (700-2.4)	900
				-3.6 759 (800-3.6)	1490
					-3.6 1349 (1400-3.6)

ILS or LOC RWY 28R

55°13.53'N
009°15.84'E

SKRYDSTRUP (EKSP)

CHANGES: MAG VAR CORRECTED, CAT D CIRCLING MINIMA RAISED

AIR COMMAND DENMARK - MIL AIM 19 FEB 2028

MIPS
INSTRUMENT APPROACH CHART

ILS Z or LOC Z RWY 28R
SKRYDSTRUP (EKSP)

AD ELEV 141

COPENHAGEN CONTROL 360.100 133.155		SKRYDSTRUP ATIS 133.905	SKRYDSTRUP APPROACH 280.750 124.105		SKRYDSTRUP TOWER 286.375 118.280	
TACAN SKR 110.40/CH 41x	LOC SRY 109.35	APP COURSE 281°	GS INTCP ALT 2000 FT	GS 3.0°	DA 341	THR 141 ALS length 900 M LDA 9863 FT

CAUTION:
THE DME INDICATIONS ARE FROM TACAN SKR - NOT FROM THE DME ASSOCIATED WITH THE ILS
NOTE: RADAR VECTORS TO FINAL REQUIRED

DME REQUIRED

DINUT
55° 09.98'N
009° 36.48'E

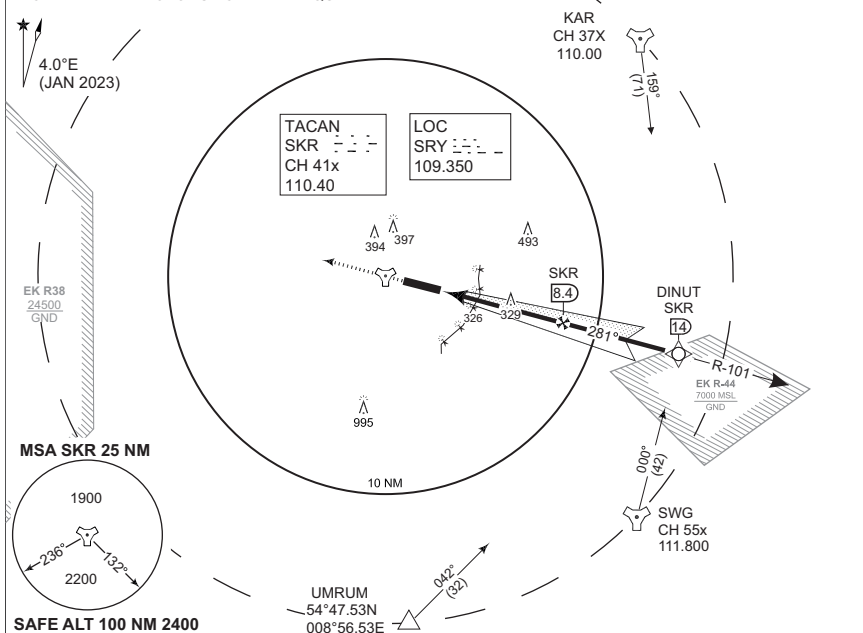

LOC ONLY (CDFA 3.0° / 5.24%)					
DIST TO THR (NM)	1	2	3	4	5
DME SKR (NM)	3.7	4.7	5.7	6.7	7.7
ALT	500	820	1140	1460	1780

TA 3000
GS 3.00°
RDH 41

MISSED APPROACH

Climb on track 283° to 2000 ft. Inform ATC.

Radio com. failure during Missed Approach:

Initiate climb to 2000 ft on track 281°.
When passing 1000 ft turn left inbound
SKR R-101/8.4 DME and hold.
Squawk 7600.

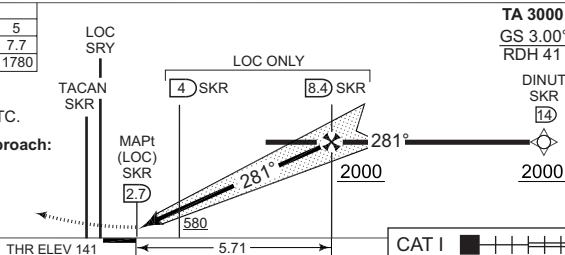

CATEGORY	THR ELEV 141					CAT I
	A	B	C	D	E	
S-ILS/DME 28R	341 -550 200 (200-0.8/1.2)					DINUT SKR 14
S-LOC/DME 28R	470 -800 329 (400-0.8/1.5)					
CIRCLING	630 -1.5 489 (500-1.5)	700 -1.6 559 (600-1.6)	800 -2.4 659 (700-2.4)	890 -3.6 749 (800-3.6)	1490 -3.6 1349 (1400-3.6)	

ILS Z or LOC Z RWY 28R

55°13.53'N
009°15.84'E

SKRYDSTRUP (EKSP)

CHANGES: EDITORIAL

MIPS

AIR COMMAND DENMARK - MIL AIM 16 APR 2026

MIPS

INSTRUMENT APPROACH CHART

**HPMA TACAN RWY 28R
SKRYDSTRUP (EKSP)**

AD ELEV 141

COPENHAGEN CONTROL 360.100 133.155		SKRYDSTRUP ATIS 133.905	SKRYDSTRUP APPROACH 280.750 124.105		SKRYDSTRUP TOWER 286.375 118.280	
---------------------------------------	--	----------------------------	--	--	-------------------------------------	--

TACAN SKR CH 41x	APP COURSE 281°	FAF ALT 2000 FT	DESCENT GR. 5.24% (318 FT/NM)	MDA 580	THR ELEV 141	ALS LENGTH 900 M	LDA 9863 FT
---------------------	--------------------	--------------------	----------------------------------	-------------------	-----------------	---------------------	----------------

DME REQUIRED

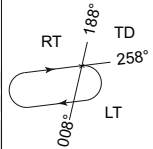

4.0°E
(JAN 2023)

IAF
55°15.11'N
09°30.15'E

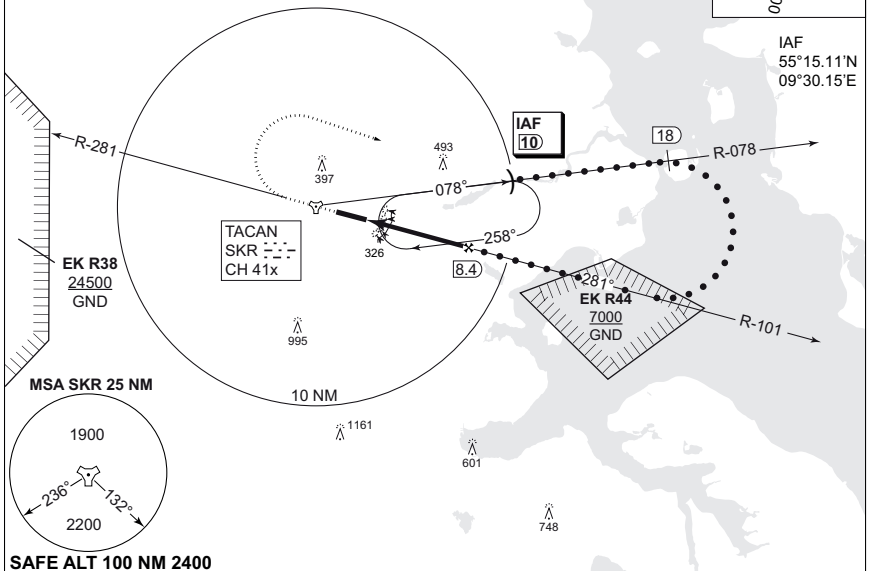

SAFE ALT 100 NM 2400

CDFA: 3.00° / 5.24%					
DME SKR	4	5	6	7	8
DIST THR	1.3	2.3	3.3	4.3	5.3
ALT	610	930	1250	1570	1890

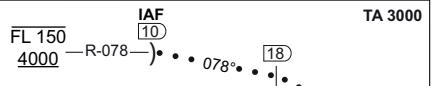

MISSED APPROACH
Climb on track 281° to 4000 ft. When passing 2000 ft turn right inbound IAF (SKR R-078 DME 10)

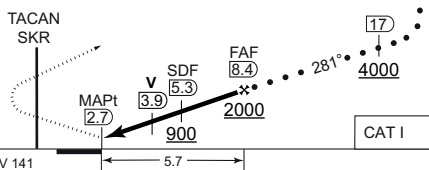

CHANGES: MAG VAR CORRECTED.

AIR COMMAND DENMARK - MIL/AMT 19 FEB 2026

CATEGORY	HPMA
S-TACAN 28R	580 - 1300 439 (500-1.3/2.0)
CIRCLING	700 - 3.2 559 (600-3.2)

HPMA TACAN RWY 28R

55°13.53'N
009°15.84'E

SKRYDSTRUP (EKSP)

MIPS INSTRUMENT APPROACH CHART

TACAN RWY 28R SKRYDSTRUP (EKSP)

AD ELEV 141

COPENHAGEN CONTROL 360.100 133.155		SKRYDSTRUP ATIS 133.905		SKRYDSTRUP APPROACH 280.750 124.105		SKRYDSTRUP TOWER 286.375 118.280	
TACAN SKR CH 41x	APP COURSE 281°	FAF ALT 2000 FT	DESCENT GR 319 FT/NM	MDA 580	THR ELEV 141	ALS length 900 M	LDA 9863 FT

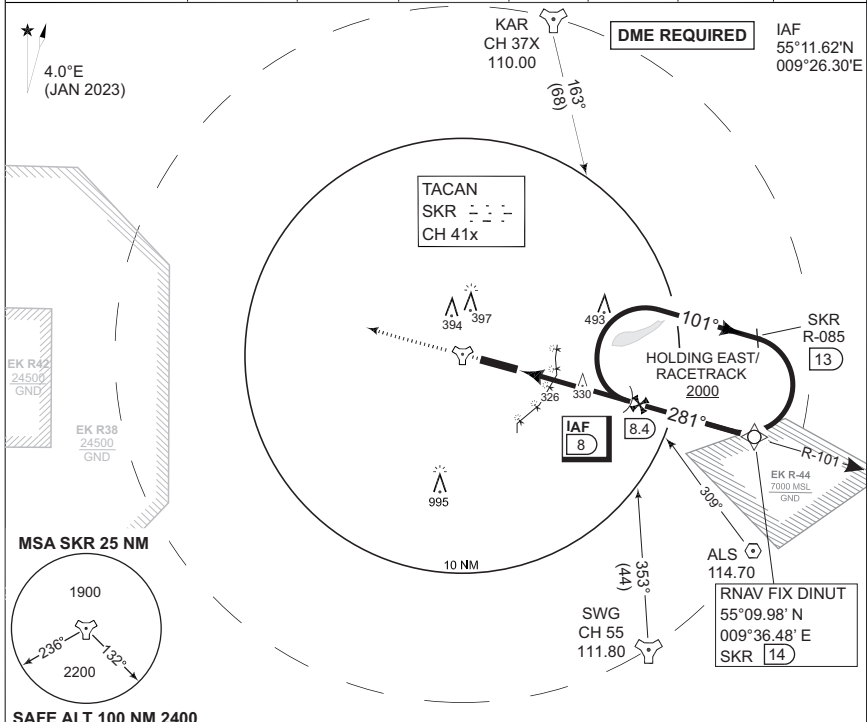

CDFA 3.0° / 5.24%					
DME SKR	4	5	6	7	8
DIST to THR	1.3	2.3	3.3	4.3	5.3
ALT	610	930	1250	1560	1880

MISSED APPROACH
Climb on track 281° to 2000 ft. Inform ATC. TACAN SKR

Radio communication failure during Missed Approach:
Initiate climb to 2000 ft on track 281°. When passing 1000 ft turn left inbound IAF and hold. Squawk 7600.

MAPt 2.7

THR ELEV 141

2.6 3.1 5.71

IAF R-101 8

101/281°

DINUT 2000

CAT I

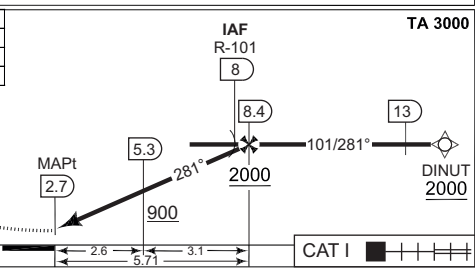

CATEGORY	A	B	C	D	E
S-TACAN 28R	580 - 1300 439 (500-1.3/1.5)			580 - 1300 439 (500-1.3/2.0)	
CIRCLING	630 -1.5 489 (500-1.5)	700 -1.6 559 (600-1.6)	800 -2.4 659 (700-2.4)	890 -3.6 749 (800-3.6)	1490 -3.6 1349 (1400-3.6)

TACAN RWY 28R

55°13.53'N
009°15.84'E

SKRYDSTRUP (EKSP)

CHANGES: MAG VAR CORRECTED

AIR COMMAND DENMARK - MIL AIM 19 FEB 2028

MIPS INSTRUMENT APPROACH CHART

RNP RWY 28R
SKRYDSTRUP (EKSP)

AD ELEV 141

COPENHAGEN CONTROL 360.100 133.155		SKRYDSTRUP ATIS 133.905		SKRYDSTRUP APPROACH 280.750 124.105		SKRYDSTRUP TOWER 286.375 118.280	
TACAN SKR 110.40/CH 41x	APP COURSE 282°	FAF 2000 FT	Descent GR 3.0° (5.24%)	MDA 580	THR ELEV 141	ALS LENGTH 900 M	LDA 9863 FT

a Missed approach holding speed limited to 220 KIAS maximum

RNP APCH

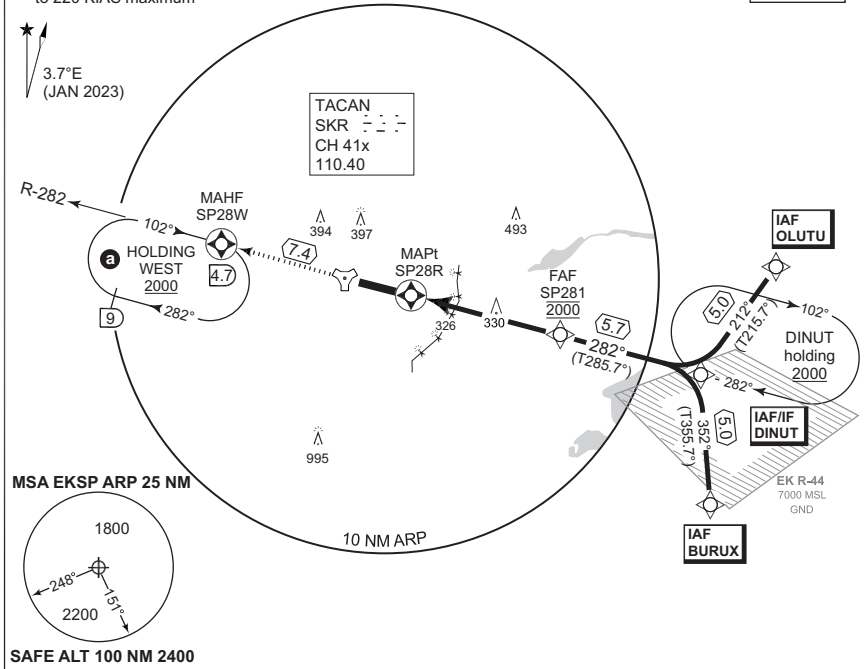

DIST	CDFA 3.0° / 5.24%				
	1.25	2	3	4	5
THR	1.25	2	3	4	5
ALTITUDE	580	820	1140	1460	1780

MISSED APPROACH RNP
Climb to 2000 ft on track 282° to SP28W and join Holding WEST.

Non-RNP: Climb to 2000 FT on SKR R-282 to 6 DME and join Holding WEST.

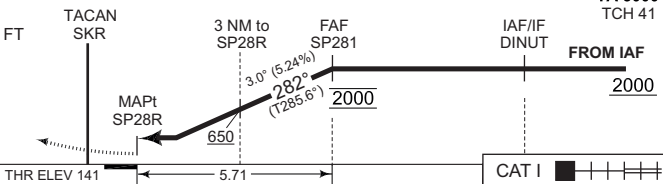

CATEGORY	A	B	C	D	E
LNAV (MDA)	580 - 1300 439 (500-1.3/1.5)		580 - 1300 439 (500-1.3/2.0)		
CIRCLING	630 - 1.5 489 (500-1.5)	700 - 1.6 559 (600-1.6)	800 - 2.4 659 (700-2.4)	890 - 3.6 749 (800-3.6)	1490 - 3.6 1349 (1400-3.6)

RNP RWY 28R

55°13.53'N
009°15.84'E

SKRYDSTRUP (EKSP)

CHANGES: MAG VAR CORRECTED. MULTIPLE COURSES CORRECTED.

MIPS

AIR COMMAND DENMARK - MIL AIM 19 FEB 2028

EKSP RNP RWY 28R waypoint coordinates:

RWY 28R from BURUX (Initial LEFT) APPROACH RNP

		CODING		DISPLAY
BURUX	IAF	55 05 00.81N	009 37 08.16E	55 05.014N 009 37.136E
DINUT	IAF/IF	55 09 59.00N	009 36 29.00E	55 09.983N 009 36.483E
SP281	FAF	55 11 31.71N	009 26 54.61E	55 11.529N 009 26.910E
SP28R	MAPt	55 13 02.67N	009 17 22.11E	55 13.045N 009 17.369E
SP28W	MAHF	55 14 59.44N	009 04 59.24E	55 14.991N 009 04.987E

RWY 28R from OLUTU (Initial RIGHT) APPROACH RNP

		CODING		DISPLAY
OLUTU	IAF	55 14 02.63N	009 41 35.27E	55 14.044N 009 41.588E
DINUT	IAF/IF	55 09 59.00N	009 36 29.00E	55 09.983N 009 36.483E
SP281	FAF	55 11 31.71N	009 26 54.61E	55 11.529N 009 26.910E
SP28R	MAPt	55 13 02.67N	009 17 22.11E	55 13.045N 009 17.369E
SP28W	MAHF	55 14 59.44N	009 04 59.24E	55 14.991N 009 04.987E

Threshold coordinates RWY 28R

		CODING		DISPLAY
RWY 28R		55 13 02.67N	009 17 22.11E	55 13.045N 009 17.369E

**MIPS
AERODROME CHART**

TORP(ENTO)

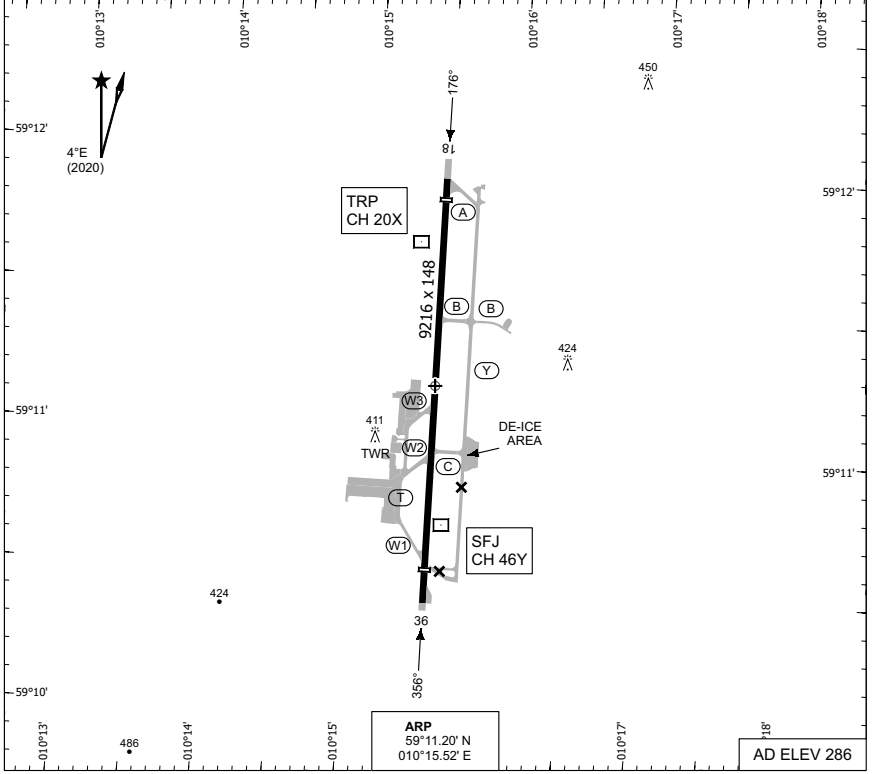

RWY	PCN	TORA	ASDA	TODA	LDA	PAPI	THR ELEV	THR PSN
18	45/F/B/X/U	8494	8494	9380	8035	3.0°	282	59°11.86' N - 010°15.50' E
36	45/F/B/X/U	8757	8757	9642	8035	3.0°	255	59°10.54' N - 010°15.53' E

ATIS 119.080
TORP GND 126.180
TORP TWR 118.655

PROC. CRITERIA	RWY	GS	TCH	OTCH	RPI	CAT	MINIMA CRITERIA	MINIMA

AERODROME CHART

TORP(ENTO)

CHANGE: PERIODIC REVIEW

RNAAF 30 OCT 2025

AERODROME CHART

VIGRA (ENAL)

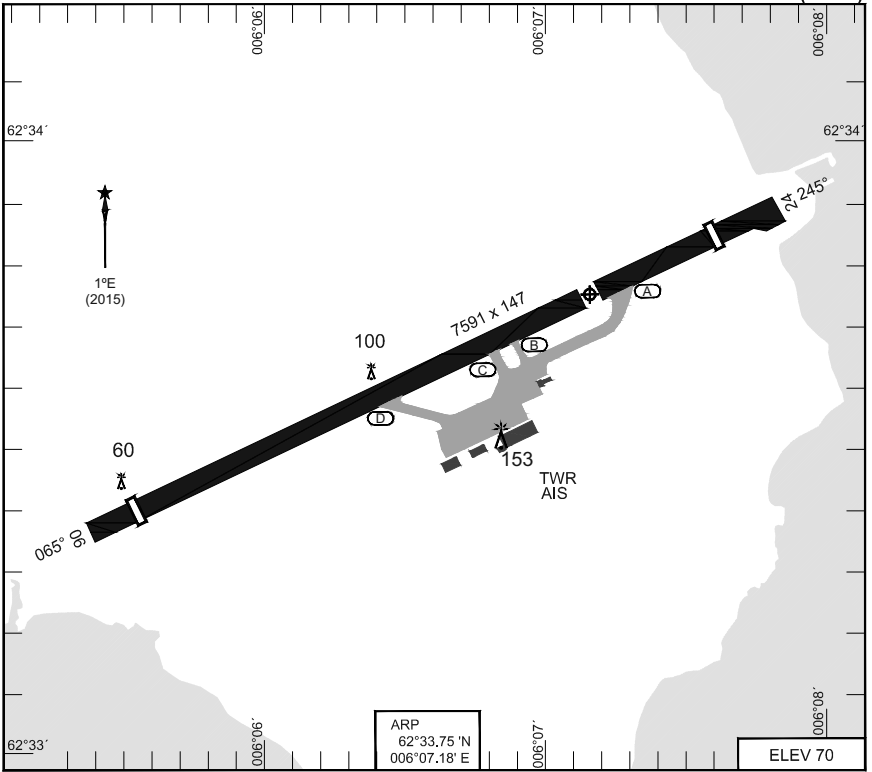

ARP
62°33.75' N
006°07.18' E

ELEV 70

RWY	PCN	TORA	ASDA	TODA	LDA	PAPI	TDZE	THR PSN
07	40 F/C/X/U	7099	7099	7591	6607	3.0°	67	62°33.39' N - 006°05.55' E
25	40 F/C/X/U	7591	7591	7739	6833	3.0°	69	62°33.84' N - 006°07.59' E

ATIS 128.650
VIGRA TWR 118.100

	PROC. CRITERIA	RWY	GS	TCH	OTCH	RPI	CAT	MINIMA CRITERIA	MINIMA

CHANGES: EDITORIAL

RNAAF 08 AUG 2024

AERODROME CHART

VIGRA (ENAL)

CORNFIELD 291.650	DUTCH MIL INFO 341.600 132.350	
----------------------	-----------------------------------	--

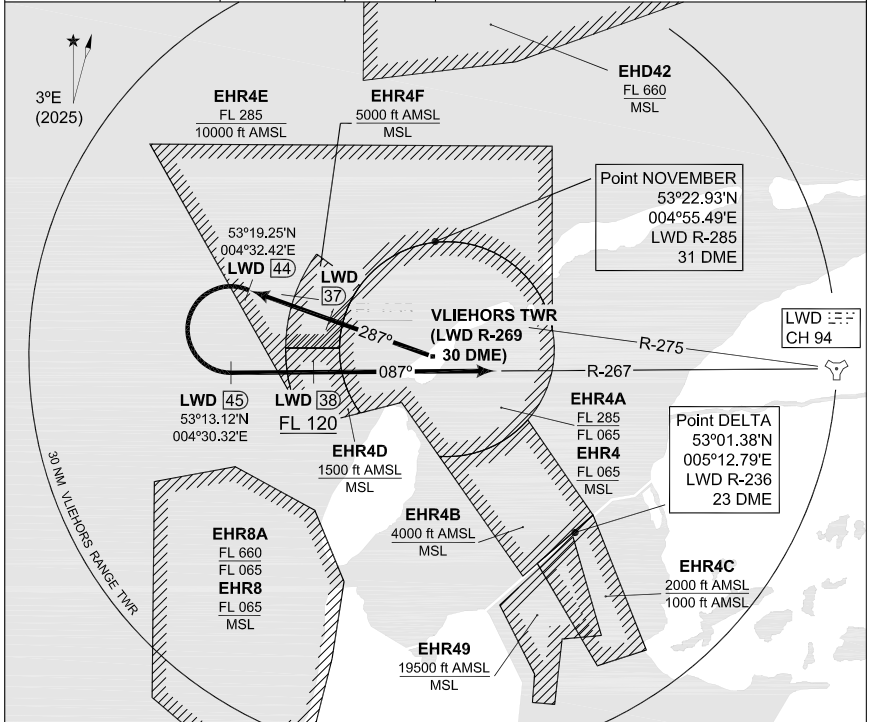

NOTES:

- Upper limit of Vliehors Range FL 285.
- GCA/TACAN traffic into EHLW may cross at or near point Delta at or above 2000 ft AMSL.

VL 1 TEARDROP IFR DEPARTURE	Following final delivery, proceed outbound on heading 287° from the tower, climbing to FL 120 or above. At 37 DME from LWD TACAN, FL 055 has to be reached. Proceed outbound to 15 NM from the range (LWD TACAN R-275/44 DME) and turn left to intercept LWD R-267 inbound. When cleared to leave the range frequency and established on the departure, contact Dutch Mil. Flight members will follow in sequence. When contact with Dutch Mil and at FL 120 or above, it is permitted to turn inbound before reaching LWD R-275/44 DME.
IMMELMANN IFR DEPARTURE	Departing aircraft may perform an Immelmann manoeuvre (under VMC only) to become established inbound on LWD R-267. Further see above.
LOW LEVEL IFR DEPARTURE (Northern based FRG acft only)	Leave via point NOVEMBER to 53°42'N 006°52'E at 3000 ft AMSL (day) or 2000 ft AMSL (night). Stay clear of all islands by 2 NM and do not leave the Range airspace until cleared by Dutch Mil.
HIGH LEVEL IFR DEPARTURE	To leave the Vliehors Range between 20000 ft and FL 285, stay within the lateral limits of the Range until cleared by Dutch Mil (CH 6). Only when proceeding inbound the EHD01-09 a direct call to 'Bandbox Main' is approved. Also stay within the lateral limits of the Range until cleared by 'Bandbox'.

CHANGES: EDITORIAL

RNLASF 16 APR 2026

CORNFIELD 291.650	DUTCH MIL INFO 341.600 132.350	
----------------------	-----------------------------------	--

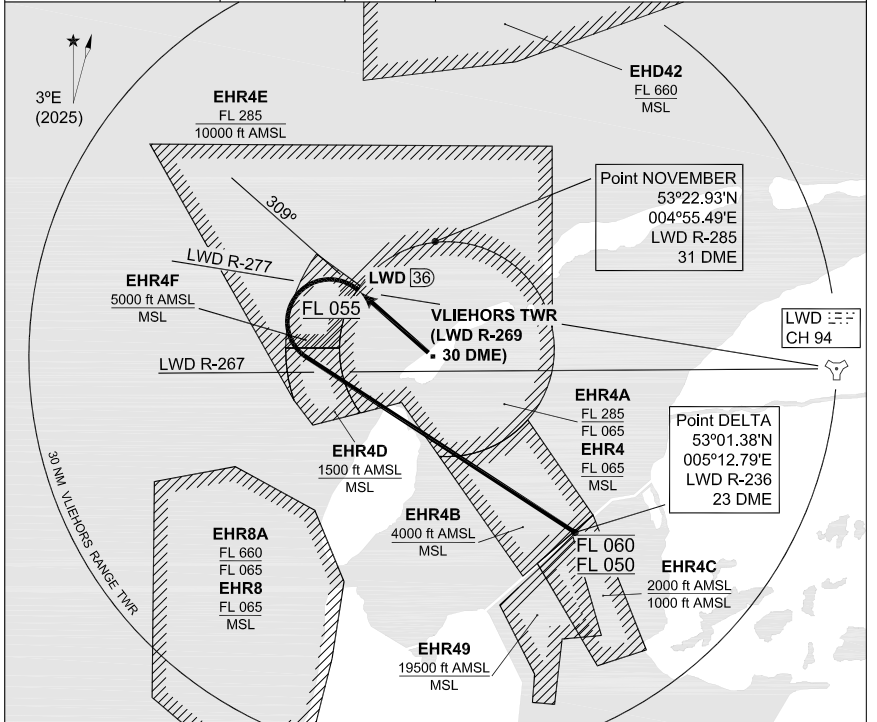

NOTES:

- Upper limit of Vliehors Range FL 285.
- GCA/TACAN traffic into EHLW may cross at or near point Delta at or above 2000 ft AMSL.

VL 2 TEARDROP IFR DEPARTURE	Following final delivery, proceed outbound on heading 309° from the tower, climbing to max. FL 060. When passing LWD R-277 FL 055 has to be reached and turn left inbound point DELTA (LWD TACAN R-236/23 DME). Contact Dutch Mil when established on the departure and cleared to leave the range frequency. Contact with Dutch Mil shall be established within the boundary of the EHR4. Flight members will follow in sequence.
IMMELMANN IFR DEPARTURE	Departing aircraft may perform an Immelmann manoeuvre (under VMC only) to become established inbound on LWD R-267. Further see above.
LOW LEVEL IFR DEPARTURE (Northern based FRG acft only)	Leave via point NOVEMBER to 53°42'N 006°52'E at 3000 ft AMSL (day) or 2000 ft AMSL (night). Stay clear of all islands by 2 NM and do not leave the Range airspace until cleared by Dutch Mil.
HIGH LEVEL IFR DEPARTURE	To leave the Vliehors Range between 20000 ft and FL 285, stay within the lateral limits of the Range until cleared by Dutch Mil (CH 6). Only when proceeding inbound the EHD01-09 a direct call to 'Bandbox Main' is approved. Also stay within the lateral limits of the Range until cleared by 'Bandbox'.

CHANGES: EDITORIAL

RNLASF 16 APR 2026

MIPS
AERODROME CHART

VOLKEL (EHVK)

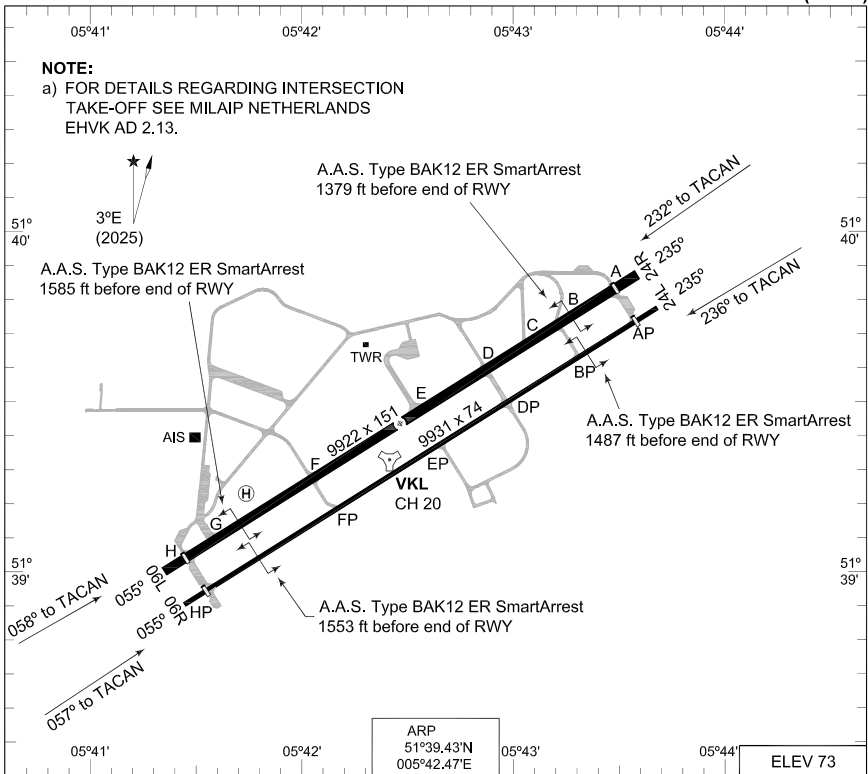

RWY	PCN	TORA	ASDA	TODA	LDA	PAPI	THR ELEV	THR PSN
24R	30 R/B/W/T	9922	9922	9922	9498	3.0°	62	51°39,83'N 005°43,49'E
06L	30 R/B/W/T	9922	9922	9922	9500	3.0°	72	51°39,04'N 005°41,45'E
24L	27 R/B/W/T	9931	9931	9931	9487	3.0°	62	51°39,73'N 005°43,58'E
06R	27 R/B/W/T	9931	9931	9931	9485	3.0°	73	51°38,94'N 005°41,55'E

* SWY 24L PCN 16 R/B/W/T, SWY 06R 17 R/B/W/T
 VOLKEL TWR 291.100 136.080 (Ground Control) 386.775
 VOLKEL ARRIVAL 291.200
 RAPCON SOUTH 388.525 123.180

SRA	PROC. CRITERIA	RWY	GS	TCH	OTCH	RPI	CAT	MINIMA CRITERIA	MINIMA
	MIPS	24R					ABCDE	MIPS	460-1100 398 (400-1.1/1.8)
	MIPS	24L					ABCDE	MIPS	460-1400 398 (400-1.4/1.8)
	MIPS	06L					ABCDE	MIPS	460-1100 388 (400-1.1/1.8)
	MIPS	06R					ABCDE	MIPS	460-1400 387 (400-1.4/1.8)

AERODROME CHART

VOLKEL (EHVK)

CHANGES: EDITORIAL

RNLASF 16 APR 2026

**MIPS
INSTRUMENT DEPARTURE CHART**

AD ELEV 73

**VK1
VOLKEL (EHVK)**

GND CTL 386.775	VOLKEL TWR 291.100 136.080	RAPCON SOUTH 388.525 123.180				DUTCH MIL 336.325 125.930			
		RWY 24	Knots V/V (fpm)	120 540	180 810	240 1070	300 1340	360 1610	to 400 ft

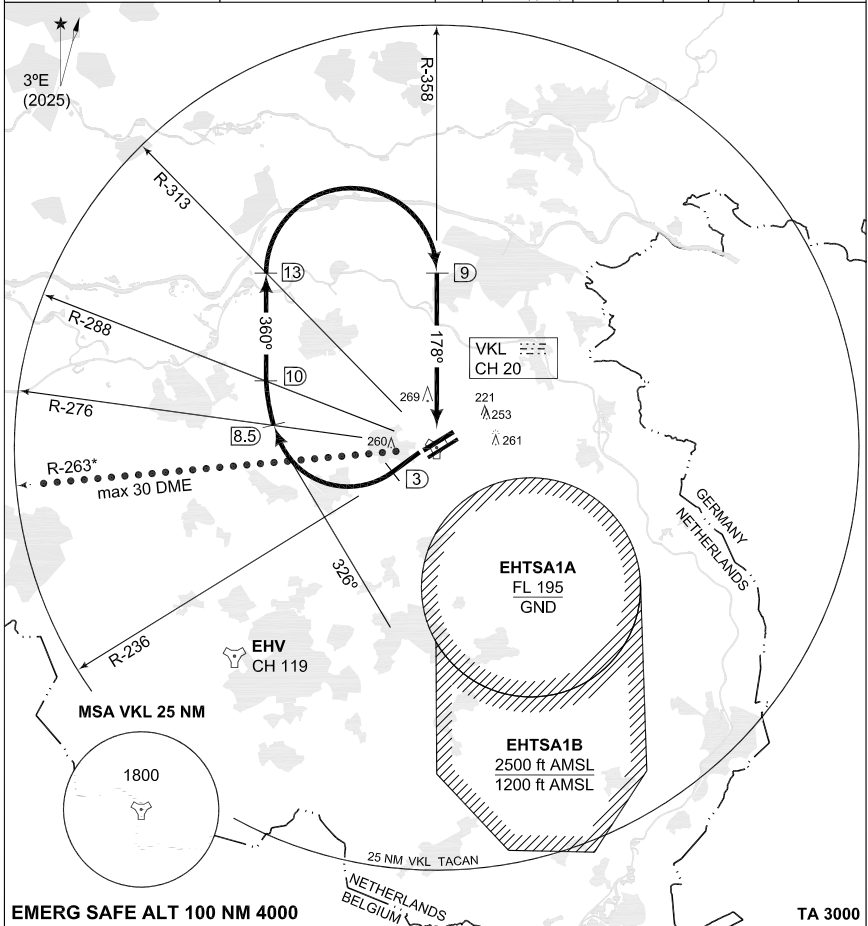

EMERG SAFE ALT 100 NM 4000

TA 3000

**VOLKEL 1
(RWY 14)**

- Climb straight ahead to 3 DME from Volkel TACAN.
- Turn right, heading 326°.
- When passing R-276 turn right, heading 360°.
- When passing R-313 turn right (remain within 20 DME) to intercept R-358 inbound.
- * Afterburner climb not approved until cleared by ATC. When cleared climb on R-263 outbound max. to 30 DME.

NOTE:

Departure end crossing height: RWY 24R: 39 ft; RWY 24L: 24 ft.

CHANGES: EDITORIAL

RNLASF: 16 APR 2026

VK1

51°39.43'N
005°42.47'E

VOLKEL (EHVK)

**MIPS
INSTRUMENT DEPARTURE CHART**

AD ELEV 73

**VK2
VOLKEL (EHVK)**

GND CTL 386.775	VOLKEL TWR 291.100 136.080	RAPCON SOUTH 388.525 123.180				DUTCH MIL 336.325 125.930			
		RWY 24	Knots V/V (fpm)	120 540	180 810	240 1070	300 1340	360 1610	to 400 ft

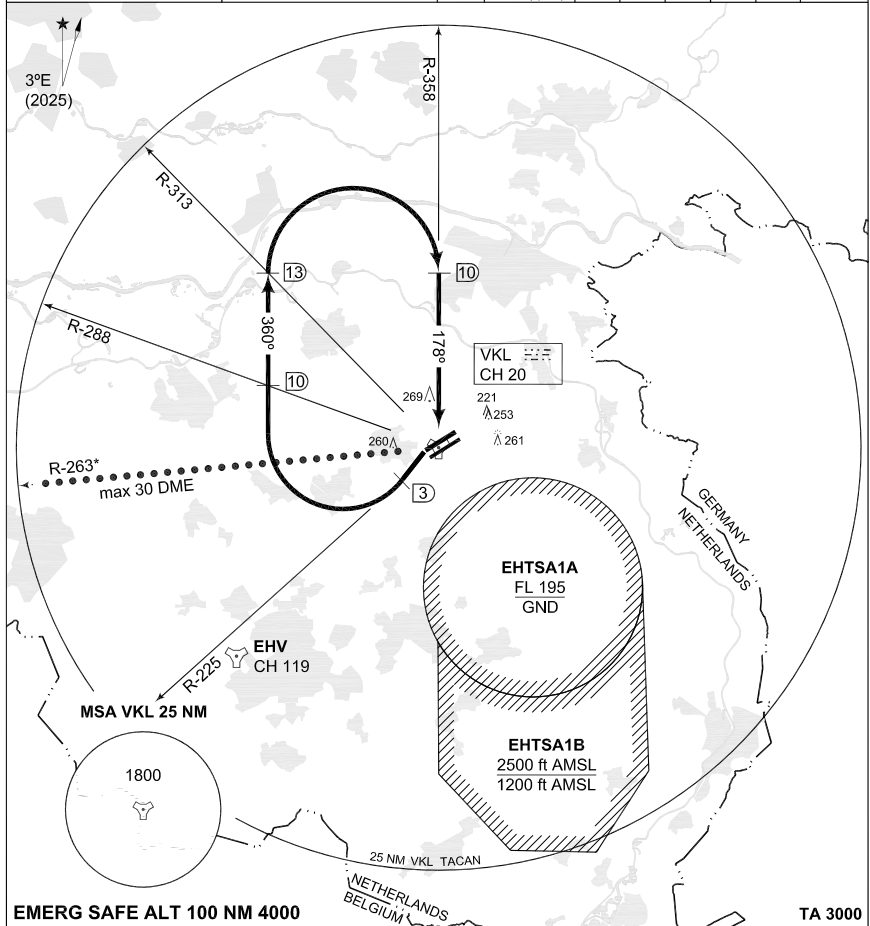

EMERG SAFE ALT 100 NM 4000

TA 3000

**VOLKEL 2
(RWY 24)**

- Climb and turn left to intercept R-225.
- At 3 DME turn right, heading 360°.
- When passing R-313 turn right (remain within 20 DME) to intercept R-358 inbound.
- * Afterburner climb not approved until cleared by ATC. When cleared climb on R-263 outbound max. to 30 DME.

NOTE:

Departure end crossing height: RWY 24R: 39 ft; RWY 24L: 24 ft.

CHANGES: EDITORIAL

VK2

51°39.43'N
005°42.47'E

VOLKEL (EHVK)

RNLASF: 16 APR 2026

**MIPS
INSTRUMENT DEPARTURE CHART**

**VK3
VOLKEL (EHVK)**

AD ELEV 73

GND CTL 386.775	VOLKEL TWR 291.100 136.080	RAPCON SOUTH 388.525 123.180		DUTCH MIL 336.325 125.930					
		RWY 06	Knots V/V (fpm)	120 1440	180 2160	240 2880	300 3600	360 4320	to 100 ft

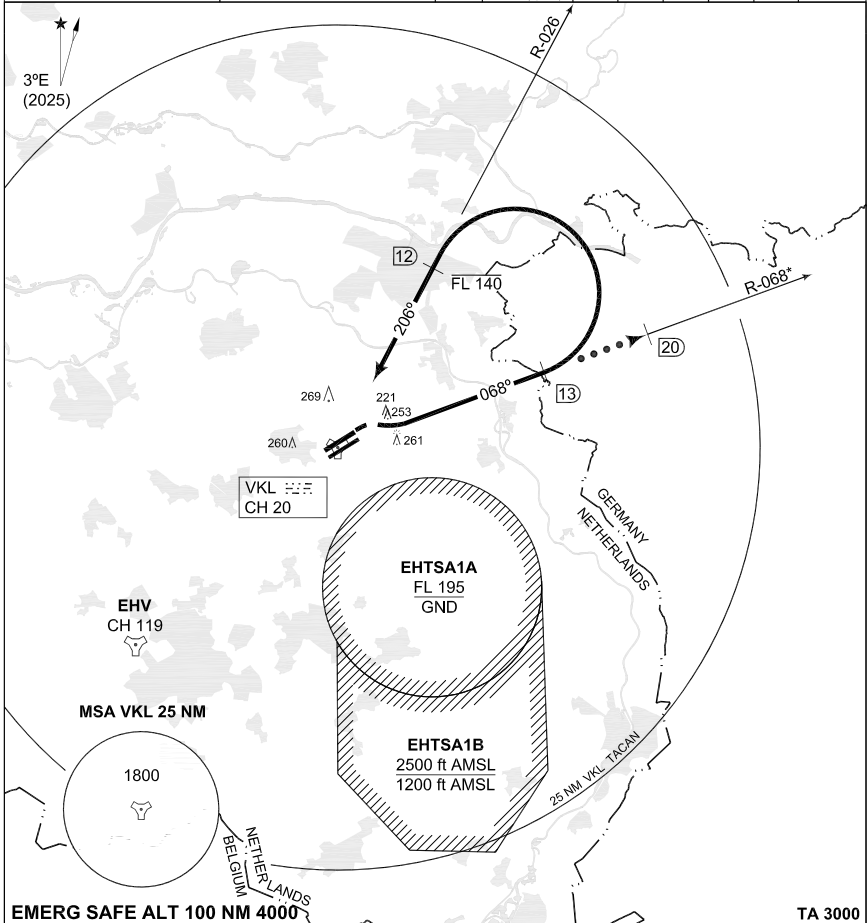

EMERG SAFE ALT 100 NM 4000

TA 3000

**VOLKEL 3
(RWY 06)**

- Intercept and proceed outbound on R-068 from Volkkel TACAN, climb to FL 140.
- At 13 DME turn left (remain within 20 DME) to intercept R-026 inbound.
- When passing 12 DME on R-026 inbound continue climb.
- * Afterburner climb not approved until cleared by ATC. When cleared climb on R-068 outbound max. to 20 DME.

NOTE: - Departure end crossing height: RWY 06L: 17 ft; RWY 06R: 23 ft.

CHANGES: EDITORIAL

RNLASF: 16 APR 2026

VK3

51°39.43'N
005°42.47'E

VOLKEL (EHVK)

**MIPS
INSTRUMENT DEPARTURE CHART**

**VK6
VOLKEL (EHVK)**

AD ELEV 73

GND CTL 386.775		VOLKEL TWR 291.100 136.080		RAPCON SOUTH 388.525 123.180				DUTCH MIL 336.325 125.930			
				RWY	Knots	120	180	240	300	360	to
				24	V/V (fpm)	540	810	1070	1340	1610	400 ft

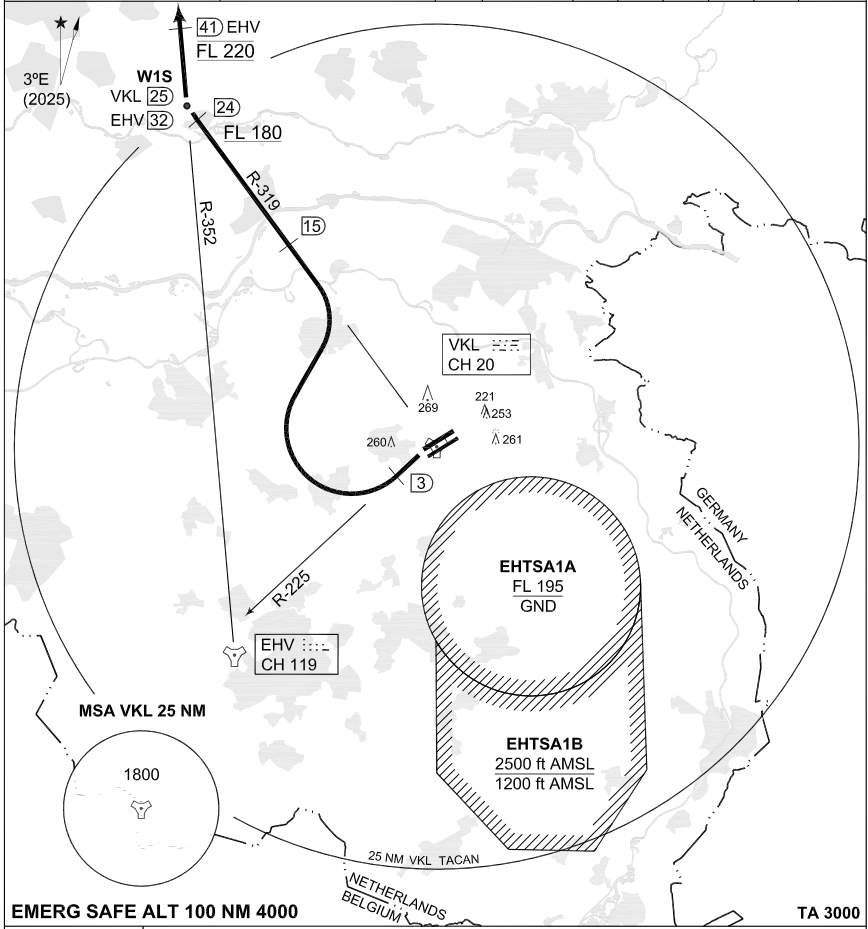

EMERG SAFE ALT 100 NM 4000

TA 3000

**VOLKEL 6
(RWY 24)**

- Climb and turn left to intercept R-225.
- At 3 DME turn right to intercept R-319 outbound.
- Cross R-319 outbound, 24 DME at FL 180 or above.
- At 24 DME turn right to intercept EHV R-352.
- Cross EHV R-352/41 DME at FL 220, unless instructed otherwise by ATC.

NOTES:

- Departure end crossing height: RWY 24R: 39 ft; RWY 24L: 24 ft.
- If no radiocontact with Dutch Mil at 15 DME turn right inbound VKL TACAN and contact RAPCON SOUTH.

CHANGES: EDITORIAL

RNLASF: 16 APR 2026

VK6

51°39.43'N
005°42.47'E

VOLKEL (EHVK)

**MIPS
INSTRUMENT DEPARTURE CHART**

AD ELEV 73

**VK7
VOLKEL (EHVK)**

GND CTL 386.775	VOLKEL TWR 291.100 136.080	RAPCON SOUTH 388.525 123.180				DUTCH MIL 336.325 125.930			
		RWY 06	Knots V/V (fpm)	120 1440	180 2160	240 2880	300 3600	360 4320	to 100 ft

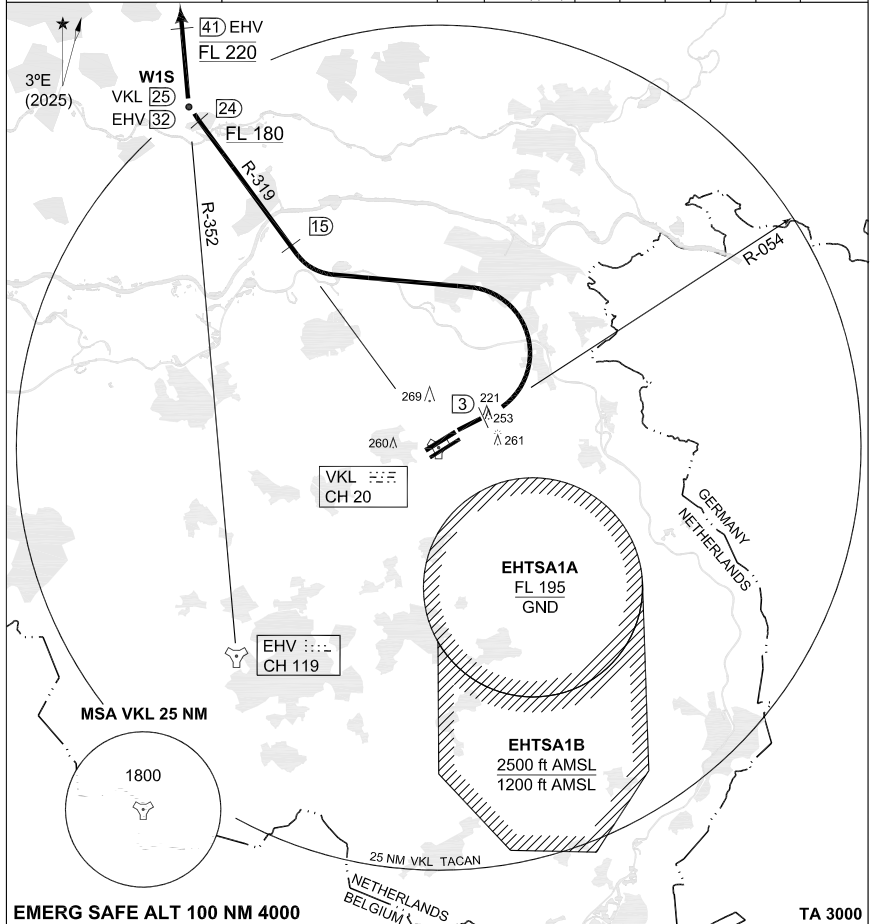

EMERG SAFE ALT 100 NM 4000

TA 3000

**VOLKEL 7
(RWY 06)**

- Climb straight ahead to 3 DME from Volkels TACAN.
- Turn left to intercept R-319 outbound.
- Cross R-319 outbound, 24 DME at FL 180 or above.
- At 24 DME turn right to intercept EHV R-352.
- Cross EHV R-352/41 DME at FL 220, unless instructed otherwise by ATC.

NOTE:

- Departure end crossing height: RWY 06L: 17 ft; RWY 06R: 23 ft.
- If no radiocontact with Dutch Mil at 15 DME turn right inbound VKL TACAN and contact RAPCON SOUTH.

CHANGES: EDITORIAL

RNLASF: 16 APR 2026

VK7

51°39.43'N
005°42.47'E

VOLKEL (EHVK)

MIPS
INSTRUMENT APPROACH CHART

ILS or LOC RWY 06L
VOLKEL (EHVK)

AD ELEV 73

DUTCH MIL 336.325 125.930		RAPCON SOUTH 388.525 123.180		VOLKEL TWR 291.100 136.080		GND CTL 386.775	
LOCALIZER / DME VLZ 110.750 / CH 44 Y		APP COURSE 055°	GS INTCP ALT 1500 FT	GS 3°	DA 272	THR ELEV 72	ALS 880 m
						LDA 06L-9500 FT	

CAUTION:

a) DO NOT MANOEUVRE SOUTH OF R-235

NOTE:

- b) CIRCLING ONLY ALLOWED FOR HOMEBASE ACFT
- c) CIRCLING NOT AUTHORIZED NORTH OF RWY 06L - 24R

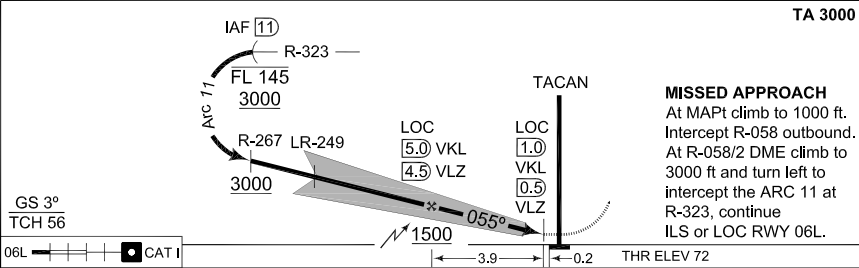
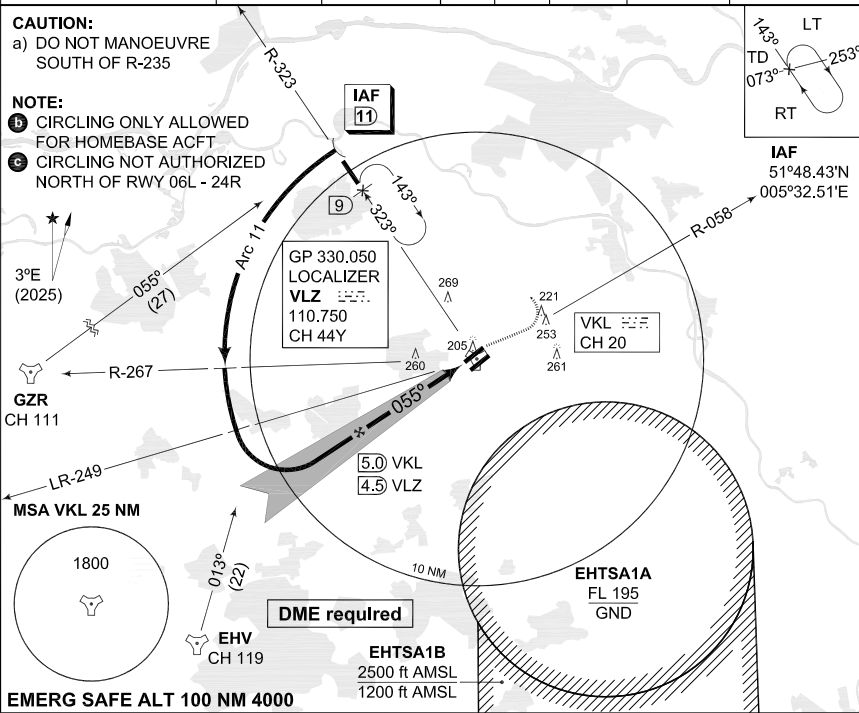

CATEGORY	A	B	C	D	E
S-ILS 06L	272-800 200 (200-0.8/1.6)				
S-LOC 06L	370-800 298 (300-0.8/1.6)		370-1200 298 (300-1.2/1.6)		
CIRCLING	500-1900 427 (500-1.9)	570-2800 497 (500-2.8)	790-3700 717 (800-3.7)	790-4600 717 (800-4.6)	890-6500 817 (900-6.5)

ILS or LOC RWY 06L

51°39.43'N
005°42.47'E

VOLKEL (EHVK)

CHANGES: EDITORIAL

MIPS

RNLASF 16 APR 2026

MIPS
INSTRUMENT APPROACH CHART

TACAN RWY 06L - 06R
VOLKEL (EHVK)

AD ELEV 73

DUTCH MIL 336.325 125.930		RAPCON SOUTH 388.525 123.180		VOLKEL TWR 291.100 136.080		GND CTL 386.775
TACAN VKL CH 20	APP COURSE 058°	FAF ALT 1500 FT	Descent GR	DA 430	THR ELEV 72	ALS 06L-880 m/06R-420m
					LDA 06L-9500 FT/06R-9485 FT	

CAUTION:

a) DO NOT MANOEUVRE SOUTH OF R-235

NOTE:

- b) RWY 06R FINAL RADIAL 238
- c) CIRCLING ONLY ALLOWED FOR HOMEBASE ACFT
- d) CIRCLING NOT AUTHORIZED NORTH OF RWY 06L-24R

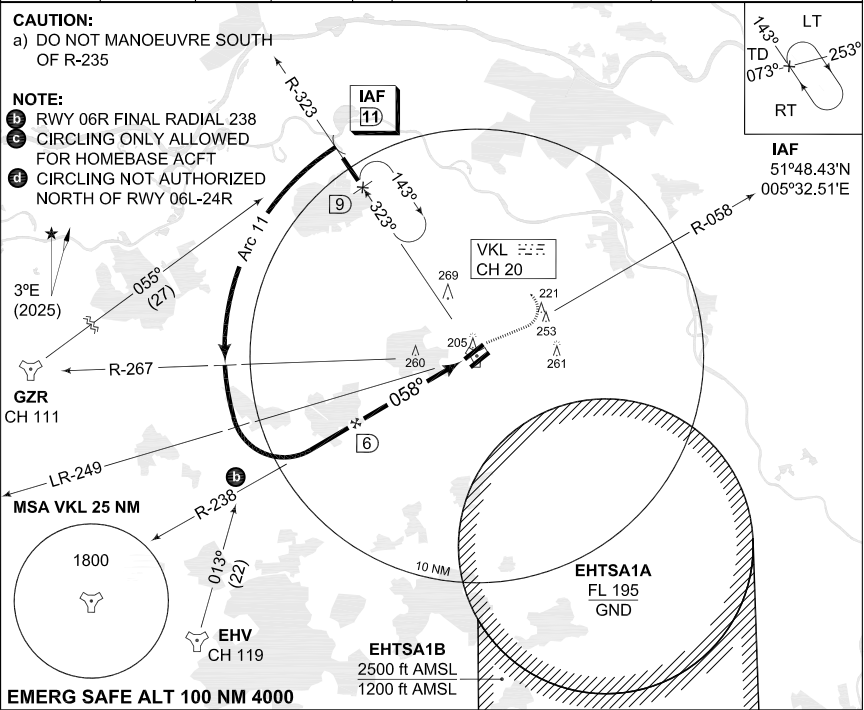

EMERG SAFE ALT 100 NM 4000

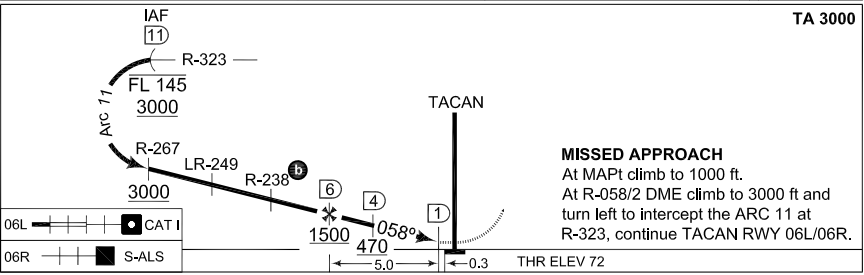

CATEGORY	A	B	C	D	E
S-TAC 06L	430-800 358 (400-0.8/1.6)		430-1200 358 (400-1.2/1/6)	430-1200 358 (400-1.2/2.0)	
S-TAC 06R	430-1200 358 (400-1.2/1.6)			430-1600 358 (400-1.6/2.0)	
CIRCLING (c-d)	500-1900 427 (500-1.9)	570-2800 497 (500-2.8)	790-3700 717 (800-3.7)	790-4600 717 (800-4.6)	890-6500 817 (900-6.5)

TACAN RWY 06L - 06R

51°39.43'N
005°42.47'E

VOLKEL (EHVK)

CHANGES: EDITORIAL

MIPS

RNLASF 16 APR 2026

MIPS
INSTRUMENT APPROACH CHART

ILS or LOC RWY 24R
VOLKEL (EHVK)

AD ELEV 73

DUTCH MIL 336.325 125.930		RAPCON SOUTH 388.525 123.180		VOLKEL TWR 291.100 136.080		GND CTL 386.775		
LOCALIZER / DME VLO 110.750 / CH 44 Y		APP COURSE 235°	GS INTCP ALT 1500 FT	GS 3°	DA 262	THR ELEV 62	ALS 852 m	LDA 24R-9498 FT

CAUTION:

a) DO NOT MANOEUVRE SOUTH OF R-058

NOTE:

- b** CIRCLING ONLY ALLOWED FOR HOMEBASED ACFT CIRCLING
- c** NOT AUTHORIZED NORTH OF RWY 06L-24R

3°E
(2025)

GZR
CH 111

MSA VKL 25 NM

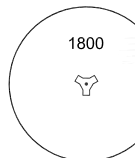

EMERG SAFE ALT 100 NM 4000

GP 330.050
LOCALIZER
VLO
110.750
CH 44 Y

VKL
CH 20

DME required

EHTSA1B
2500 ft AMSL
1200 ft AMSL

EHTSA1A
FL 195
GND

IAF
51°51.43'N
005°50.00'E

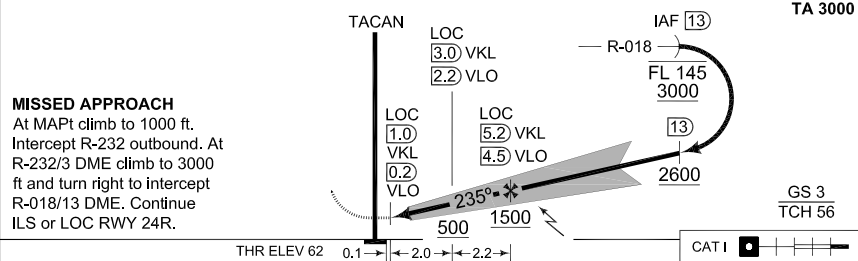
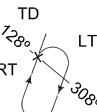

MISSED APPROACH

At MAPt climb to 1000 ft.
Intercept R-232 outbound. At
R-232/3 DME climb to 3000
ft and turn right to intercept
R-018/13 DME. Continue
ILS or LOC RWY 24R.

THR ELEV 62	0.1	← 2.0	← 2.2	CAT I
-------------	-----	-------	-------	-------

CATEGORY	A	B	C	D	E
S-ILS 24R	262-800 200 (200-0.8/1.6)				
S-LOC 24R	440-800 378 (400-0.8/1.6)		440-1200 378 (400-1.2/1.6)	440-1200 378 (400-1.2/2.0)	
CIRCLING	500-1900 427 (500-1.9)	570-2800 497 (500-2.8)	790-3700 717 (800-3.7)	790-4600 717 (800-4.6)	890-6500 817 (900-6.5)

ILS or LOC RWY 24R

51°39.43'N
005°42.47'E

VOLKEL (EHVK)

CHANGES: EDITORIAL

RNLASF 16 APR 2026

MIPS
INSTRUMENT APPROACH CHART

TACAN RWY 24R - 24L
VOLKEL (EHVK)

AD ELEV 73

DUTCH MIL 336.325 125.930		RAPCON SOUTH 388.525 123.180		VOLKEL TWR 291.100 136.080		GND CTL 386.775
TACAN VKL CH 20	APP COURSE 232°	FAF ALT 1500 FT	Descent GR	DA 440	THR ELEV 62	ALS 24R-852 m / 24L-423 m
						LDA 24R-9498FT/24L-9487FT

CAUTION:

DO NOT MANOEUVRE SOUTH OF R-058

NOTE:

- ⓑ RWY 24L FINAL RADIAL 056
- ⓒ CIRCLING ONLY ALLOWED FOR HOMEBASED ACFT
- ⓓ CIRCLING NOT AUTHORIZED NORTH OF RWY 06L-24R

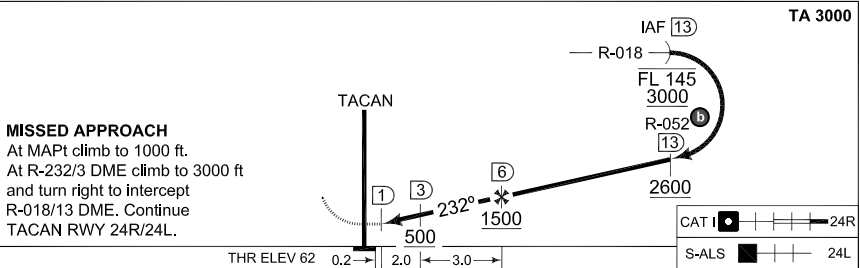
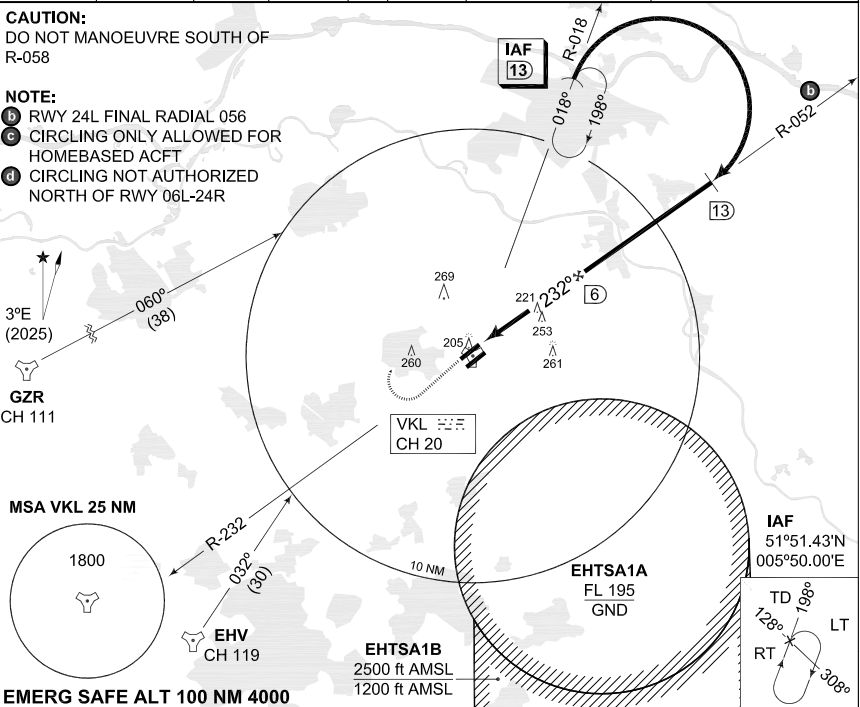

CATEGORY	A	B	C	D	E
S-TACAN 24R	440-800 378 (400-0.8/1.6)		440-1200 378 (400-1.2/1.6)	440-1200 378 (400-1.2/2.0)	
S-TACAN 24L	440-1200 378 (400-1.2/1.6)			440-1600 378 (400-1.6/2.0)	
CIRCLING ⓐ ⓓ	500-1900 427 (500-1.9)	570-2800 497 (500-2.8)	790-3700 717 (800-3.7)	790-4600 717 (800-4.6)	890-6500 817 (900-6.5)

TACAN RWY 24R - 24L

51°39.43'N
005°42.47'E

VOLKEL (EHVK)

CHANGES: EDITORIAL

RNLASF 16 APR 2026

**MIPS
AERODROME CHART**

WOENSDRECHT (EHWO)

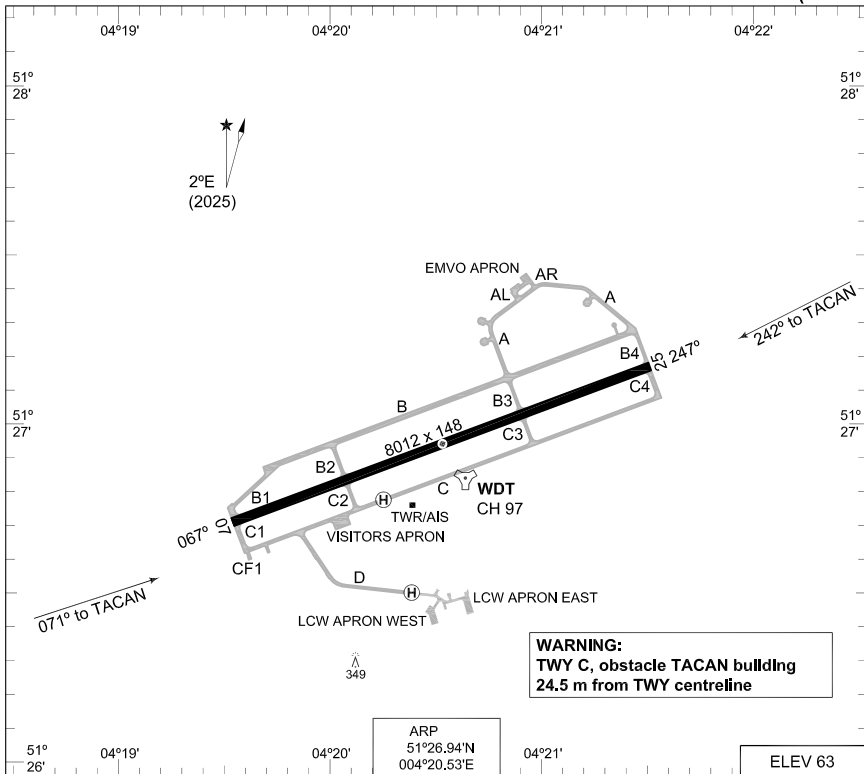

WARNING:
TWY C, obstacle TACAN building
24.5 m from TWY centreline

ARP
51°26.94'N
004°20.53'E

ELEV 63

RWY	PCN	PCR	TORA	ASDA	TODA	LDA	PAPI	THR ELEV	THR PSN
25	51 R/C/W/T	564 R/C/W/T	8012	8012	8208	8012	3.0°	63	51°27.17'N 004°21.51'E
07	51 R/C/W/T	564 R/C/W/T	8012	8012	8208	8012	3.0°	39	51°26.71'N 004°19.54'E

GROUND CONTROL 356.875 121.680
 WOENSDRECHT TWR 339.000 120.430
 RAPCON WEST 399.725 123.580
 WOENSDRECHT ARRIVAL 370.650

SRA	PROC. CRITERIA	RWY	GS	TCH	OTCH	RPI	CAT	MINIMA CRITERIA	MINIMA
	MIPS	25					AB	MIPS	450-1100 387 (400-1.1)
	MIPS	07					CDE	MIPS	450-1200 387 (400-1.2)
							AB		600-1600 561 (600-1.6)
							C		600-2400 561 (600-2.4)
							D		600-2800 561 (600-2.8)
							E		600-3200 561 (600-3.2)

CHANGES: EDITORIAL

RELEASE 16 APR 2026

AERODROME CHART

WOENSDRECHT (EHWO)

**MIPS
INSTRUMENT DEPARTURE CHART**

WO1

AD ELEV 63

WOENSDRECHT (EHWO)

GND CTL 356.875 121.680		WOENSDRECHT TWR 339.000 120.430		RAPCON WEST 399.725 123.580				DUTCH MIL 336.325 125.930			
RWY	25	Knots	V/V (fpm)	120	180	240	300	360	1080	to	114 ft

NOTE:
Ⓜ WHEN IN ARC 9, DO NOT EXCEED 10 DME

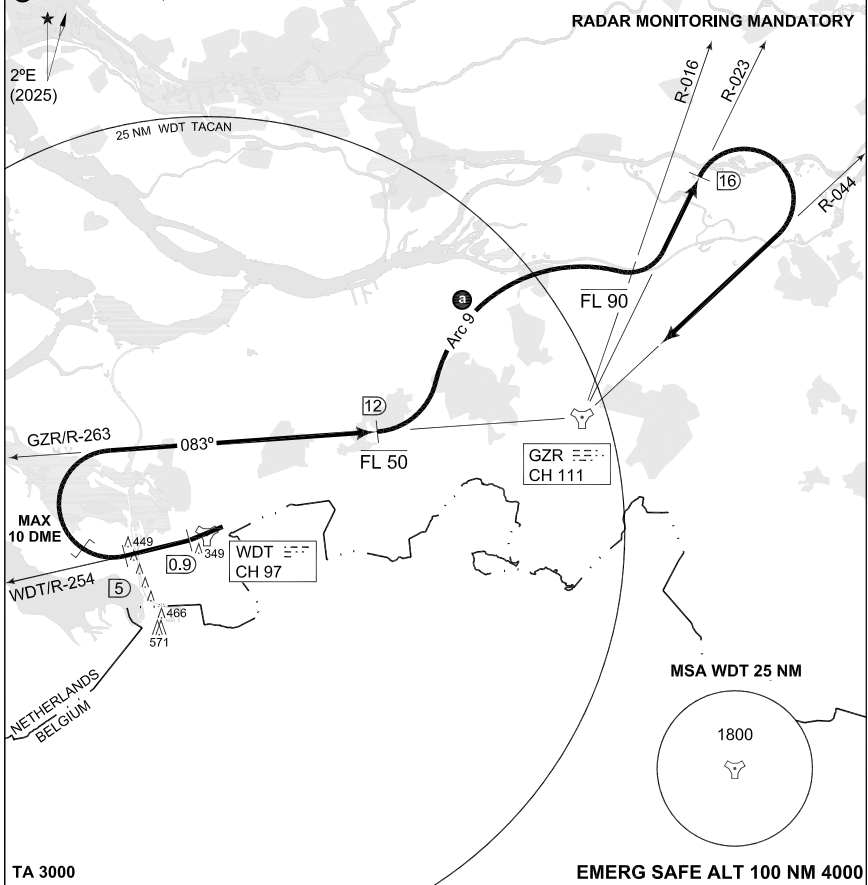

TA 3000

EMERG SAFE ALT 100 NM 4000

CAUTION: Dep end crossing height 78 ft due to obstacle left of centerline. TORA 8014.

**WOENSDRECHT 1
(RWY 25)**

- At 0.9 DME intercept R-254 outbound, level off at FL 50.
- At 5 DME intercept GZR R-263 inbound.
- At R-263/12 DME climb to FL 90.
- Turn left to intercept Arc 9. Ⓜ
- Intercept R-023 outbound, when crossing GZR R-016 continue climb.
- At 16 DME turn right to intercept R-044 inbound.

NOTE: Departure will be controlled by Rapcon West.

CHANGES: EDITORIAL

RNLASF 16 APR 2026

WO1

51°26.94'N
004°20.53'E

WOENSDRECHT (EHWO)

MIPS
INSTRUMENT DEPARTURE CHART

WO3

AD ELEV 63

WOENSDRECHT (EHWO)

GND CTL 356.875 121.680	WOENSDRECHT TWR 339.000 120.430	RAPCON WEST 399.725 123.580	DUTCH MIL 336.325 125.930
----------------------------	------------------------------------	--------------------------------	------------------------------

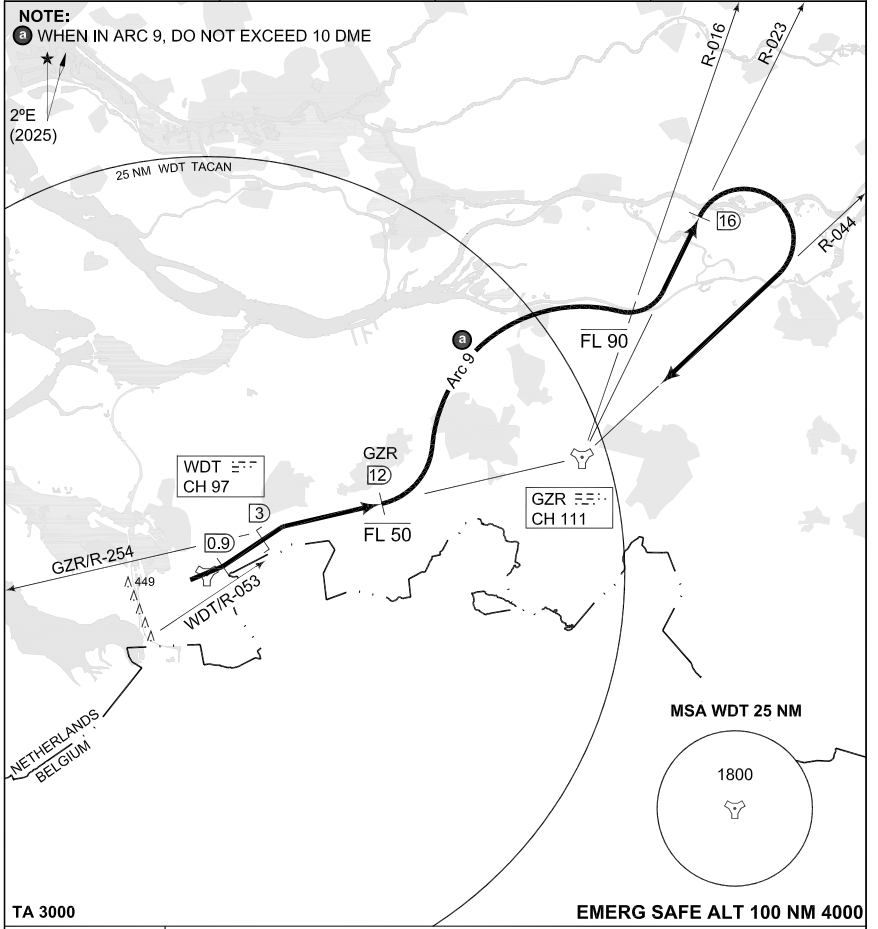

- WOENSDRECHT 3 (RWY 07)**
- At 0.9 DME turn left to intercept WDT R-053 outbound.
 - At 3 DME intercept GZR R-254 inbound, level off at FL 50.
 - At GZR R-254/12 DME climb to FL 90.
 - Turn left to intercept Arc 9. (a)
 - Intercept GZR R-023 outbound, when crossing GZR R-016 continue climb.
 - At 16 DME turn right to intercept R-044 inbound.

NOTE: Departure will be controlled by Rapcon West.

CHANGES: EDITORIAL

RNLASF 16 APR 2026

WO3

51°26.94'N
004°20.53'E

WOENSDRECHT (EHWO)

MIPS
INSTRUMENT APPROACH CHART

AD ELEV 63

ILS or LOC RWY 07
WOENSDRECHT (EHWO)

DUTCH MIL 336.325 125.930		RAPCON WEST 399.725 123.580		WOENSDRECHT TWR 339.000 120.430		GND 356.875 121.680		
TACAN / LOCALIZER / DME WDT CH 97/WDZ 108.150/CH 18Y		APP COURSE 067°	GS INTCP ALT 1500 FT	GS 3°	DA SEE CAT	THR ELEV 39	ALS 420 m	LDA 8012 FT

CAUTION:

- (a)** DURING MISSED APPROACH DO NOT MANOEUVRE SOUTH OF R-066

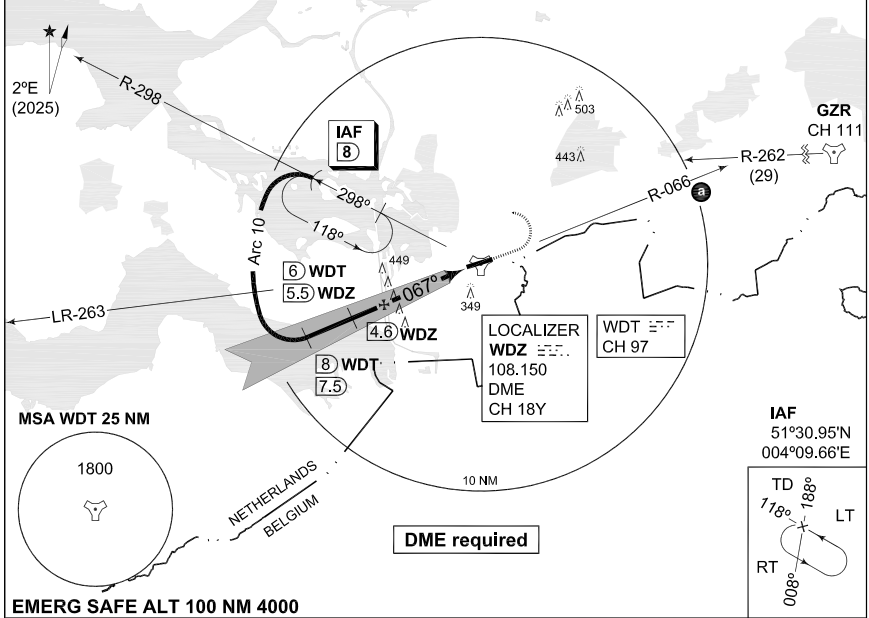

EMERG SAFE ALT 100 NM 4000

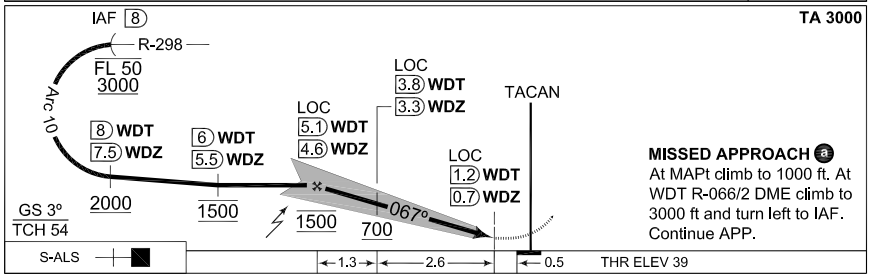

TA 3000

- (b)** MISSED APPROACH: At MAPt climb to 1000 ft. At WDT R-066/2 DME climb to 3000 ft and turn left to IAF. Continue APP.

CATEGORY	A	B	C	D	E
S-ILS 07	239-800 200 (200-0.8)	246-1200 207 (300-1.2)	256-1200 217 (300-1.2)	266-1200 227 (300-1.2)	N.A.
S-LOC 07	480-1600 441 (500-1.6)		480-2000 441 (500-2.0)	480-2400 441 (500-2.4)	N.A.

ILS or LOC RWY 07

51°26.94'N
004°20.53'E

WOENSDRECHT (EHWO)

MIPS
INSTRUMENT APPROACH CHART

HI-TACAN RWY 07
WOENS DRECHT (EHWO)

AD ELEV 63

DUTCH MIL 336.325 125.930		RAPCON WEST 399.725 123.580		WOENS DRECHT TWR 339.000 120.430		GND 356.875 121.680	
TACAN WDT CH 97	APP COURSE 071°	FAF ALT 1200 FT	Descent GR	MDA 600	THR ELEV 39	ALS 420 m	LDA 8012 FT

CAUTION:

1 DURING MISSED APPROACH DO NOT MANOEUVRE SOUTH OF R-066

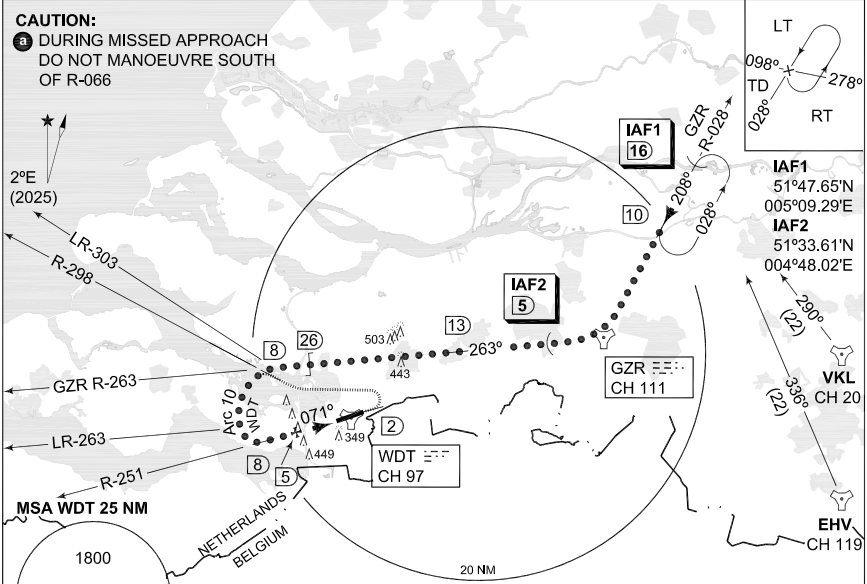

MISSED APPROACH 3

At MAPt climb to 1000 ft.
At R-066/2 DME climb to 3000 ft and turn left to intercept R-298 outbound. At 8 DME turn left to intercept ARC 10. Continue APP.

EMERG SAFE ALT 100 NM 4000

MISSED APPROACH

See above.

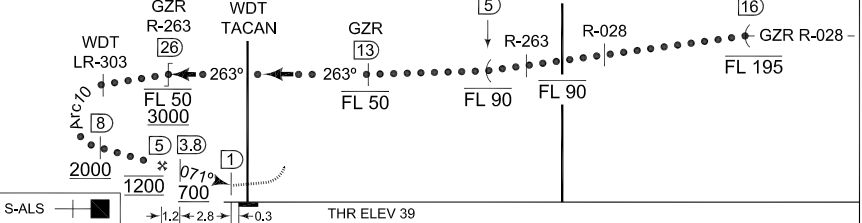

S-ALS 1.2 2.8 0.3 THR ELEV 39

CATEGORY	A	B	C	D	E
S-TACAN 07	600-1600 561 (600-1.6)		600-2400 561 (600-2.4)	600-2800 561 (600-2.8)	600-3200 561 (600-3.2)
CIRCLING	NOT AUTHORIZED				

CHANGES: EDITORIAL MIPS

RNLASF 16 APR 2026

HI-TACAN RWY 07

51°26.94'N
004°20.53'E

WOENS DRECHT (EHWO)

MIPS
INSTRUMENT APPROACH CHART

TACAN RWY 07
WOENSDRECHT (EHWO)

AD ELEV 63

DUTCH MIL 336.325 125.930		RAPCON WEST 399.725 123.580		WOENSDRECHT TWR 339.000 120.430		GND 356.875 121.680	
TACAN WDT CH 97	APP COURSE 071°	FAF ALT 1200 FT	Descent GR	MDA 600	THR ELEV 39	ALS 420 m	LDA 8012 FT

CAUTION:
ⓐ DURING MISSED APPROACH
DO NOT MANOEUVRE SOUTH
OF R-066

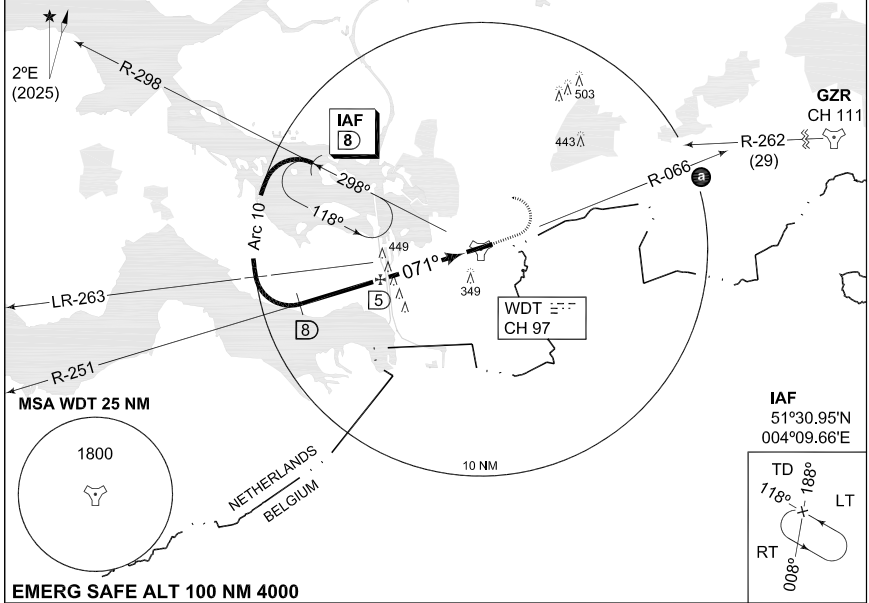

EMERG SAFE ALT 100 NM 4000

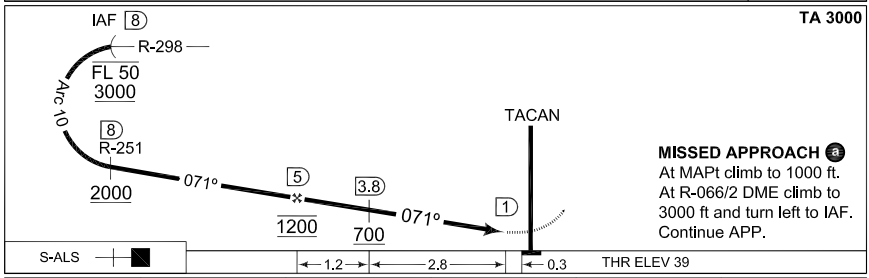

TA 3000

CATEGORY	A	B	C	D	E
S-TACAN 07	600-1600 561 (600-1.6)		600-2400 561 (600-2.4)	600-2800 561 (600-2.8)	600-3200 561 (600-3.2)
CIRCLING	NOT AUTHORIZED				

TACAN RWY 07

51°26.94'N
004°20.53'E

WOENSDRECHT (EHWO)

CHANGES: EDITORIAL
MIPS

RNLASF 16 APR 2026

**PANS OPS
INSTRUMENT APPROACH CHART**

AD ELEV 63

**RNP RWY 07
WOENSDRECHT (EHWO)**

DUTCH MIL 336.325 125.930		RAPCON WEST 399.725 123.580		WOENSDRECHT TWR 339.000 120.430		GND CTL 356.875 121.680		ATIS*	
EGNOS CHANNEL 99205 E07A	APP COURSE 067°	FAF ALT 2000 FT	Descent GR 5.24% / 3.0°	MDA 600	DA SEE CAT	THR ELEV 39	ALS 420 m	LDA 8012 FT	

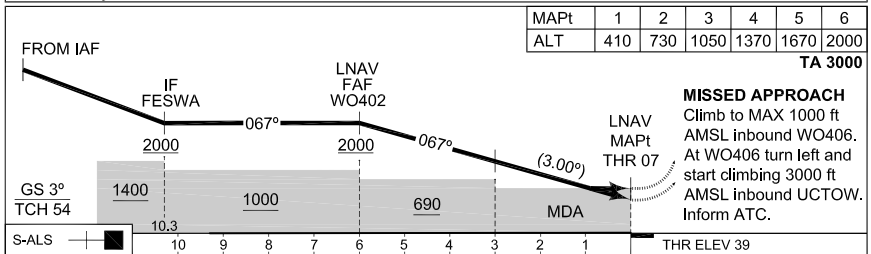
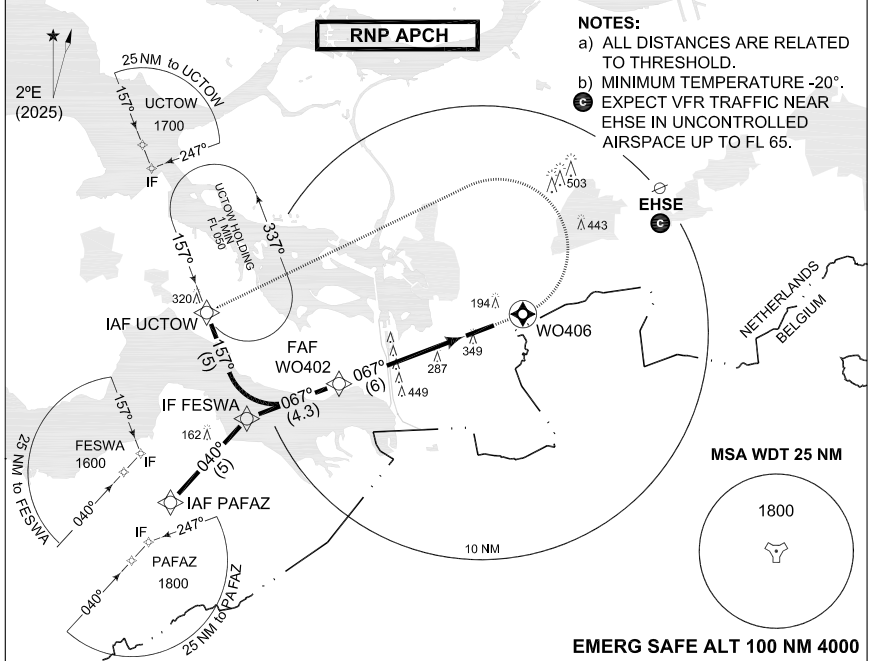

CATEGORY	A	B	C	D
DA(H) LPV	260-800 221 (300-0.8/1.2)	270-800 231 (300-0.8/1.2)	280-800 241 (300-0.8/1.3)	289-800 250 (300-0.8/1.3)
DA(H) LNAV / VNAV	481-1700 442 (500-1.7/2.0)	491-1700 452 (500-1.7/2.1)	501-1800 462 (500-1.8/2.2)	511-1800 472 (500-1.8/2.2)
MDA(H) LNAV	600-2200 561 (600-2.2/2.6)			

IAWP	UCTOW	51°27.72'N	004°01.26'E	FAWP	WO402	51°24.59'N	004°10.59'E
IAWP	PAFAZ	51°19.35'N	003°58.74'E	MAWP	THR 07	51°26.71'N	004°19.54'E
IWP	FESWA	51°23.05'N	004°04.10'E	MATWP	WO406	51°27.65'N	004°23.56'E

RNP RWY 07 51°26.94'N
004°20.53'E **WOENSDRECHT (EHWO)**

CHANGES: EDITORIAL

RNLASF 16 APR 2026

MIPS
INSTRUMENT APPROACH CHART

ILS or LOC RWY 25
WOENDRECHT (EHWO)

AD ELEV 63

DUTCH MIL 336.325 125.930		RAPCON WEST 399.725 123.580		WOENDRECHT TWR 339.000 120.430		GND 356.875 121.680			
TACAN / LOCALIZER / DME WDT CH 97/WDO 108.150/CH 18Y			APP COURSE 247°	GS INTCP ALT 1500 FT	GS 3°	DA SEE CAT	THR ELEV 63	ALS 900 m	LDA 8012 FT

CAUTION:

- a) WHEN TURNING TOWARDS THE ARC, DO NOT EXCEED 10 DME.
- b) RADAR MONITORING MANDATORY

IAF1
51°31.12'N
004°24.76'E

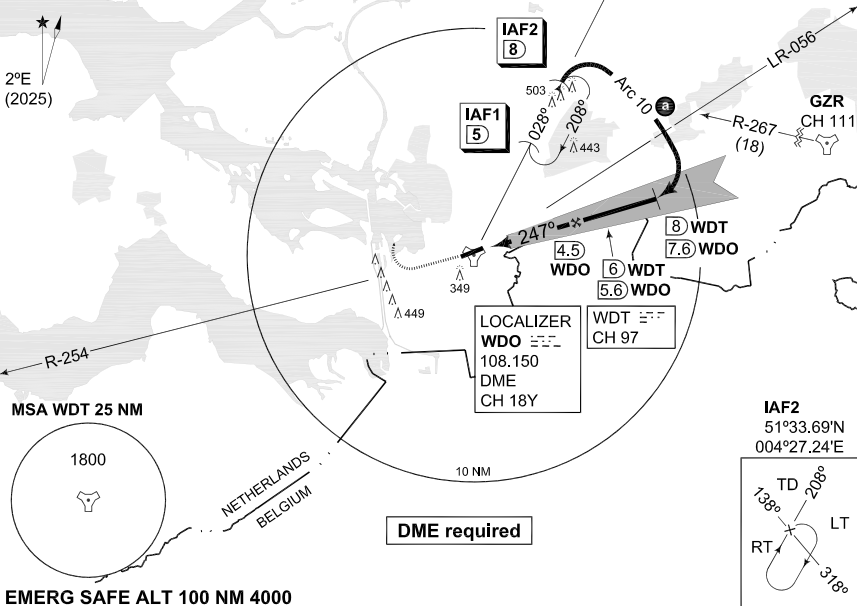

IAF2
51°33.69'N
004°27.24'E

EMERG SAFE ALT 100 NM 4000

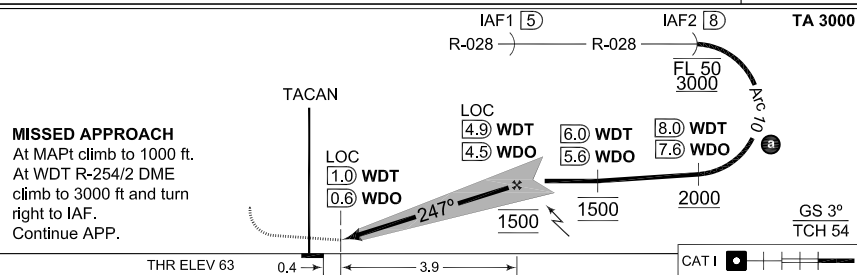

MISSED APPROACH

At MAPt climb to 1000 ft.
At WDT R-254/2 DME climb to 3000 ft and turn right to IAF.
Continue APP.

CATEGORY	A	B	C	D	E
S-ILS 25		263-800 200 (200-0.8)		268-800 205 (300-0.8)	N.A.
S-LOC 25		440-800 377 (400-0.8)		440-1200 377 (400-1.2)	N.A.

ILS or LOC RWY 25

51°26.94'N
004°20.53'E

WOENDRECHT (EHWO)

CHANGES: EDITORIAL

RNLASF 16 APR 2026

MIPS
INSTRUMENT APPROACH CHART

HI-TACAN RWY 25
WOENSDBRECHT (EHWO)

AD ELEV 63

DUTCH MIL 336.325 125.930		RAPCON WEST 399.725 123.580		WOENSDBRECHT TWR 339.000 120.430		GND 356.875 121.680	
TACAN WDT CH 97	APP COURSE 242°	FAF ALT 1200 FT	Descent GR	MDA 440	THR ELEV 63	ALS 900 m	LDA 8012 FT

CAUTION:

- a) DO NOT MANOEUVRE SOUTH OF R-066
- b) RADAR MONITORING MANDATORY

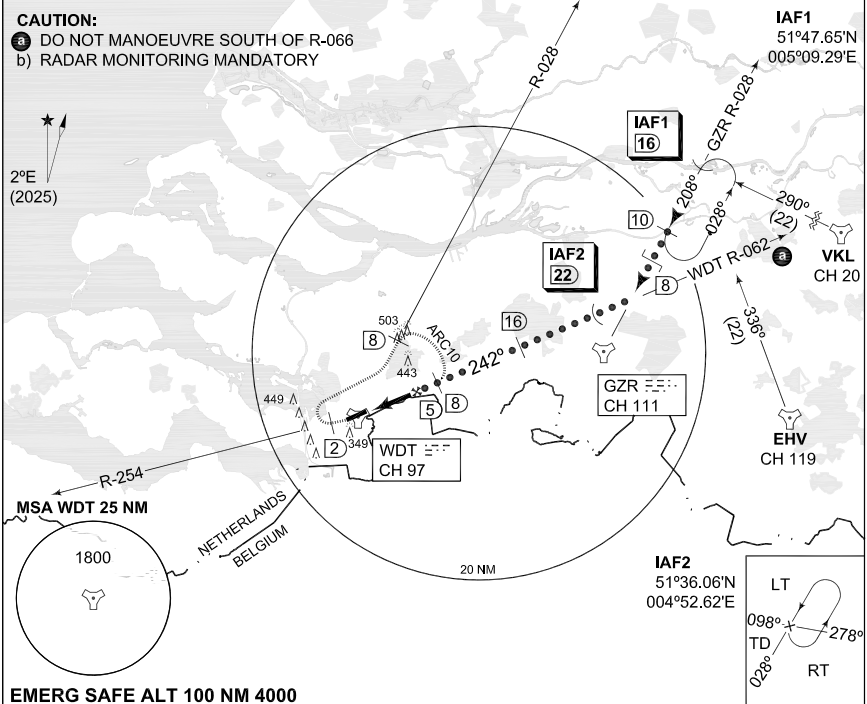

EMERG SAFE ALT 100 NM 4000

MISSED APPROACH

At MAPt climb to 1000 ft.
At R-254/2 DME climb to 3000 ft and turn right. Intercept R-028 outbound. Intercept R/H Arc 10. Descent to 2000 ft. Intercept R-062 inbound. Continue APP.

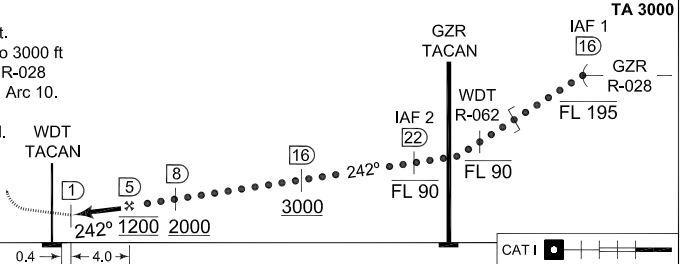

CATEGORY	A	B	C	D	E
S-TACAN 25	440-800 377 (400-0.8)			440-1200 377 (400-1.2)	
CIRCLING	NOT AUTHORIZED				

CHANGES: EDITORIAL

HI-TACAN RWY 25

51°26.94'N
004°20.53'E

WOENSDBRECHT (EHWO)

RNLASF 16 APR 2026

MIPS
INSTRUMENT APPROACH CHART

TACAN RWY 25
WOENS DreCHT (EHWO)

AD ELEV 63

DUTCH MIL 336.325 125.930		RAPCON WEST 399.725 123.580		WOENS DreCHT TWR 339.000 120.430		GND 356.875 121.680	
TACAN WDT CH 97	APP COURSE 242°	FAF ALT 1200 FT	Descent GR	MDA 440	THR ELEV 63	ALS 900 m	LDA 8012 FT

CAUTION:

- a) WHEN TURNING TOWARDS THE ARC, DO NOT EXCEED 10 DME
- b) DO NOT MANOEUVRE SOUTH OF R-066
- c) RADAR MONITORING MANDATORY

IAF1
51°31.12'N
004°24.76'E

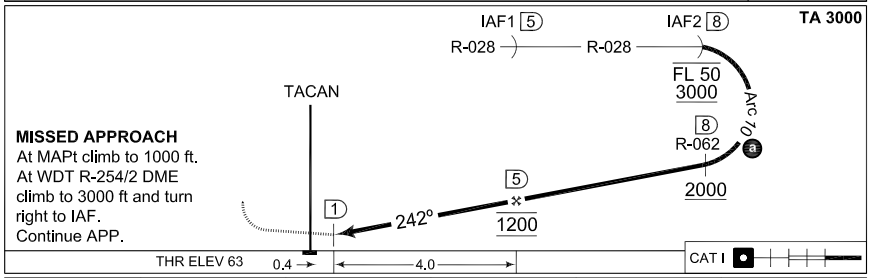
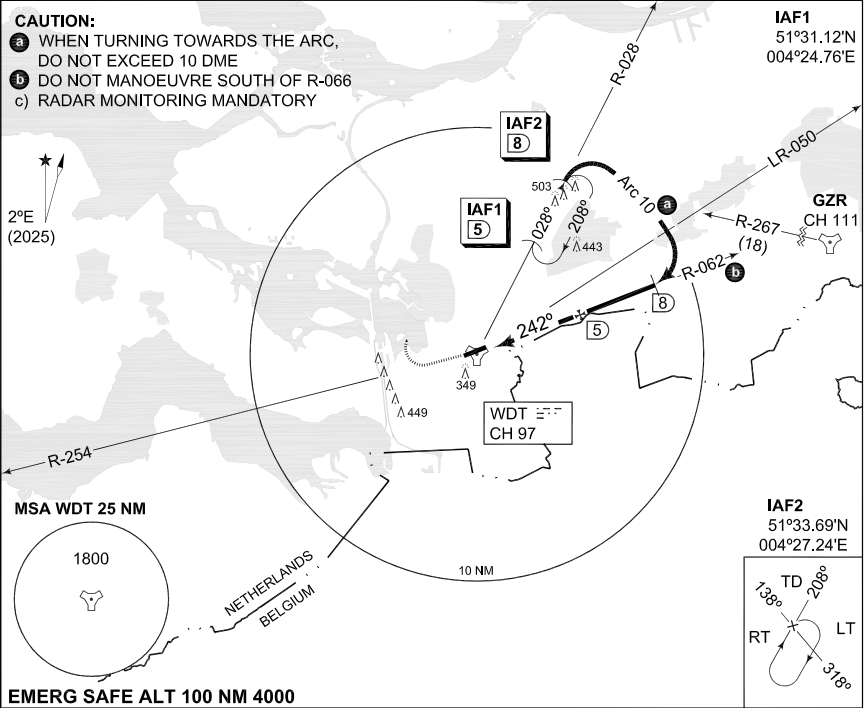

CATEGORY	A	B	C	D	E
S-TACAN 25	440-800 377 (400-0.8)			440-1200 377 (400-1.2)	
CIRCLING	NOT AUTHORIZED				

CHANGES: EDITORIAL

TACAN RWY 25

51°26.94'N
004°20.53'E

WOENS DreCHT (EHWO)

RNLASF 16 APR 2026

**PANS OPS
INSTRUMENT APPROACH CHART**

AD ELEV 63

**RNP RWY 25
WOENSDRECHT (EHWO)**

DUTCH MIL 336.325 125.930		RAPCON WEST 399.725 123.580		WOENSDRECHT TWR 339.000 120.430		GND CTL 356.875 121.680		ATIS*	
EGNOS CHANNEL 51845 E25A	APP COURSE 247°	FAF ALT 2000 FT	Descent GR 5.24% / 3.0°	MDA SEE CAT	DA SEE CAT	THR ELEV 63	ALS 900 m	LDA 8012 FT	

NOTES:

- a) ALL DISTANCES ARE RELATED TO THRESHOLD.
- b) MINIMUM TEMPERATURE -20°.
- c) EXPECT VFR TRAFFIC NEAR EHSE IN UNCONTROLLED AIRSPACE UP TO FL 65.

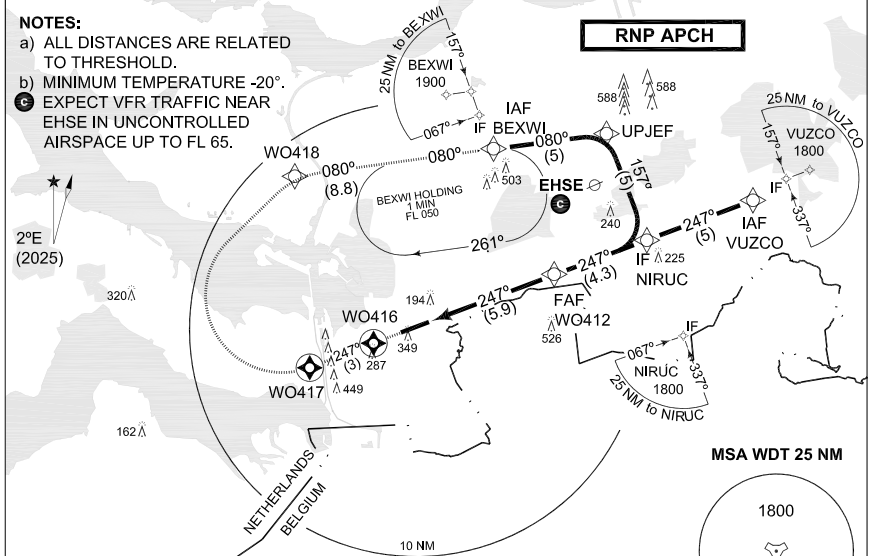

MISSED APPROACH

Climb to MAX 1000 ft AMSL to WO416. Climb to 3000 ft AMSL to WO417. At WO417 turn right to WO418 and proceed to BEXWI. Inform ATC.

EMERG SAFE ALT 100 NM 4000

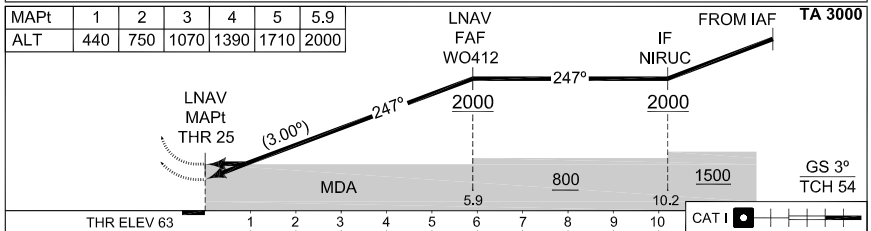

EU-OPS	CATEGORY	A		B		C		D	
		DA(H)	LPV	DA(H)	LPV	DA(H)	LPV	DA(H)	LPV
	DA(H) LPV	284	-550 221 (300-0.8/1.2)	294	-550 231 (300-0.8/1.2)	303	-550 240 (300-0.8/1.2)	313	-550 250 (300-0.8/1.3)
	DA(H) LNAV / VNAV	321	-600 258 (300-0.8/1.3)	331	-600 268 (300-0.8/1.3)	352	-650 289 (300-0.8/1.4)	379	-700 316 (400-0.8/1.4)
	MDA(H) LNAV	440-1000 377 (400-1.0/1.7)				450-1100 387 (400-1.1/1.8)		470-1200 407 (500-1.2/1.9)	
	IAWP	VUZO	51°32.51'N	004°44.39'E	MAWP	THR25	51°27.17'N	004°21.52'E	
	IAWP	BEXWI	51°34.79'N	004°26.14'E	MATWP	WO416	51°26.25'N	004°17.60'E	
	WP	UPJEF	51°35.44'N	004°34.09'E	MATWP	WO417	51°25.19'N	004°13.12'E	
	IWP	NIRUC	51°30.76'N	004°36.89'E	MATWP	WO418	51°33.61'N	004°12.09'E	
	FAWP	WO412	51°29.25'N	004°30.37'E	MAHF	BEXWI	51°34.79'N	004°26.14'E	

RNP RWY 25

51°26.94'N
004°20.53'E

WOENSDRECHT (EHWO)

CHANGES: EDITORIAL

RNLASF 16 APR 2026

INSTRUMENT DEPARTURE OR APPROACH PROCEDURE CHARTS RATE OF CLIMB/DESCENT TABLE

A rate of climb/descent table (ft per min.) is provided for use in planning and executing climbs or descents under known or approximate ground speed conditions.

CLIMB / DESCENT			Ground Speed (knots)										
ANGLE	PERCENT	FT/NM	60	90	120	150	180	210	240	270	300	330	360
1.5	2.6%	160	160	240	320	400	480	560	640	720	800	880	960
2.0	3.5%	220	220	320	430	530	640	750	850	960	1060	1170	1280
2.5	4.4%	270	270	400	530	670	800	930	1070	1200	1330	1460	1600
3.0	5.2%	320	320	480	640	800	960	1120	1280	1440	1600	1760	1910
3.5	6.1%	380	380	560	750	930	1120	1300	1490	1680	1860	2050	2230
4.0	7.0%	430	430	640	850	1070	1280	1490	1700	1920	2130	2340	2550
4.5	7.9%	480	480	720	960	1200	1440	1680	1920	2160	2390	2630	2870
5.0	8.7%	540	540	800	1070	1330	1600	1860	2130	2400	2660	2930	3190
5.5	9.6%	590	590	880	1170	1470	1760	2050	2340	2640	2930	3220	3510
6.0	10.5%	640	640	960	1280	1600	1920	2240	2560	2880	3200	3520	3840
6.5	11.4%	700	700	1040	1390	1730	2080	2430	2770	3120	3470	3810	4160
7.0	12.3%	750	750	1120	1500	1870	2240	2620	2990	3360	3730	4110	4480
7.5	13.2%	800	800	1200	1600	2000	2400	2800	3200	3600	4000	4400	4800
8.0	14.1%	860	860	1280	1710	2140	2570	2990	3420	3850	4270	4700	5130
8.5	14.9%	910	910	1370	1820	2270	2730	3180	3640	4090	4540	5000	5450
9.0	15.8%	970	970	1450	1930	2410	2890	3370	3850	4330	4820	5300	5780
9.5	16.7%	1020	1020	1530	2040	2550	3050	3560	4070	4580	5090	5600	6100
10.0	17.6%	1080	1080	1610	2150	2680	3220	3750	4290	4830	5360	5900	6430

